

Durex® Insulite Select

Advanced High Thermal Resistance Drained &
Moisture Managed EIFS (Adhered)

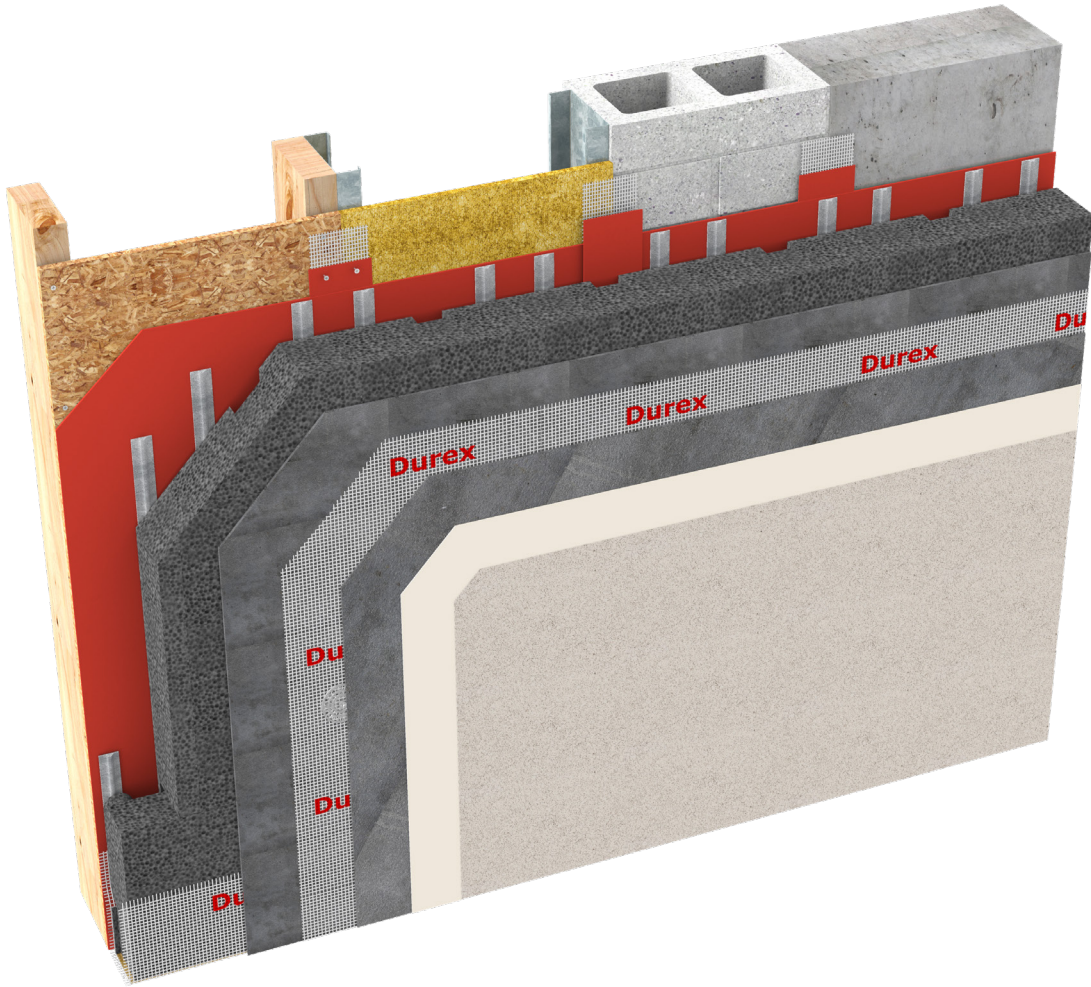

CCMC 13103-R
CAN/ULC S716.1 Materials
CAN/ULC S716.2 Installations
CAN/ULC S716.3 Design Application

G.D.D.C Factor = 25%
C.I Factor = 0.80 RSI/Inch Type 1 EPS



High Thermal
Resistance



LEED Compliant



Eco-Friendly



Drained

Protect. Enhance. Outperform.

DURabond 
1-877-387-2266 info@durabond.com
www.durabond.com

SYSTEM DETAILS

Durex® Insulite Select

Exterior Insulation and Finish System

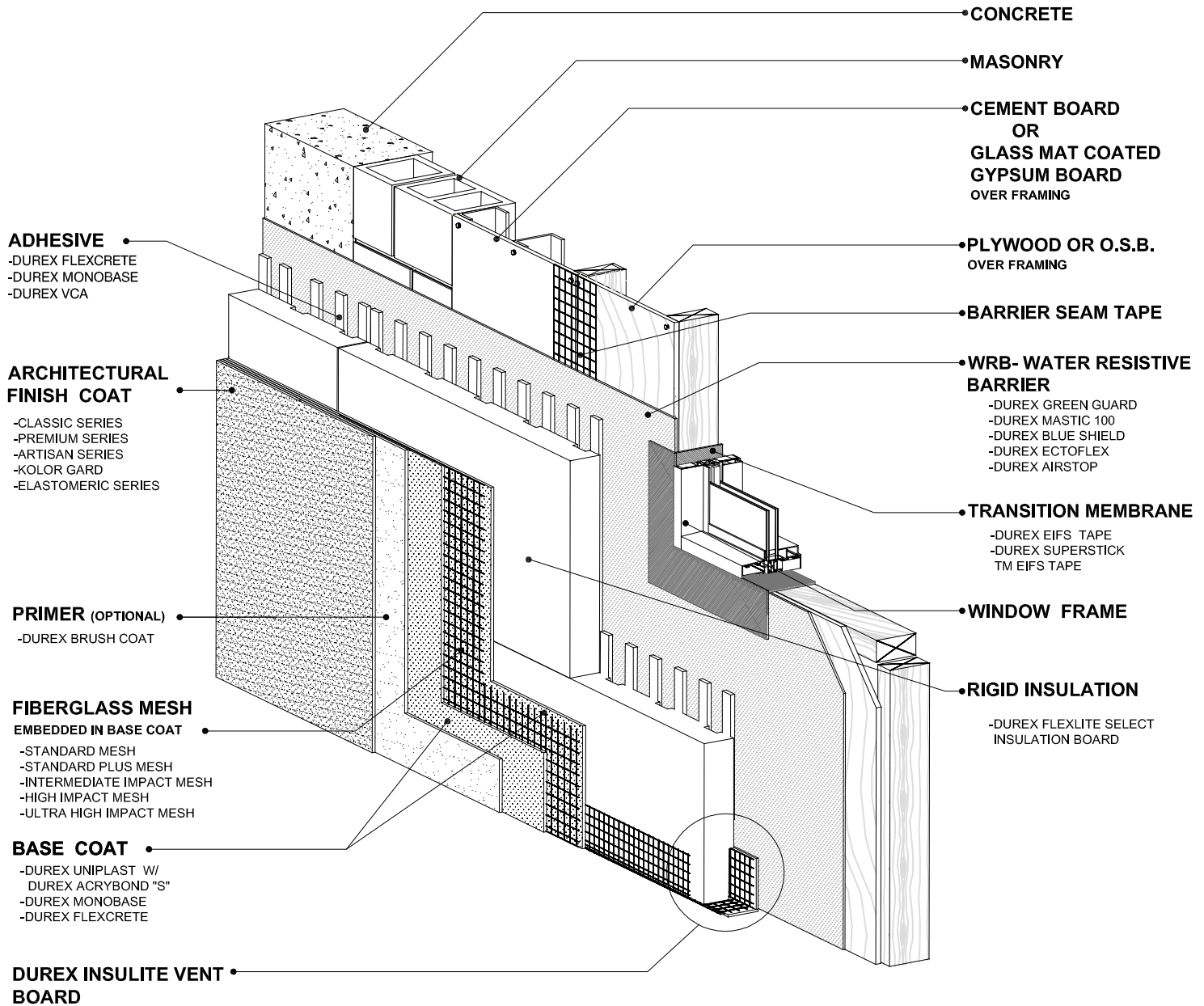

DURABOND

1-877-387-2266 - info@durabond.com - www.durabond.com

Durabond details are offered to assist in the development of project specific details; principles and variables incorporated in all details are the sole responsibility of the project professional(s).

*System Isometric
& Components*

OUTSIDE CORNER DETAIL

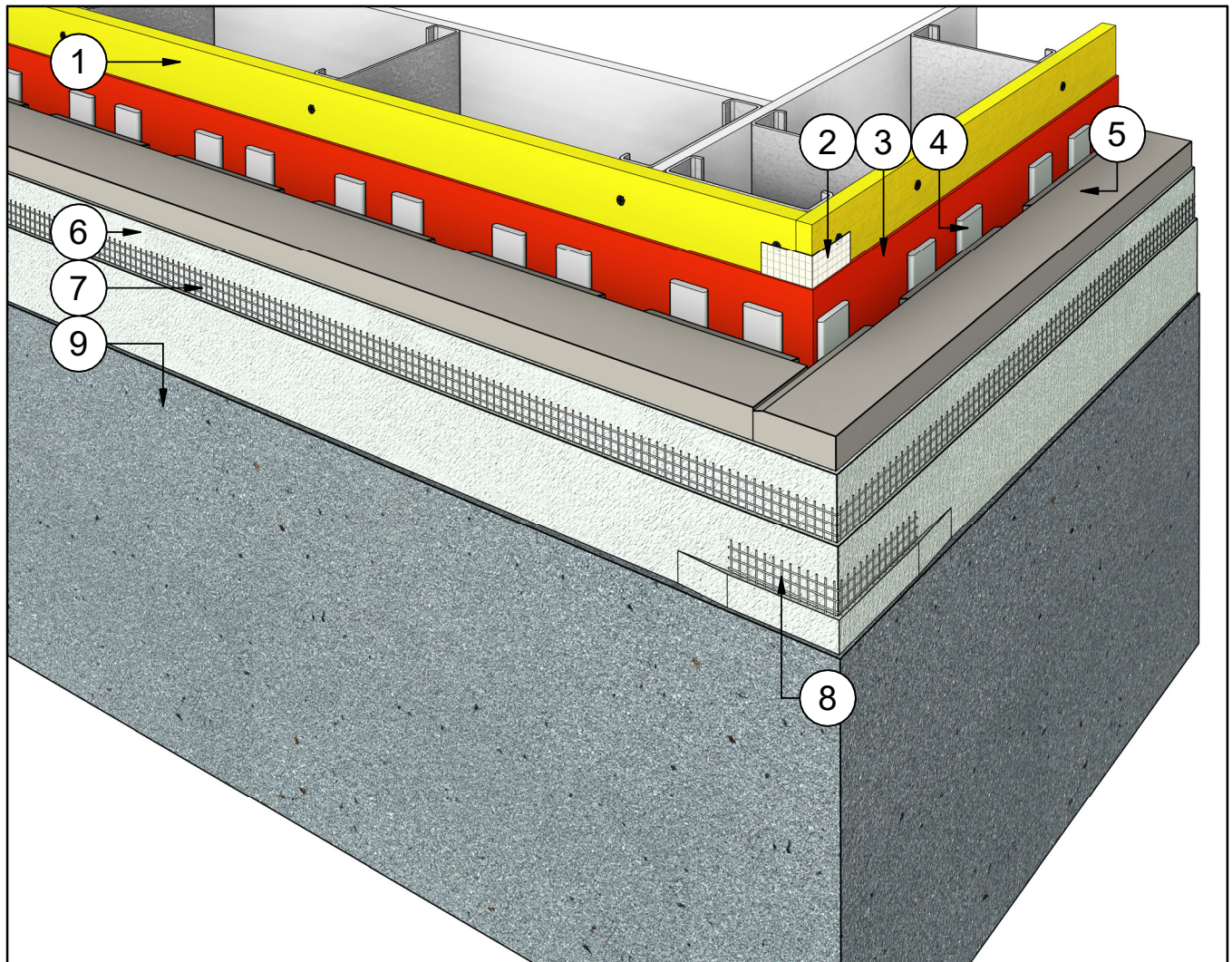

Note Text

- 1 Steel Studs Frame & Sheathing
- 2 Barrier Seam Tap (Embedded in WRB.)
- 3 WRB - Water Resistant Barrier
- 4 Insulation Adhesive
- 5 Insulite Select Insulation Board
- 6 Base Coat
- 7 Fibreglass Reinforcing Mesh (Embedded in WRB)
- 8 Fibreglass Corner Mesh (Embedded in WRB)
- 9 Finish Coat



Durabond details are offered to assist in the development of project specific details; principles and variables incorporated in all details are the sole responsibility of the project professional(s).

OUTSIDE CORNER DETAIL

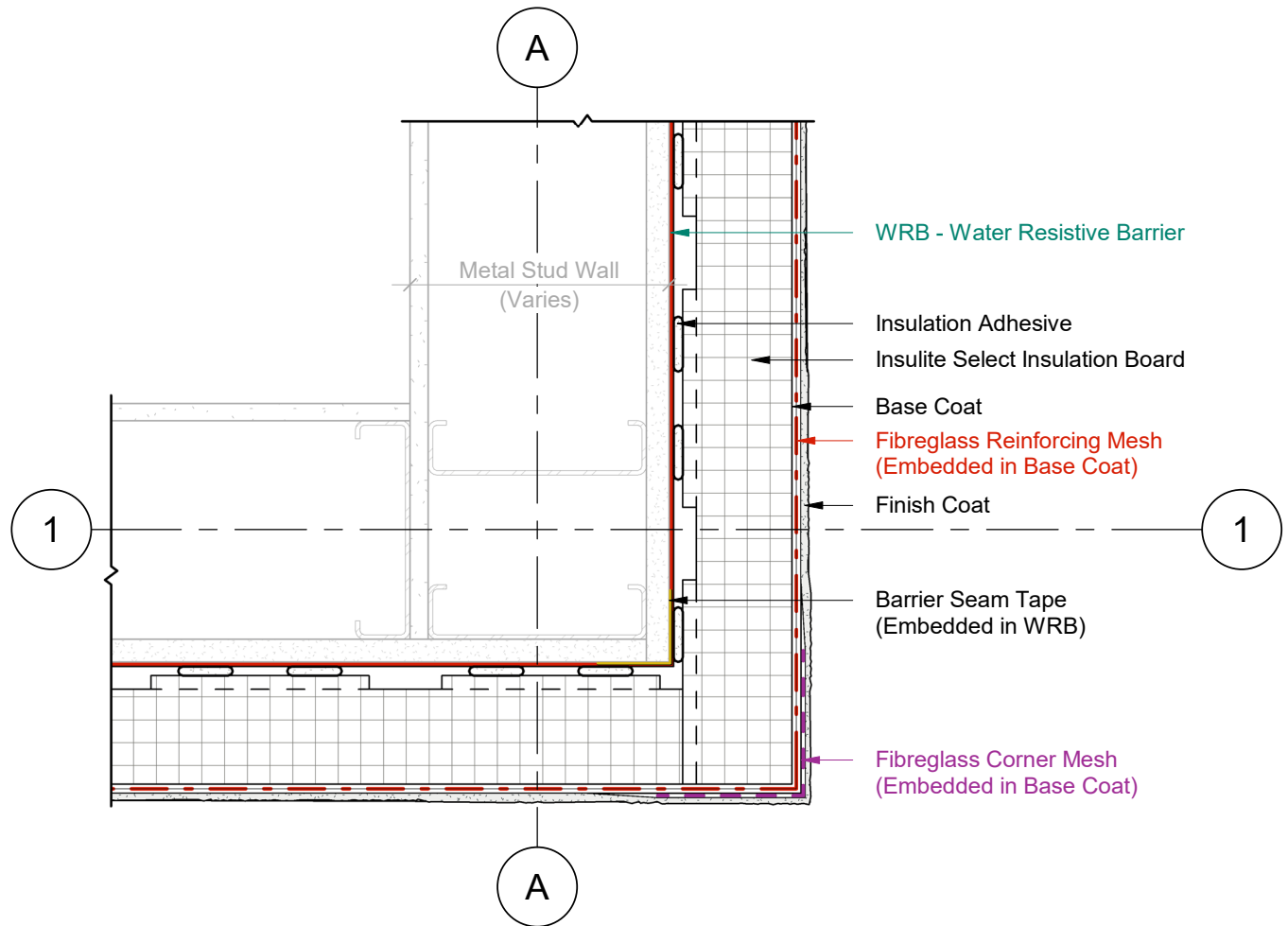

1 Plan Detail
2 Scale = 1:5

Durabond details are offered to assist in the development of project specific details; principles and variables incorporated in all details are the sole responsibility of the project professional(s).

INSIDE CORNER DETAIL

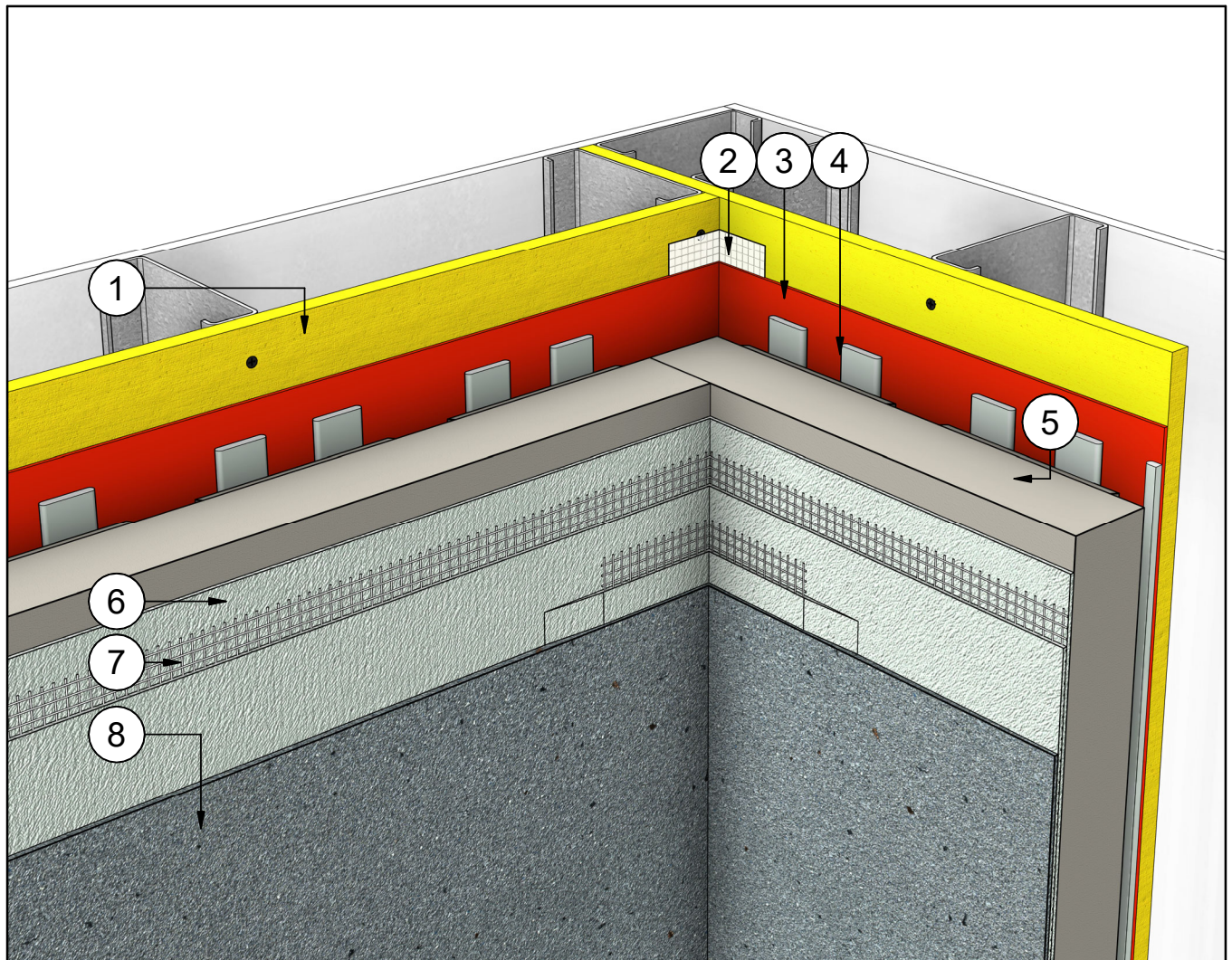

Note Text

- 1 Steel Studs Frame & Sheathing
- 2 Barrier Seam Tap (Embedded in WRB.)
- 3 WRB - Water Resistive Barrier
- 4 Insulation Adhesive
- 5 Insulite Select Insulation Board
- 6 Base Coat
- 7 Fiberglass Reinforcing Mesh (Embedded in WRB)
- 8 Finish Coat



Durabond details are offered to assist in the development of project specific details; principles and variables incorporated in all details are the sole responsibility of the project professional(s).

INSIDE CORNER DETAIL

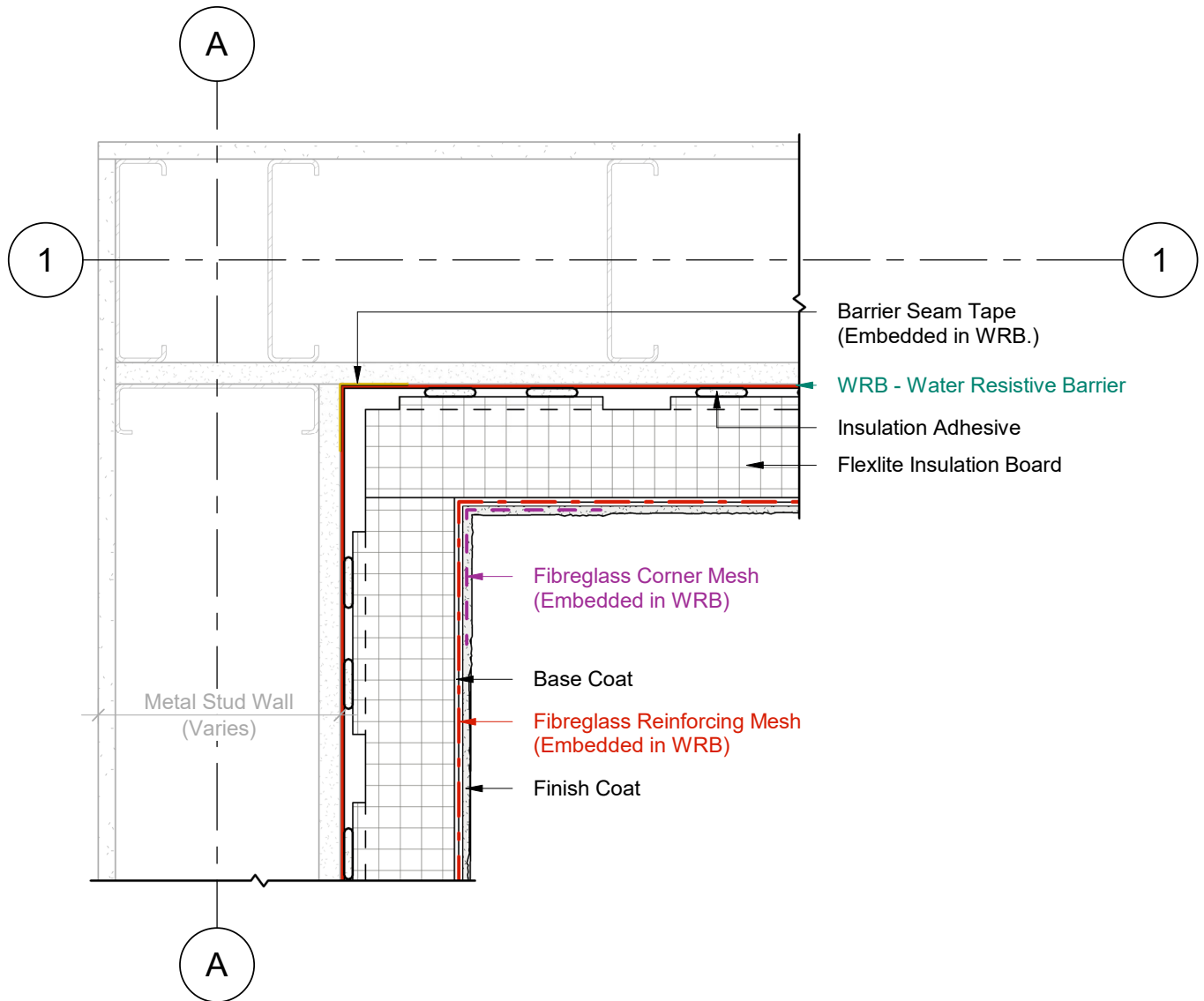

1 Plan Detail
2 Scale = 1:5



Durabond details are offered to assist in the development of project specific details; principles and variables incorporated in all details are the sole responsibility of the project professional(s).

VERTICAL EXPANSION JOINT

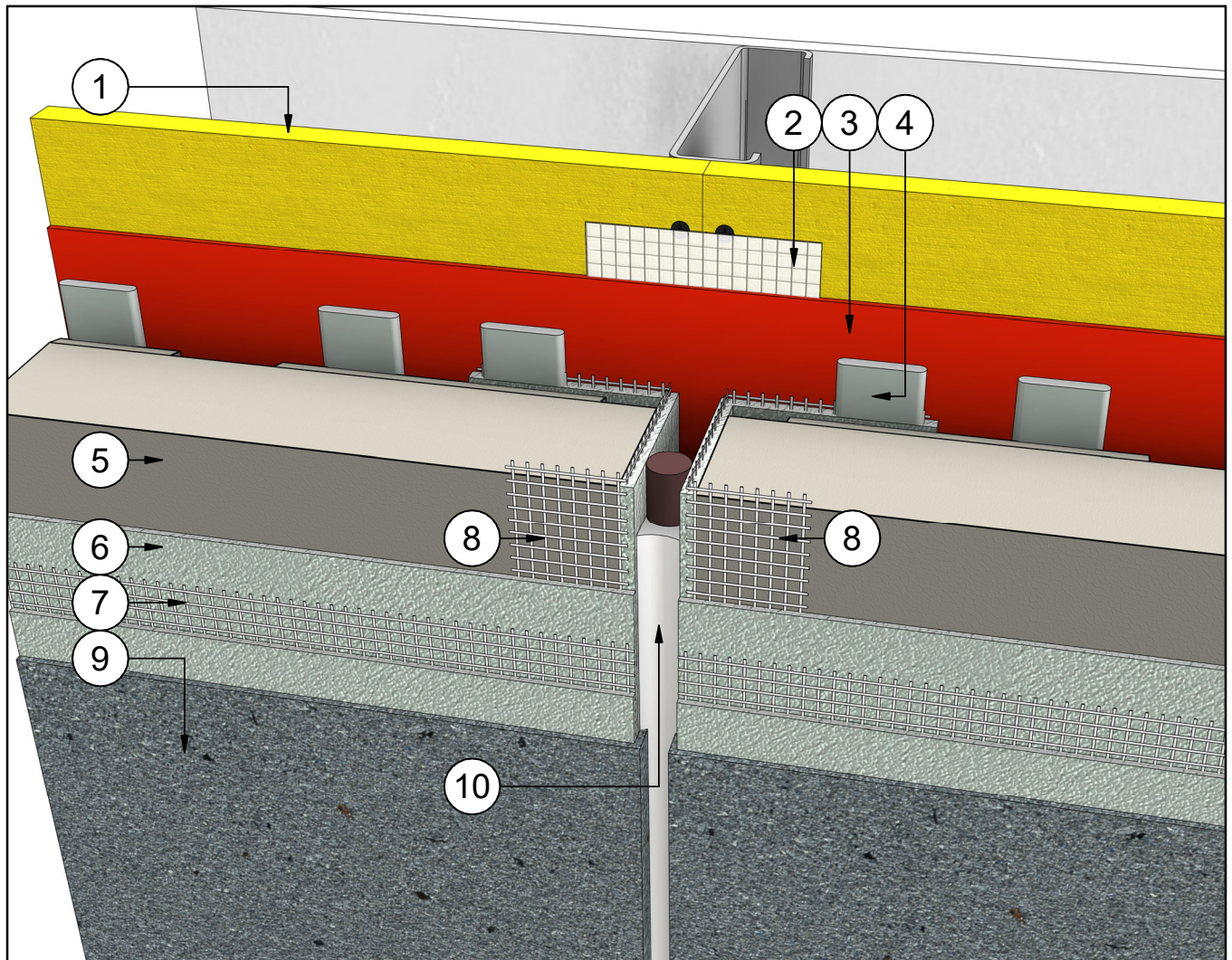

Note Text

- 1 Steel Studs Frame & Sheathing
- 2 Barrier Seam Tap (Embedded in WRB.)
- 3 WRB - Water Resistive Barrier
- 4 Insulation Adhesive
- 5 Insulite Select Insulation Board
- 6 Base Coat
- 7 Fibreglass Reinforcing Mesh (Embedded in WRB)
- 8 Fibreglass Corner Mesh (Embedded in WRB)
- 9 Finish Coat
- 10 Backer Rod & Sealant



Durabond details are offered to assist in the development of project specific details; principles and variables incorporated in all details are the sole responsibility of the project professional(s).

VERTICAL EXPANSION JOINT

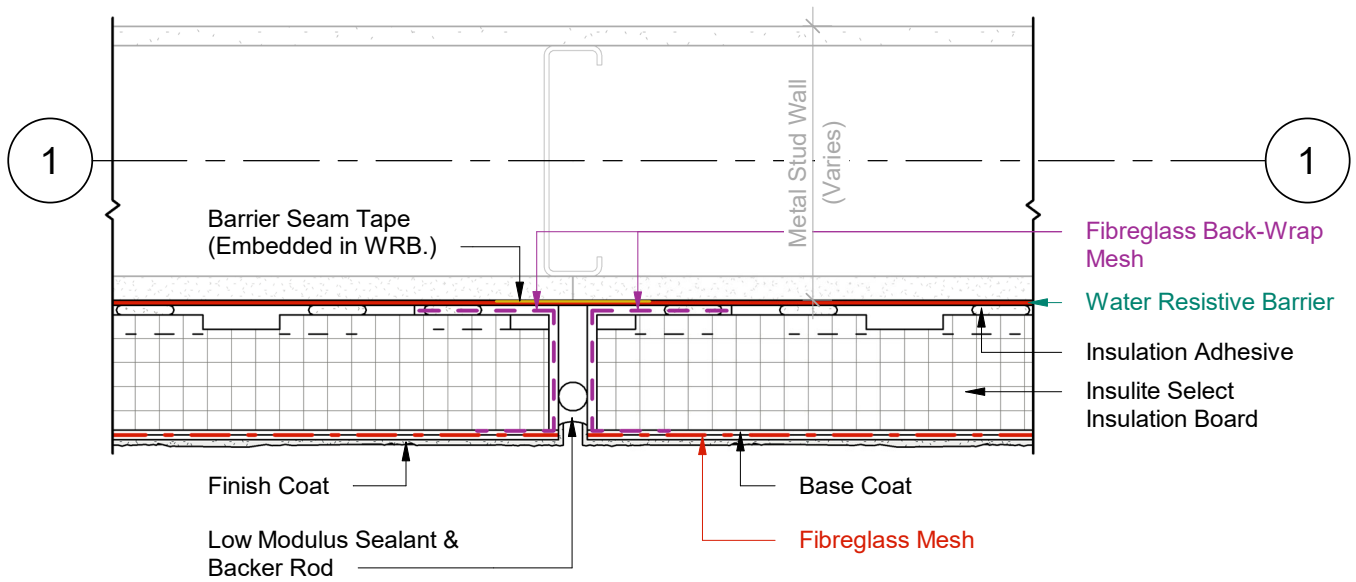

1 Plan Detail
2 Scale = 1:5



Durabond details are offered to assist in the development of project specific details; principles and variables incorporated in all details are the sole responsibility of the project professional(s).

HORIZONTAL EXPANSION JOINT

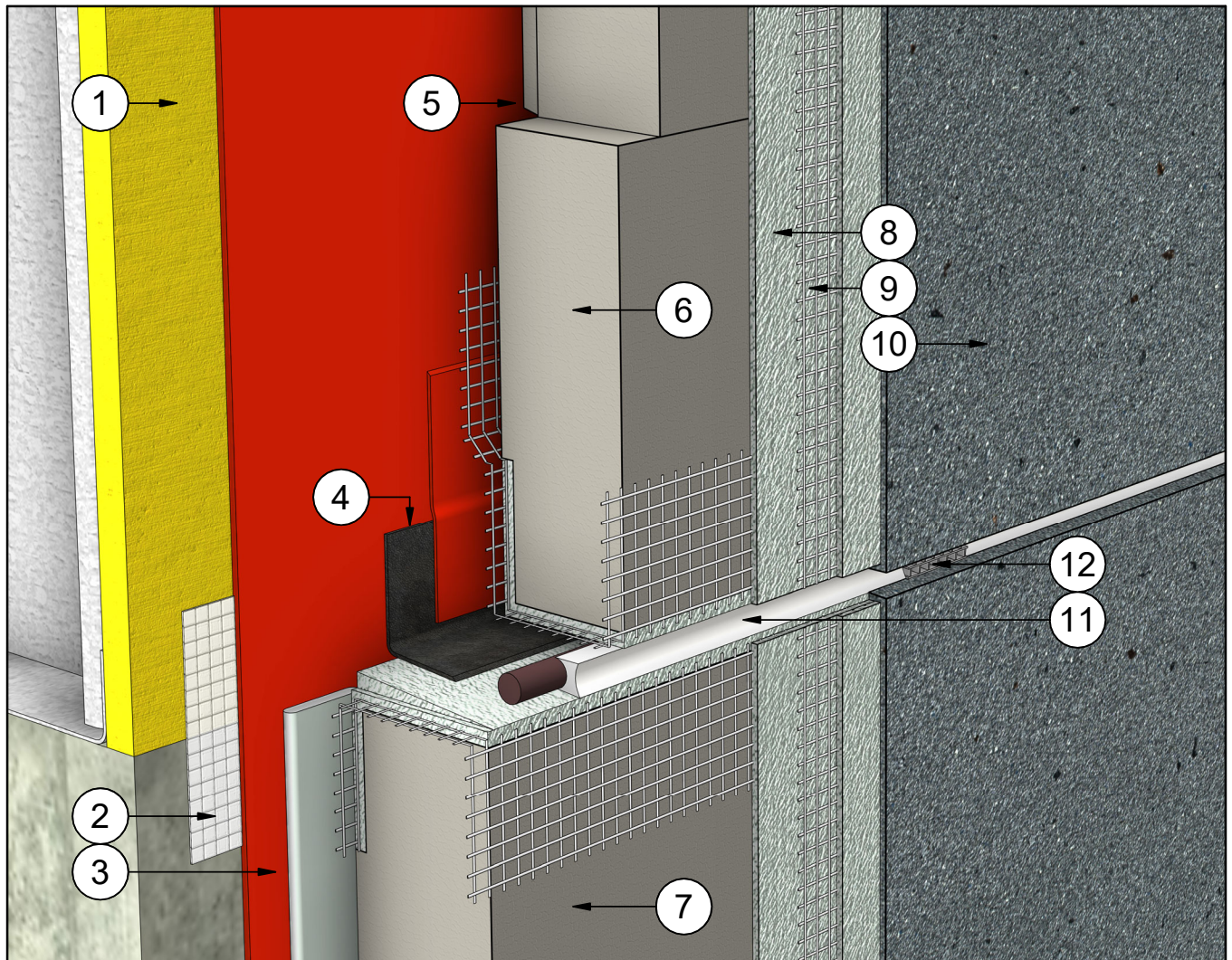

Note Text

- 1 Steel Studs Frame & Sheathing
- 2 Barrier Seam Tap (Embedded in WRB.)
- 3 WRB - Water Resistive Barrier
- 4 Tie in Membrane & Primer
- 5 Insulation Adhesive
- 6 Insulite Select Vent Board
- 7 Insulite Select Boundary Board
- 8 Base Coat
- 9 Fibreglass Reinforcing Mesh (Embedded in WRB)
- 10 Finish Coat
- 11 Backer Rod & Sealant
- 12 Sealant Vent

DURabond.

Durabond details are offered to assist in the development of project specific details; principles and variables incorporated in all details are the sole responsibility of the project professional(s).

HORIZONTAL EXPANSION JOINT

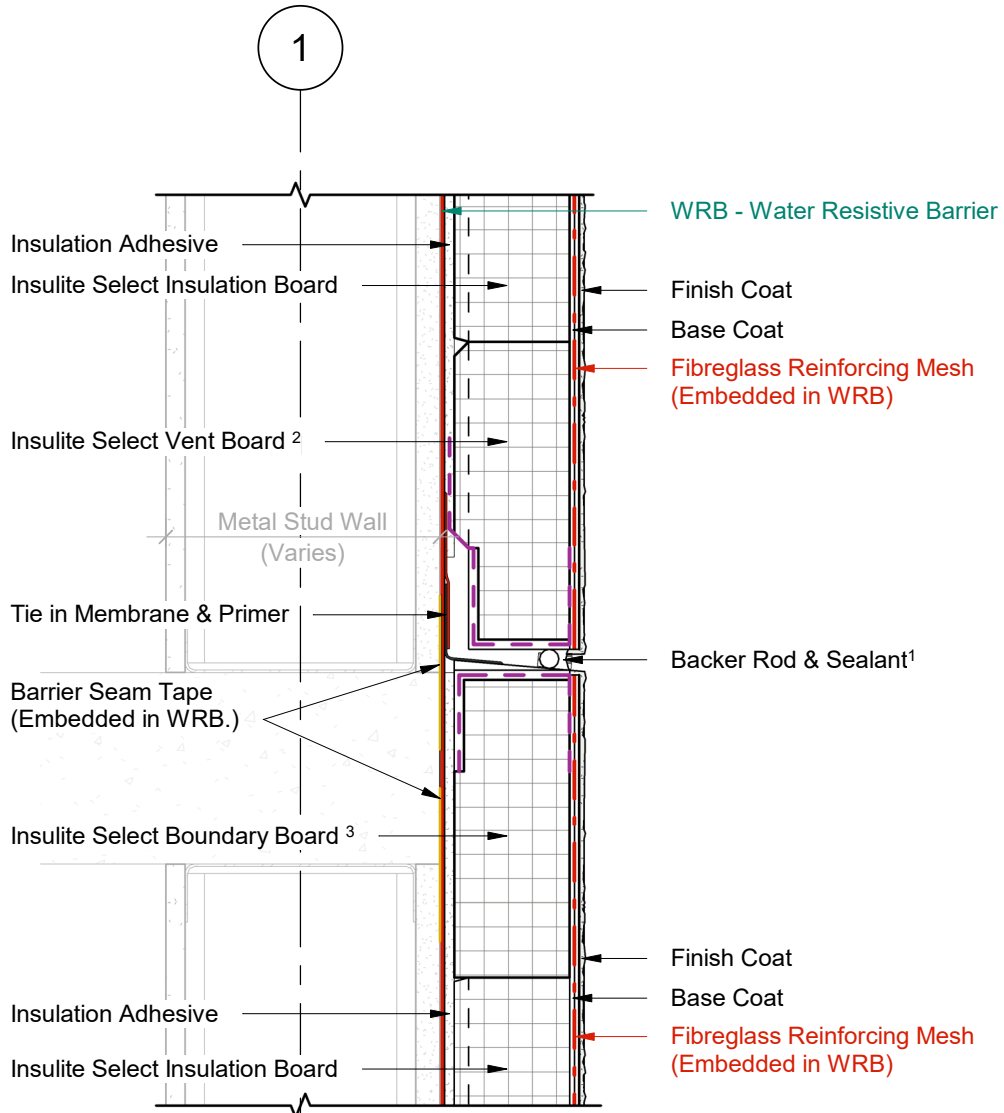

1 Wall Section
2 Scale = 1 : 5

- 1 Provide venting on Backer Rod & Sealant every 48" (1200mm) O.C. minimum.
- 2 Insulite Select Vent Board includes vertical drainage channels & a 2.5" (64mm) back wrapped mesh that is adhered to the board with a Base Coat layer.
- 3 Insulite Select Boundary Board includes a 2.5" (64mm) back wrapped mesh that is adhered to the board with a Base Coat layer.

DURabond.

Durabond details are offered to assist in the development of project specific details; principles and variables incorporated in all details are the sole responsibility of the project professional(s).

HORIZONTAL EXPANSION JOINT

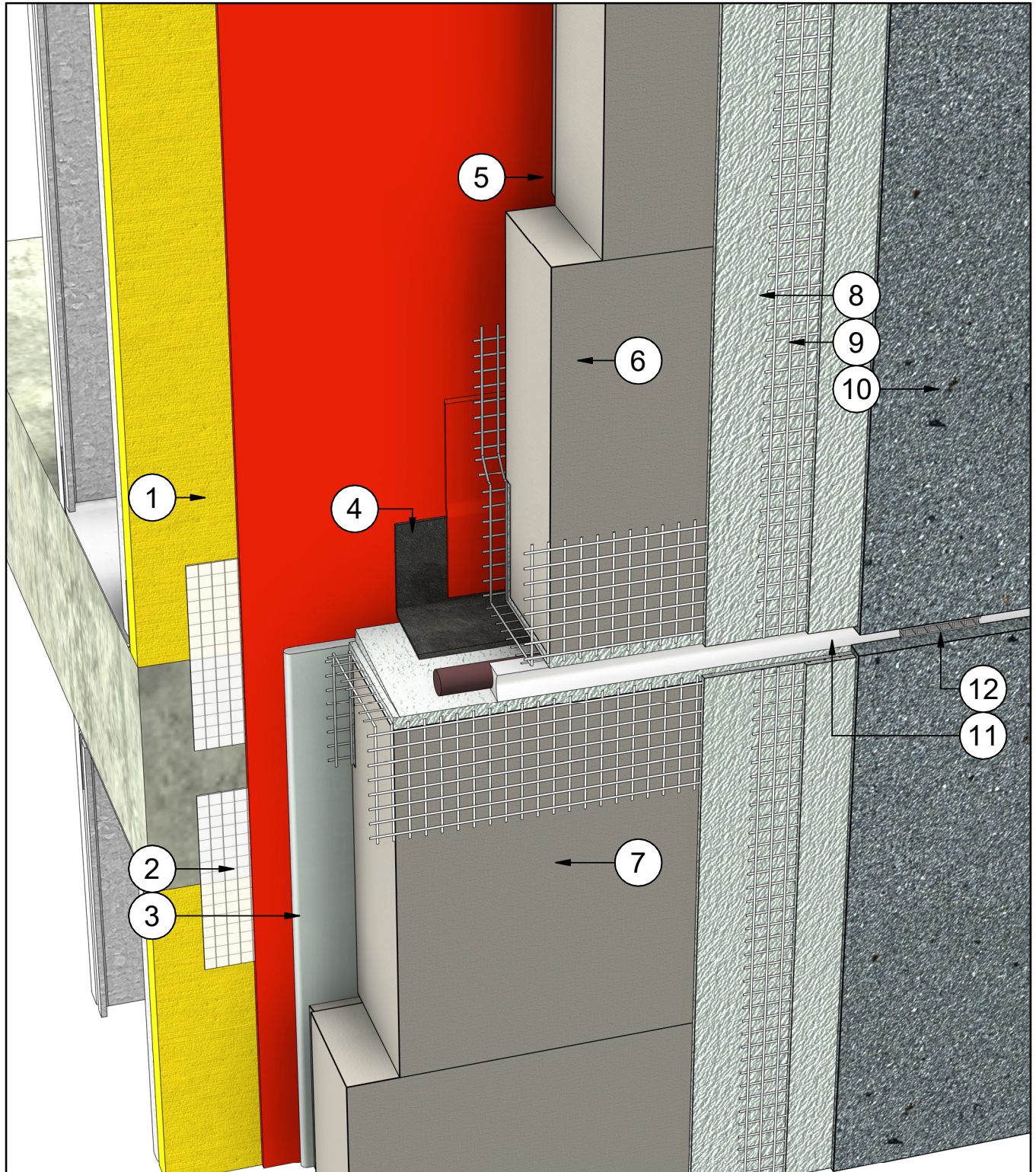

DURabond.

Durabond details are offered to assist in the development of project specific details; principles and variables incorporated in all details are the sole responsibility of the project professional(s).

TERMINATION AT MASONRY SILL

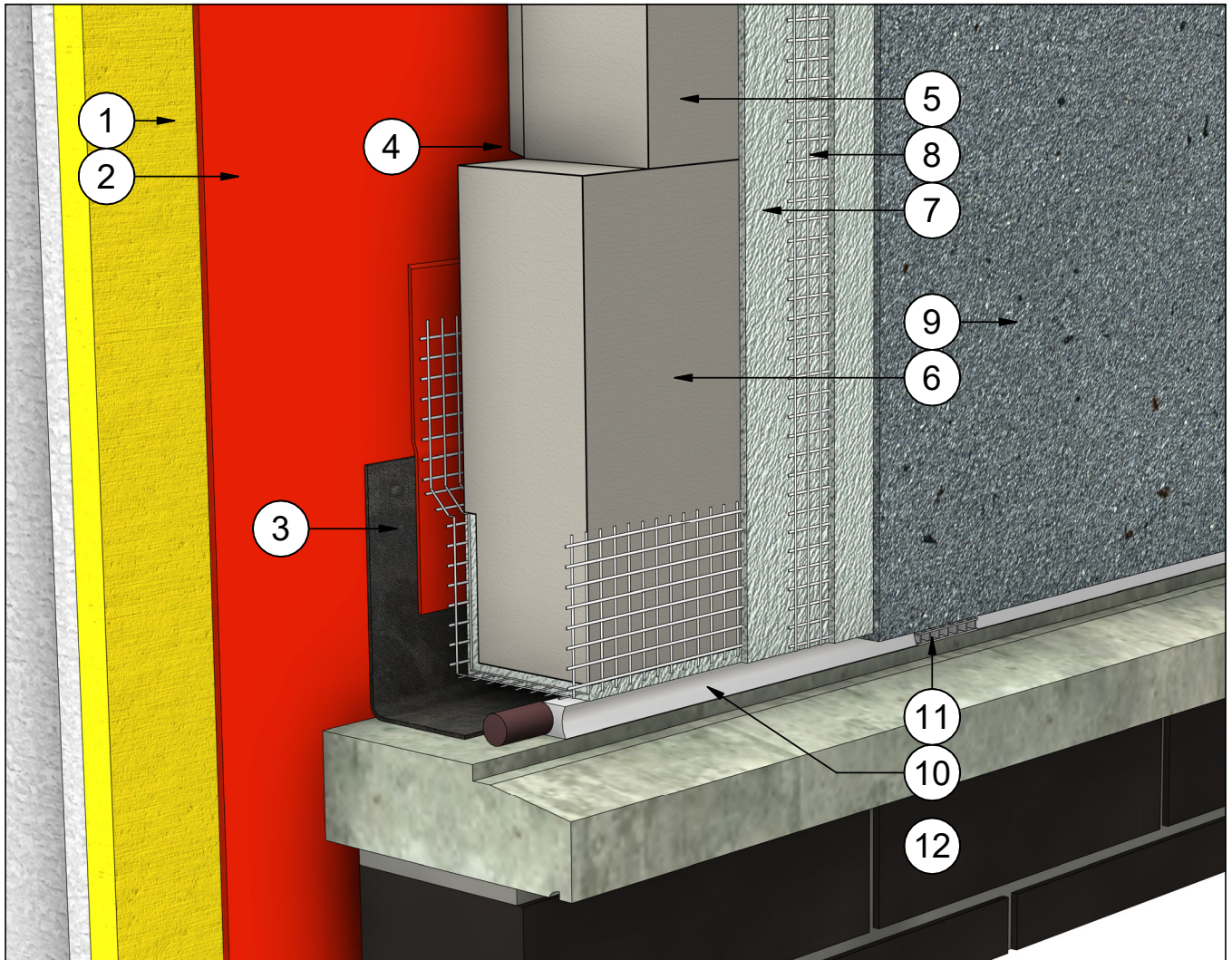

#	Note Text	#	Note Text
1	Steel Studs Framing & Sheathing	8	Fibreglass Reinforcing Mesh (Embedded in Base Coat)
2	WRB - Water Resitive Barrier	9	Finish Coat
3	Tie In Membrane & Primer	10	Backer Rod & Sealant
4	Insulation Adhesive	11	Sealant Vent
5	Insulite Select Insulation Board	12	Alternate Cladding
6	Insulite Select Vent Board		
7	Base Coat		



Durabond details are offered to assist in the development of project specific details; principles and variables incorporated in all details are the sole responsibility of the project professional(s).

TERMINATION AT MASONRY SILL

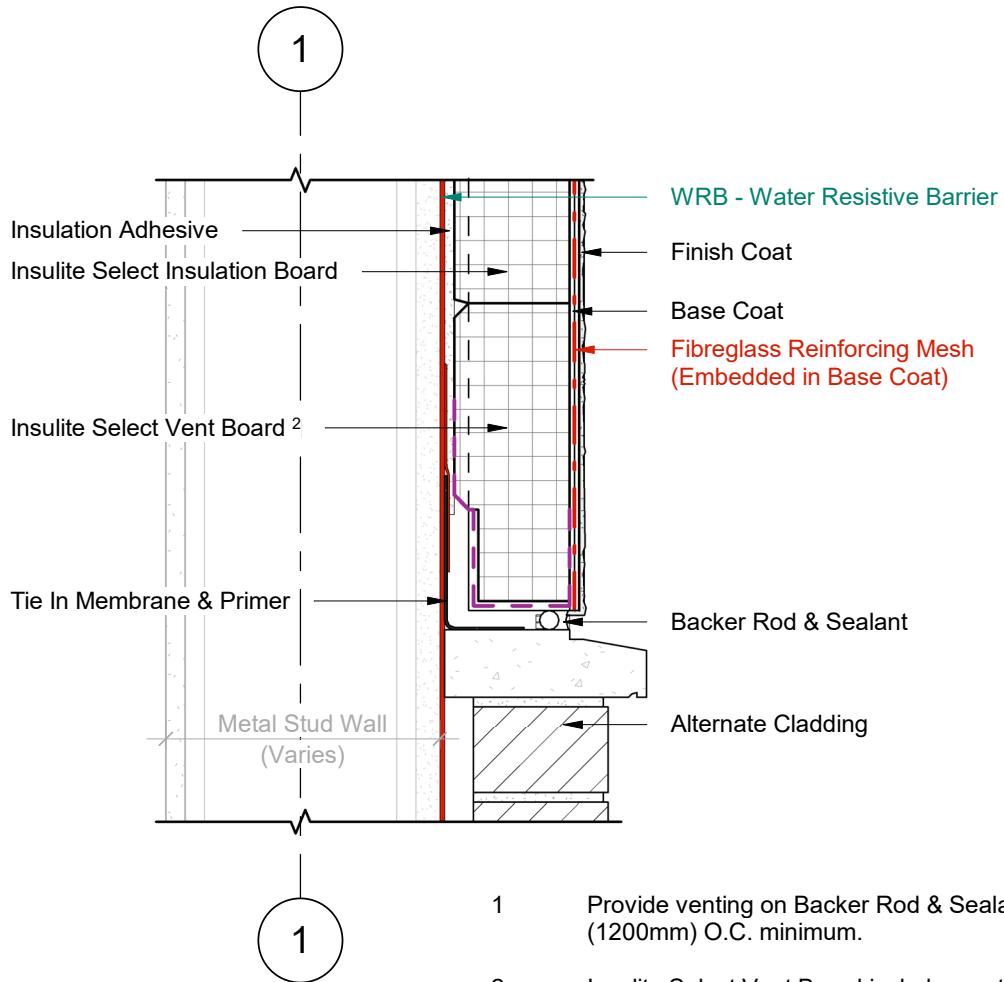

1 Wall Section
2 Scale = 1 : 5

- 1 Provide venting on Backer Rod & Sealant every 48" (1200mm) O.C. minimum.
- 2 Insulite Select Vent Board includes vertical drainage channels & a 2.5" (64mm) back wrapped mesh that is adhered to the board with a Base Coat layer.

TERMINATION AT CURB

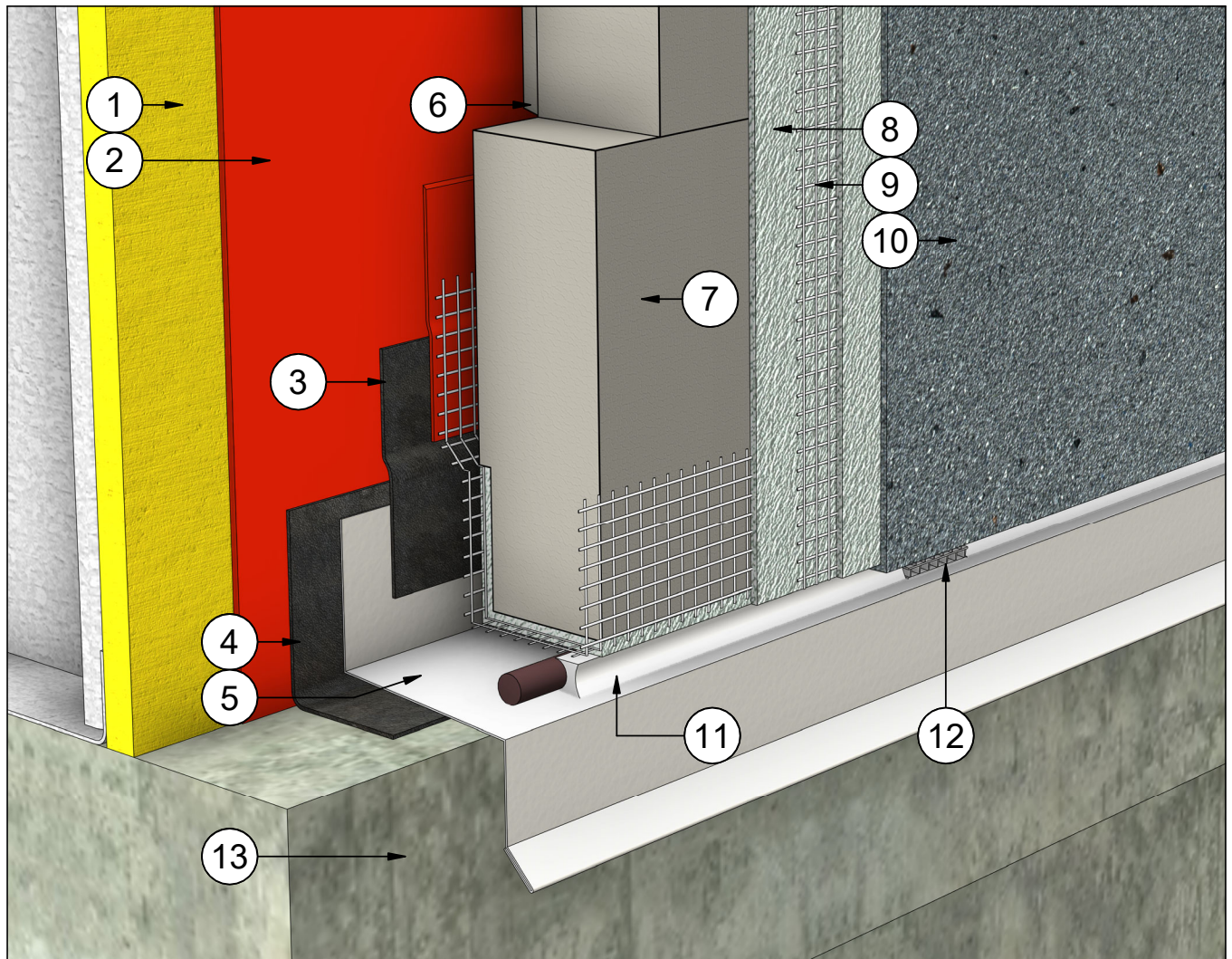

#	Note Text	#	Note Text
1	Steel Studs Framing & Sheathing	8	Base Coat
2	WRB - Water Resitive Barrier	9	Fibreglass Reinforcing Mesh (Embedded in Base Coat)
3	Tie In Membrane & Primer	10	Finish Coat
4	Tie In Membrane	11	Backer Rod & Sealant
5	Flashing	12	Sealant Vent
6	Insulation Adhesive	13	Curb
7	Insulite Select Vent Board		



Durabond details are offered to assist in the development of project specific details; principles and variables incorporated in all details are the sole responsibility of the project professional(s).

TERMINATION AT CURB

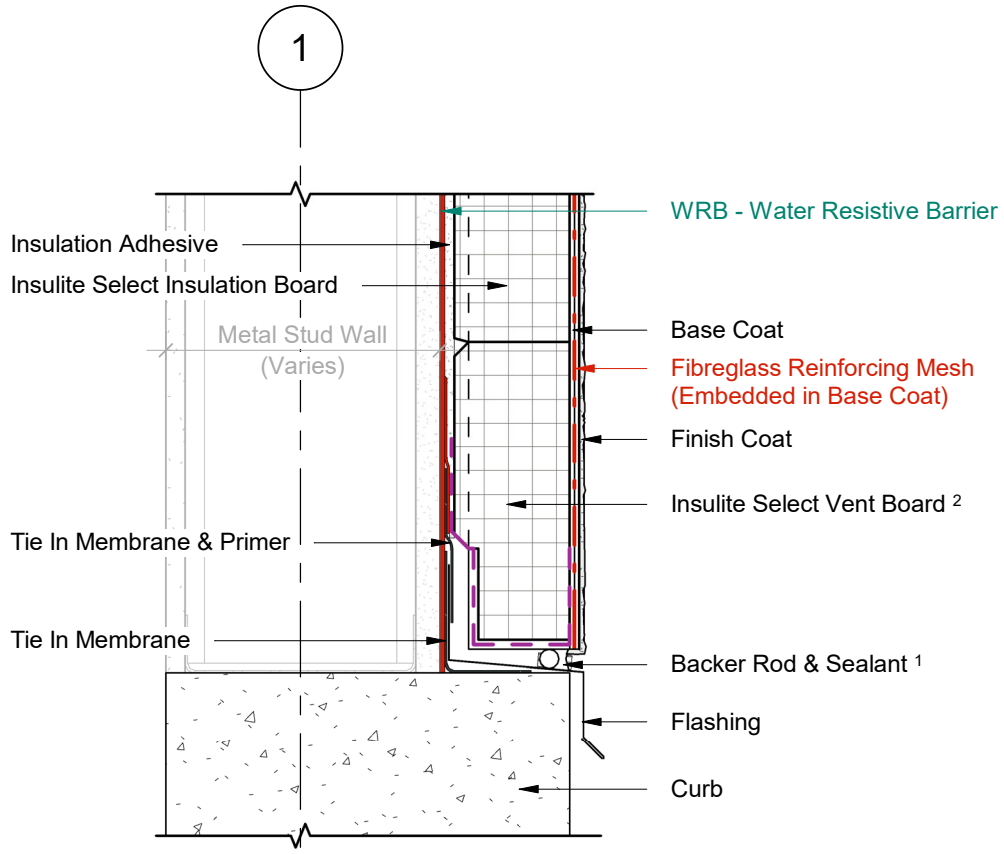

- 1 Provide venting on Backer Rod & Sealant every 48" (1200mm) O.C. minimum.
- 2 Insulite Select Vent Board includes vertical drainage channels & a 2.5" (64mm) back wrapped mesh that is adhered to the board with a Base Coat layer.

1 Wall Section
 2 Scale = 1 : 5



Durabond details are offered to assist in the development of project specific details; principles and variables incorporated in all details are the sole responsibility of the project professional(s).

**TERMINATION AT BALCONY SLAB
(OPTION A)**

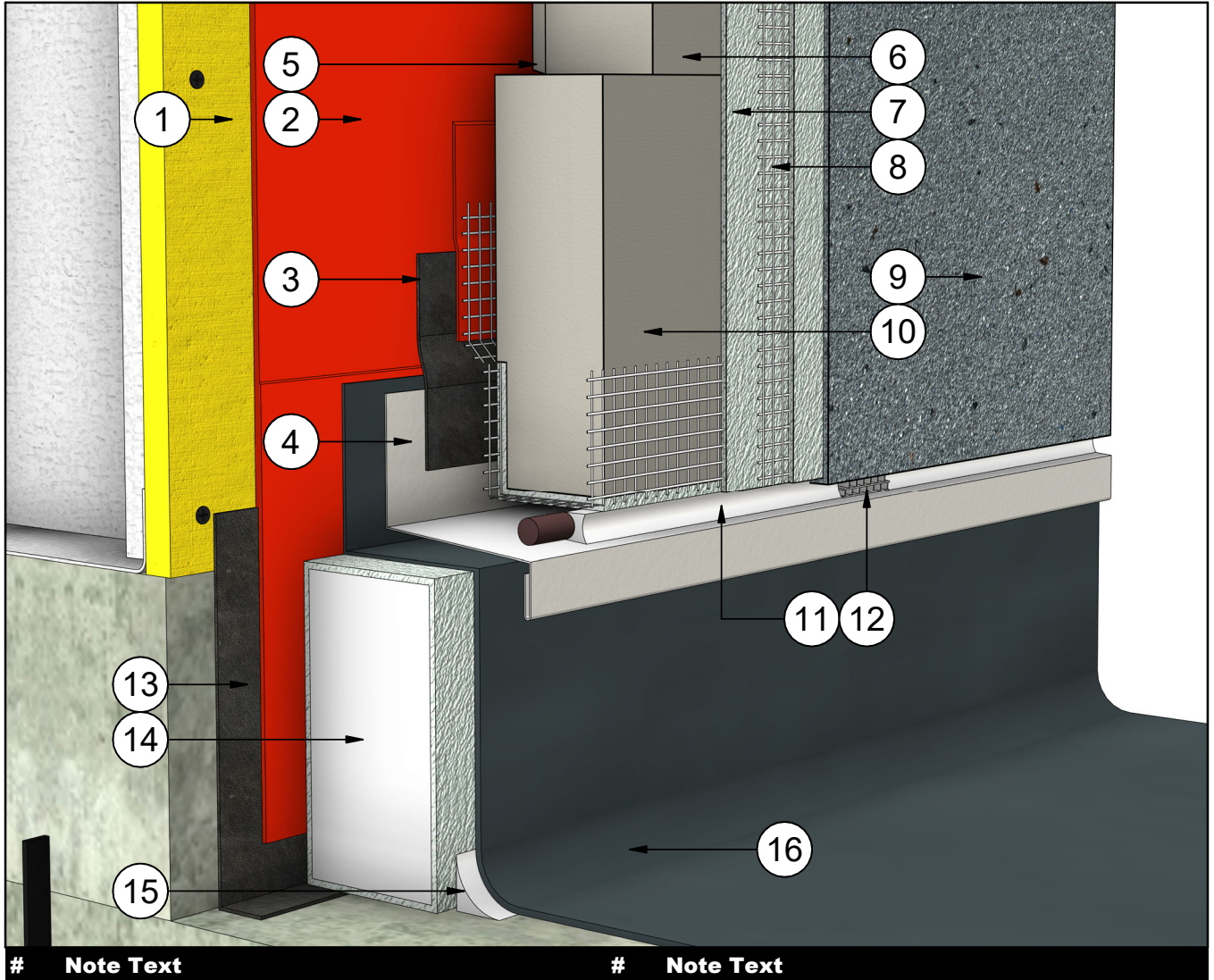

#	Note Text	#	Note Text
1	Steel Studs Frame & Sheathing	9	Finish Coat
2	WRB - Water Resistive Barrier	10	Insulite Select Vent Board
3	Tie In Membrane & Primer	11	Backer Rod & Sealant
4	Flashing	12	Sealant Vent
5	Insulation Adhesive	13	Transition Membrane
6	Insulite Select Insulation Board	14	Pre Coated Boundary Board
7	Base Coat	15	Cove Sealant
8	Fibreglass Reinforcing Mesh (Embedded in Base Coat)	16	Balcony Waterproofing

DURABOND.

Durabond details are offered to assist in the development of project specific details; principles and variables incorporated in all details are the sole responsibility of the project professional(s).

**TERMINATION AT BALCONY SLAB
(OPTION A)**

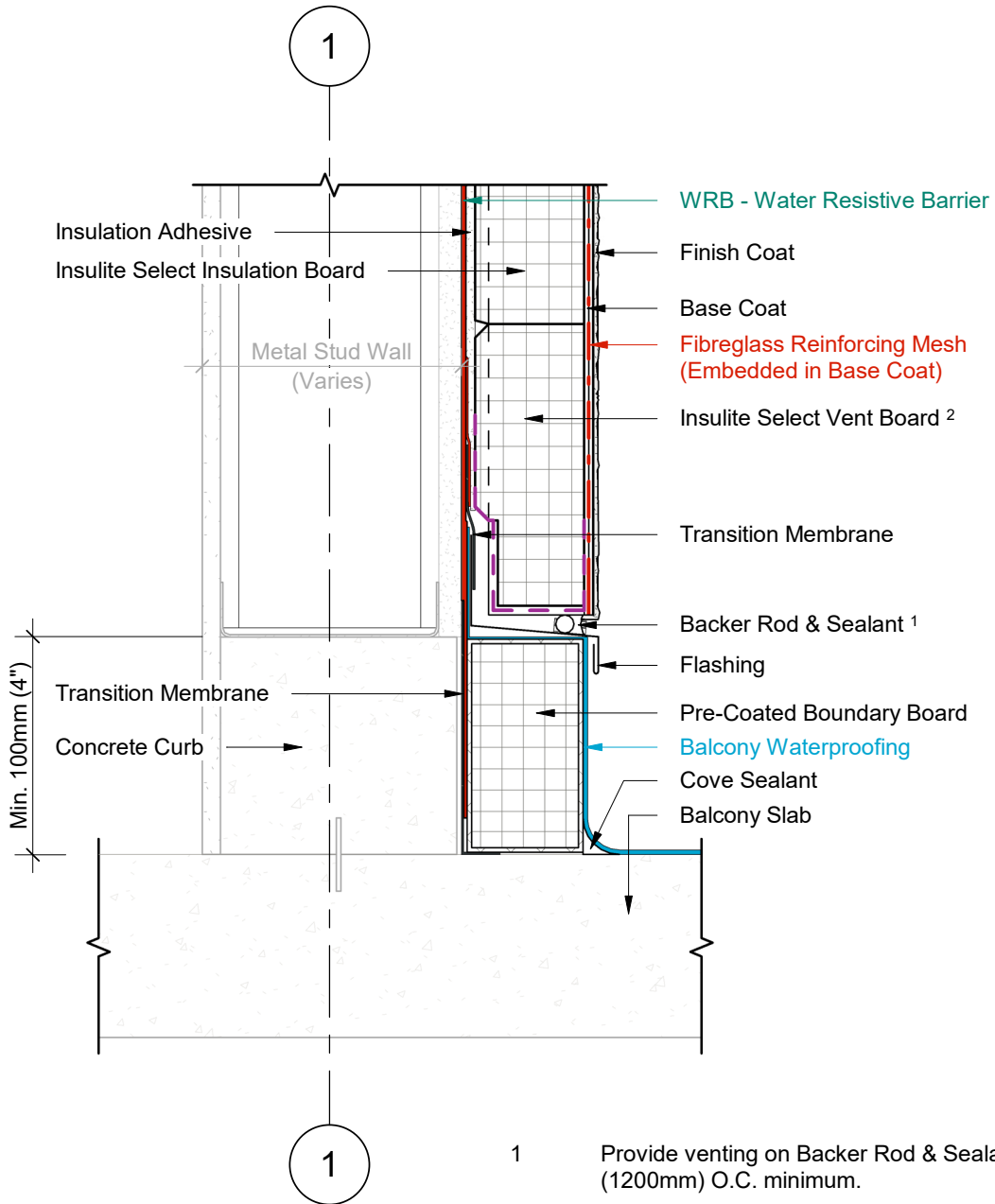

1 Wall Section
2 Scale = 1 : 5

- 1 Provide venting on Backer Rod & Sealant every 48" (1200mm) O.C. minimum.
- 2 Insulite Select Vent Board includes vertical drainage channels & a 2.5" (64mm) back wrapped mesh that is adhered to the board with a Base Coat layer.



Durabond details are offered to assist in the development of project specific details; principles and variables incorporated in all details are the sole responsibility of the project professional(s).

**TERMINATION AT BALCONY SLAB
(OPTION B)**

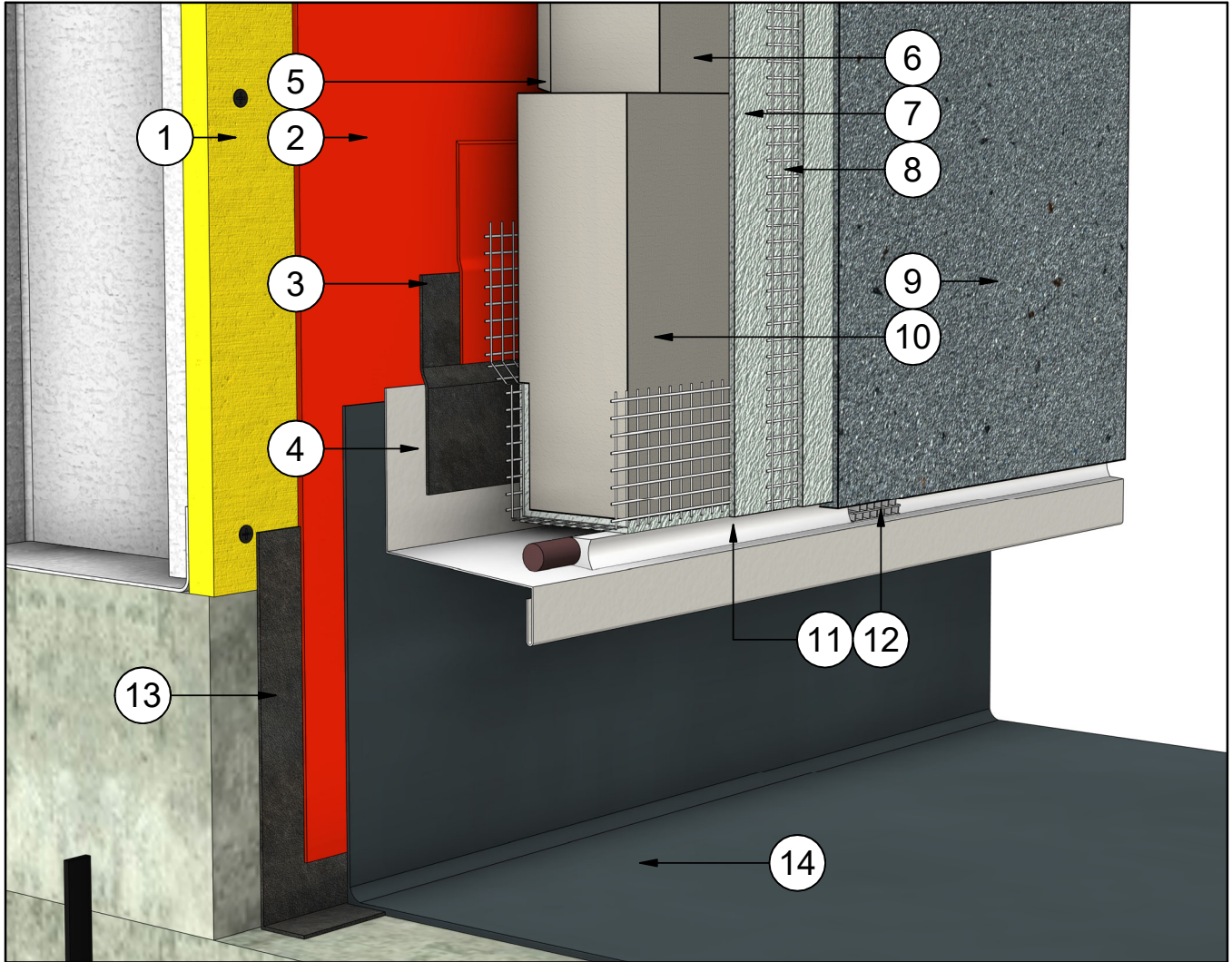

#	Note Text	#	Note Text
1	Steel Studs Frame & Sheathing	8	Fibreglass Reinforcing Mesh (Embedded in Base Coat)
2	WRB - Water Resistant Barrier	9	Finish Coat
3	Tie In Membrane & Primer	10	Insulite Select Vent Board
4	Flashing	11	Backer Rod & Sealant
5	Insulation Adhesive	12	Sealant Vent
6	Insulite Select Insulation Board	13	Transition Membrane
7	Base Coat	14	Balcony Waterproofing

DURABOND.

Durabond details are offered to assist in the development of project specific details; principles and variables incorporated in all details are the sole responsibility of the project professional(s).

**TERMINATION AT BALCONY SLAB
(OPTION B)**

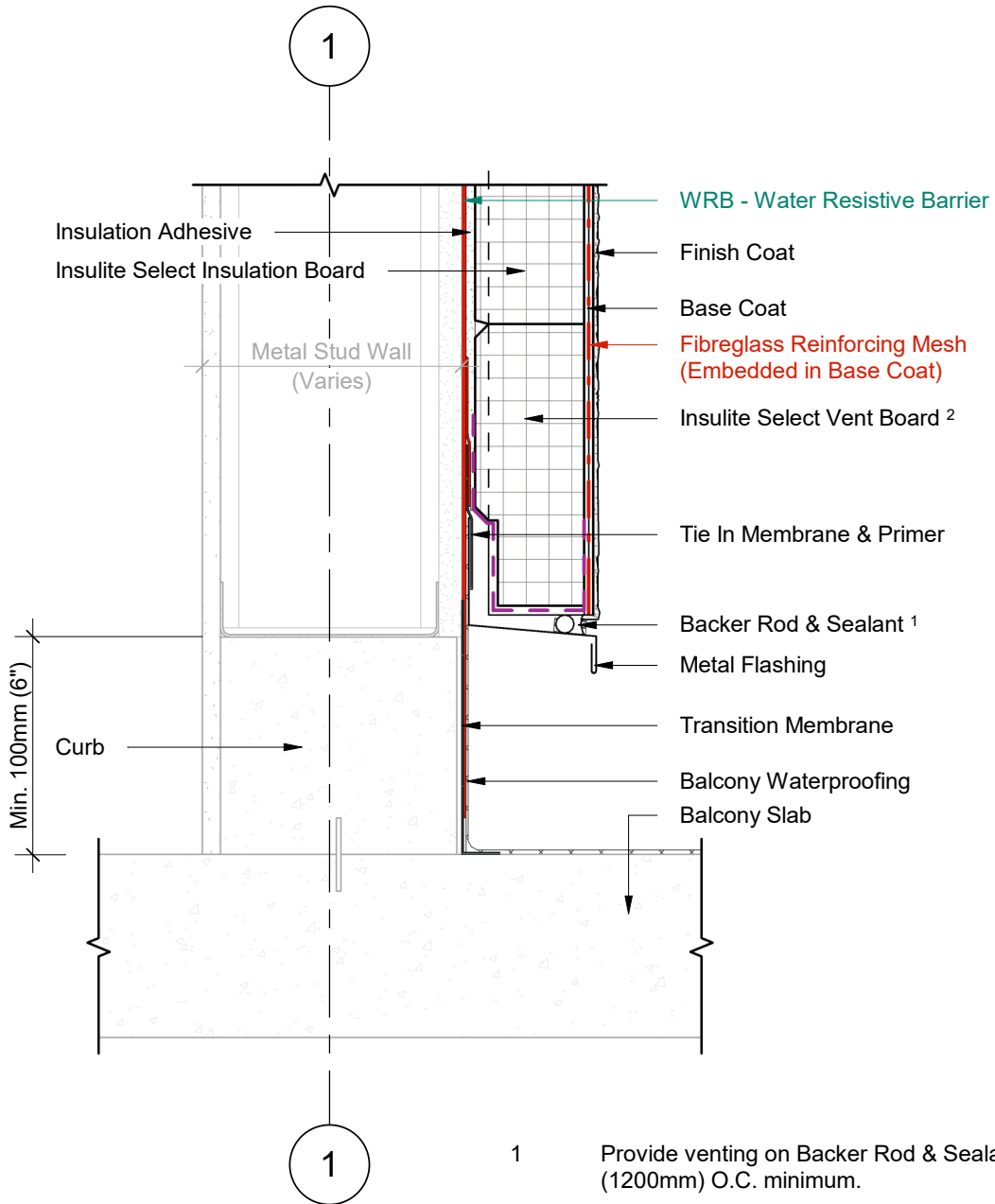

1 Wall Section
2 Scale = 1 : 5

- 1 Provide venting on Backer Rod & Sealant every 48" (1200mm) O.C. minimum.
- 2 Insulite Select Vent Board includes vertical drainage channels & a 2.5" (64mm) back wrapped mesh that is adhered to the board with a Base Coat layer.

DURABOND.

Durabond details are offered to assist in the development of project specific details; principles and variables incorporated in all details are the sole responsibility of the project professional(s).

**TERMINATION AT BALCONY SLAB
(OPTION C)**

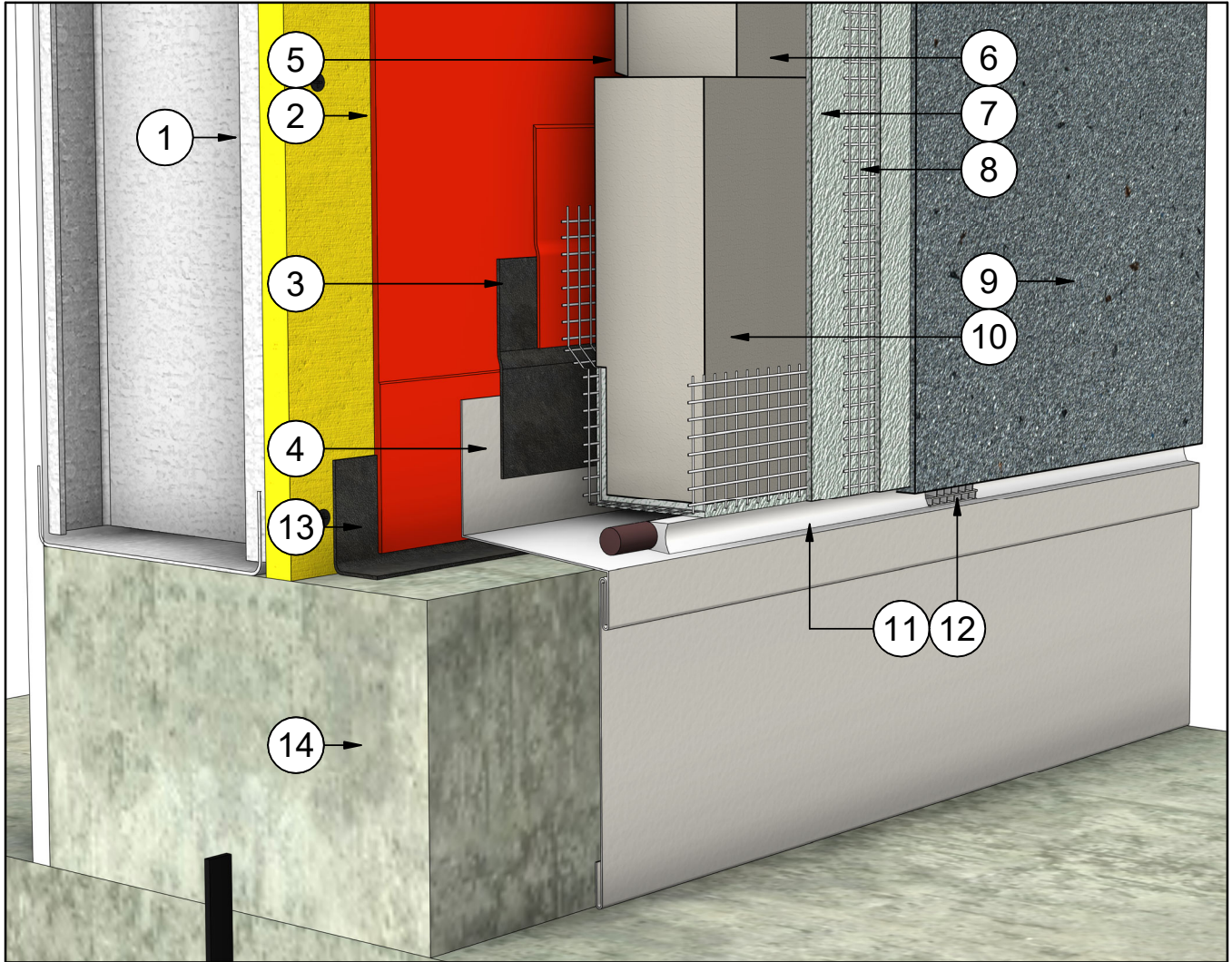

#	Note Text	#	Note Text
1	Steel Studs Frame & Sheathing	8	Fibreglass Reinforcing Mesh (Embedded in Base Coat)
2	WRB - Water Resistive Barrier	9	Finish Coat
3	Tie In Membrane & Primer	10	Insulite Select Vent Board
4	Flashing & Counterflashing	11	Backer Rod & Sealant
5	Insulation Adhesive	12	Sealant Vent
6	Insulite Select Insulation Board	13	Transition Membrane
7	Base Coat	14	Curb

DURABOND.

Durabond details are offered to assist in the development of project specific details; principles and variables incorporated in all details are the sole responsibility of the project professional(s).

**TERMINATION AT BALCONY SLAB
(OPTION C)**

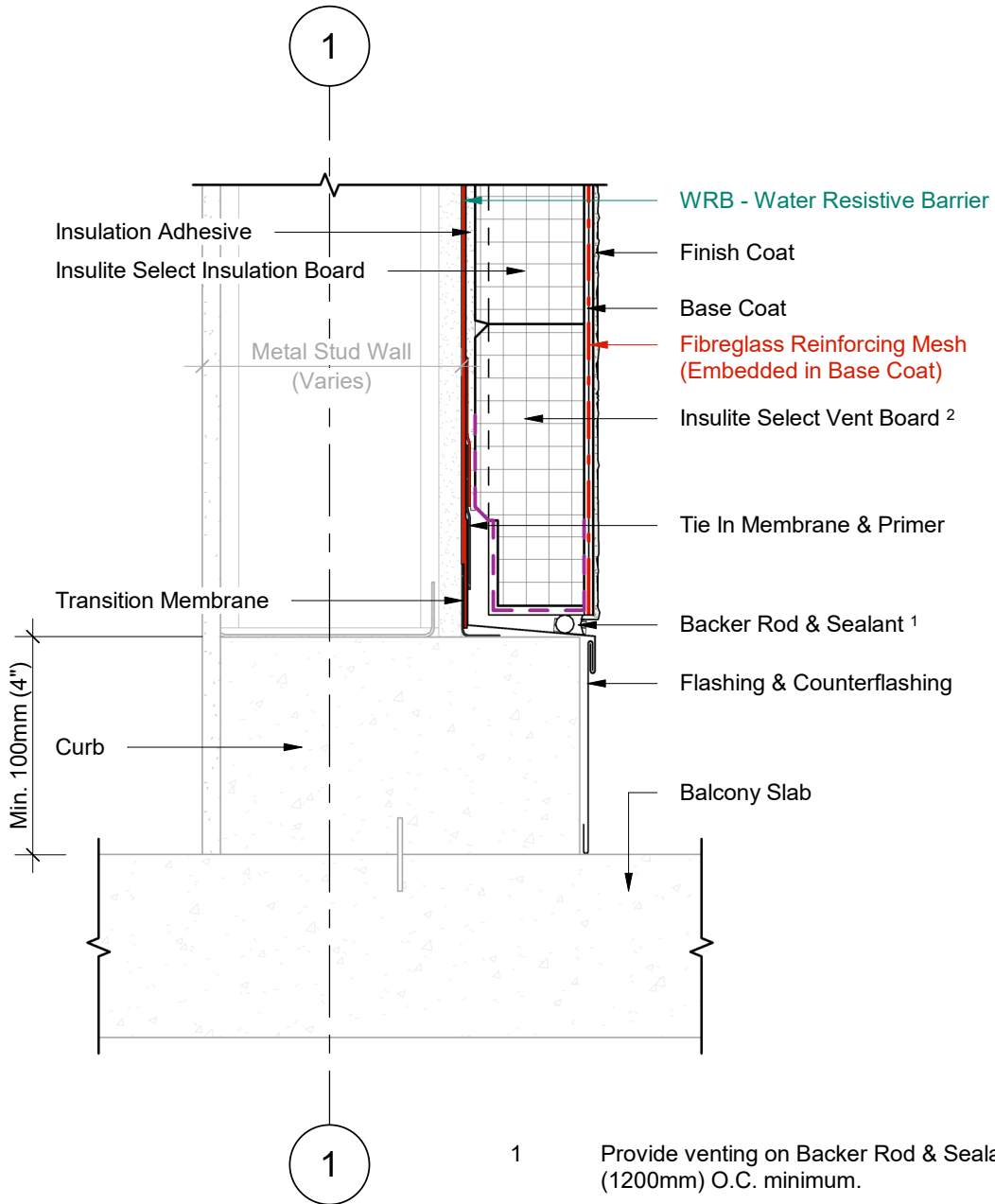

1 Wall Section
2 Scale = 1 : 5

- 1 Provide venting on Backer Rod & Sealant every 48" (1200mm) O.C. minimum.
- 2 Insulite Select Vent Board includes vertical drainage channels & a 2.5" (64mm) back wrapped mesh that is adhered to the board with a Base Coat layer.



Durabond details are offered to assist in the development of project specific details; principles and variables incorporated in all details are the sole responsibility of the project professional(s).

**TERMINATION AT BALCONY SLAB
(OPTION D)**

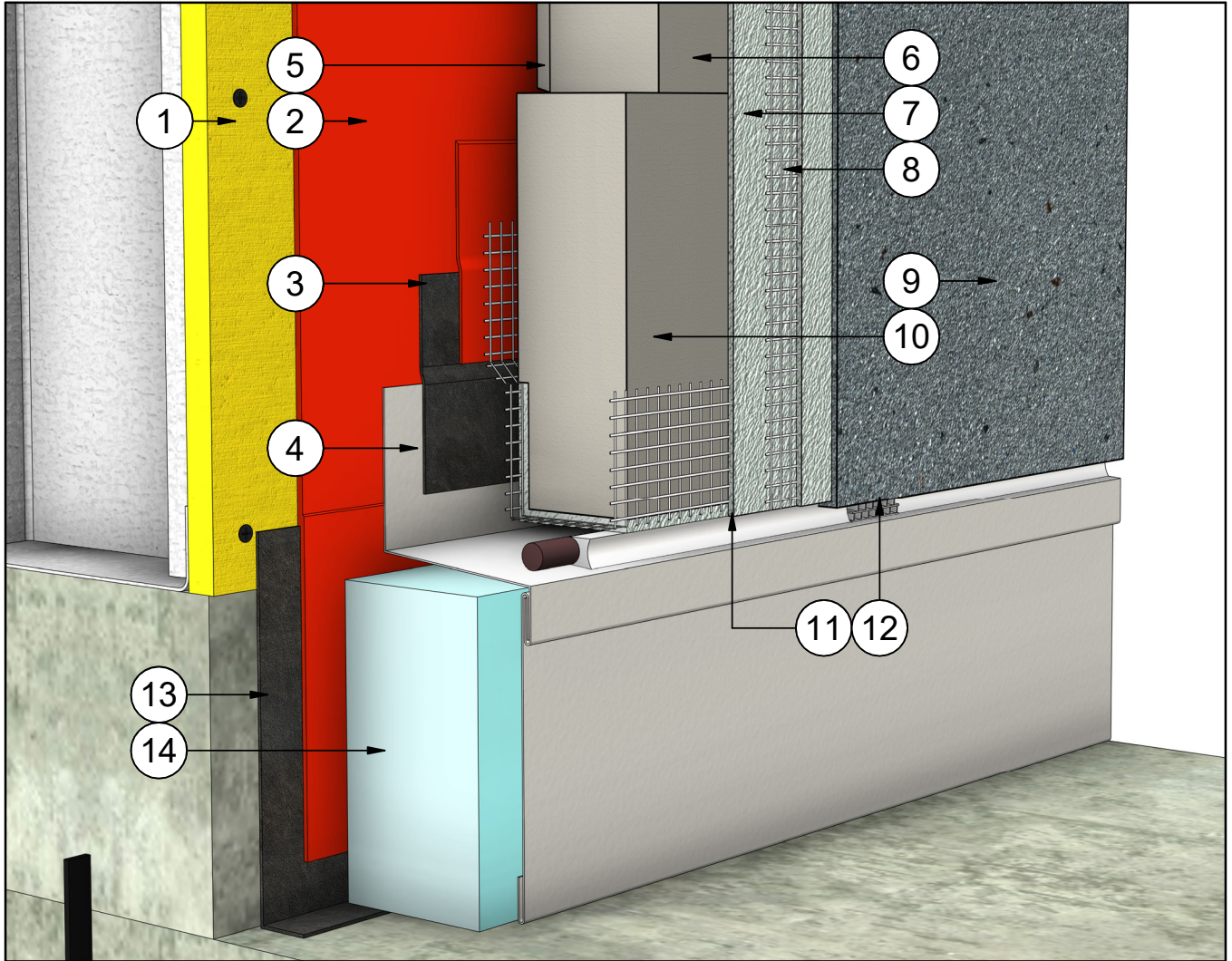

#	Note Text	#	Note Text
1	Steel Studs Frame & Sheathing	8	Fibreglass Reinforcing Mesh (Embedded in Base Coat)
2	WRB - Water Resistive Barrier	9	Finish Coat
3	Tie In Membrane & Primer	10	Insulite Select Vent Board
4	Flashing	11	Backer Rod & Sealant
5	Insulation Adhesive	12	Sealant Vent
6	Insulite Select Insulation Board	13	Transition Membrane
7	Base Coat	14	Rigid Insulation

DURABOND.

Durabond details are offered to assist in the development of project specific details; principles and variables incorporated in all details are the sole responsibility of the project professional(s).

**TERMINATION AT BALCONY SLAB
(OPTION D)**

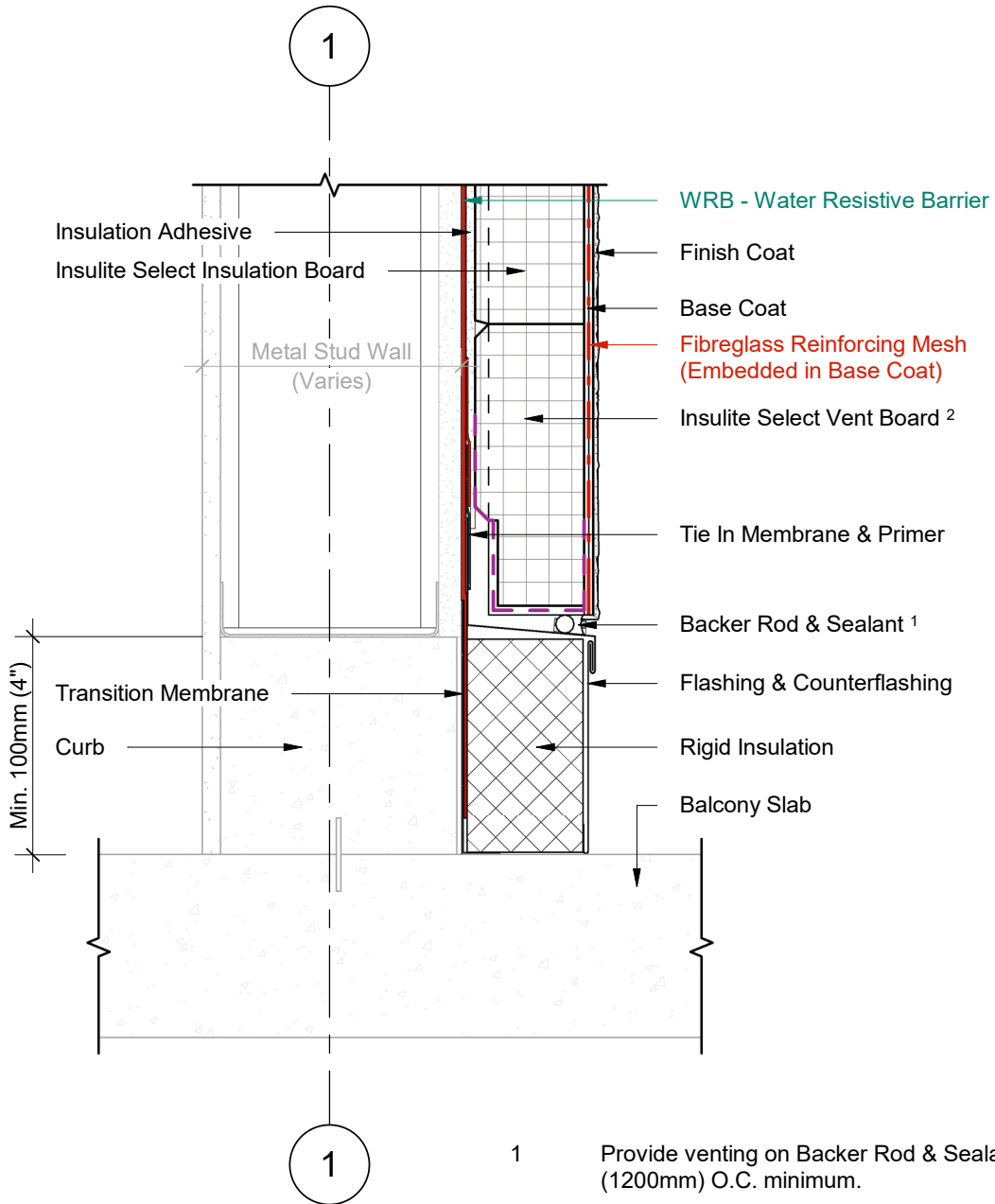

- 1 Provide venting on Backer Rod & Sealant every 48" (1200mm) O.C. minimum.
- 2 Insulite Select Vent Board includes vertical drainage channels & a 2.5" (64mm) back wrapped mesh that is adhered to the board with a Base Coat layer.

1 Wall Section
2 Scale = 1 : 5



Durabond details are offered to assist in the development of project specific details; principles and variables incorporated in all details are the sole responsibility of the project professional(s).

FOUNDATION TERMINATION WITH FLASHING

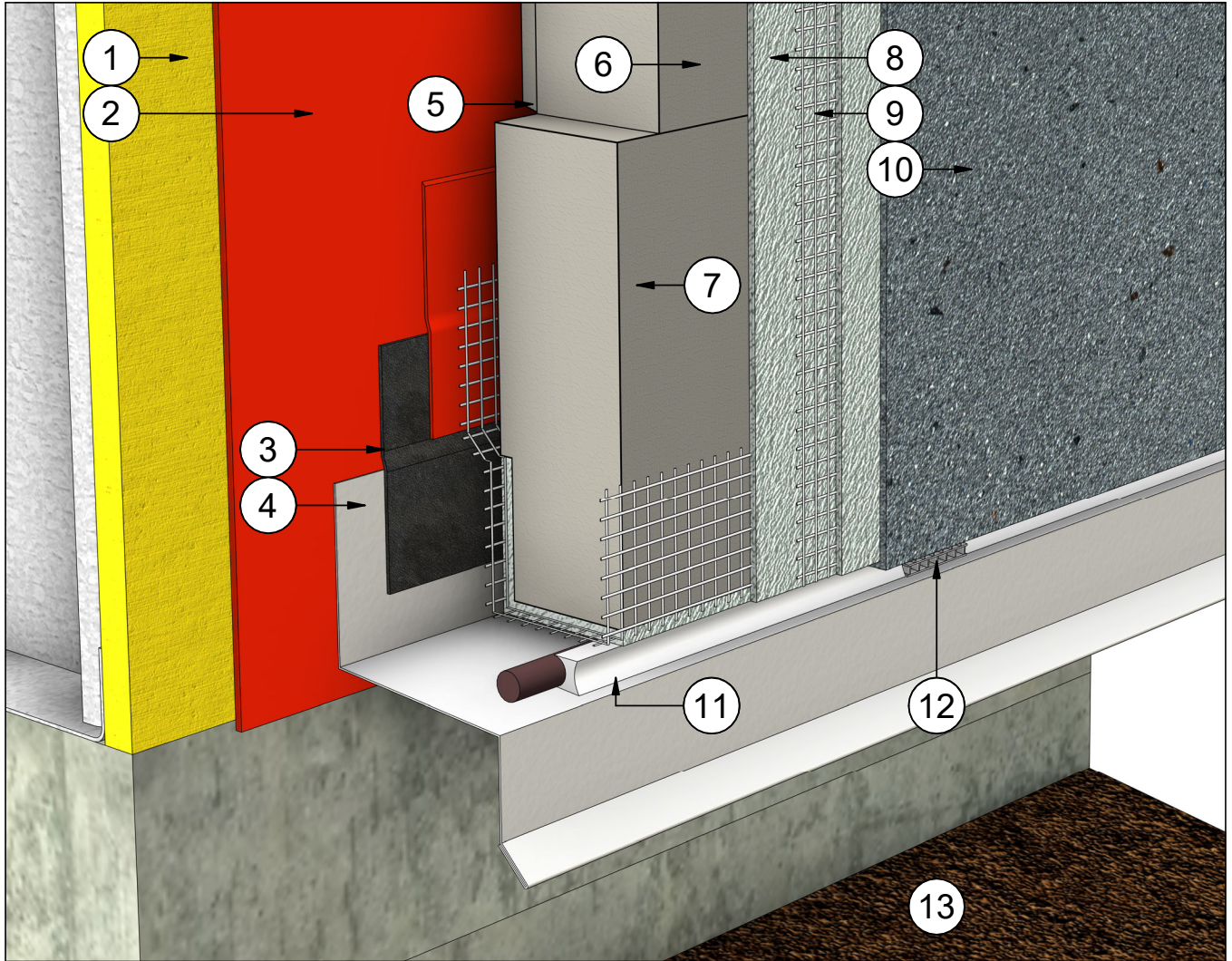

#	Note Text	#	Note Text
1	Steel Studs Frame & Sheathing	8	Base Coat
2	WRB - Water Resistive Barrier	9	Fibreglass Reinforcing Mesh (Embedded in Base Coat)
3	Tie In Membrane & Primer	10	Finish Coat
4	Flashing	11	Backer Rod & Sealant
5	Insulation Adhesive	12	Sealant Vent
6	Insulite Select Insulation Board	13	Grade
7	Insulite Select Vent Board		

DURABOND.

Durabond details are offered to assist in the development of project specific details; principles and variables incorporated in all details are the sole responsibility of the project professional(s).

FOUNDATION TERMINATION WITH FLASHING

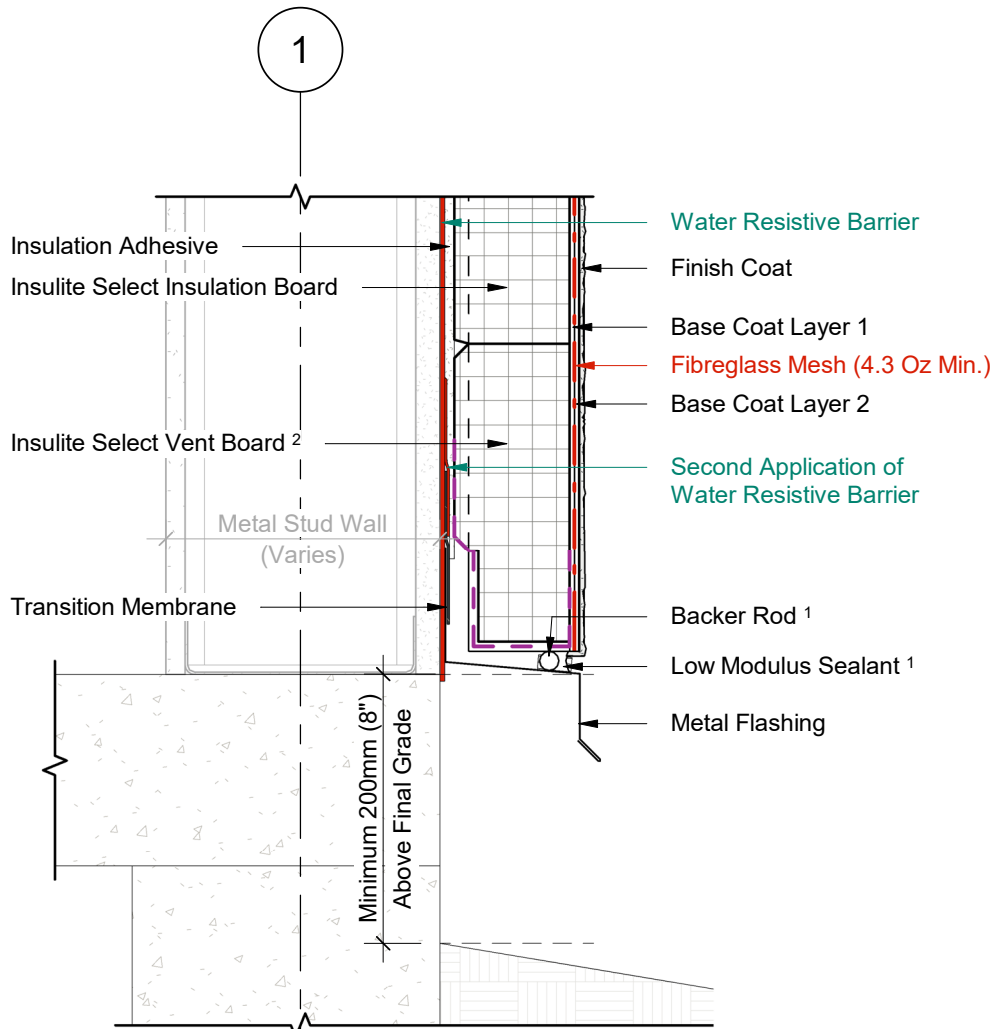

- 1 Provide venting on Backer Rod & Sealant every 48" (1200mm) O.C. minimum.
- 2 Insulite Select Vent Board includes vertical drainage channels & a 2.5" (64mm) back wrapped mesh that is adhered to the board with a Base Coat layer.

1 Wall Section
 2 Scale = 1 : 5



Durabond details are offered to assist in the development of project specific details; principles and variables incorporated in all details are the sole responsibility of the project professional(s).

INSULATED FOUNDATION WITH FLASHING

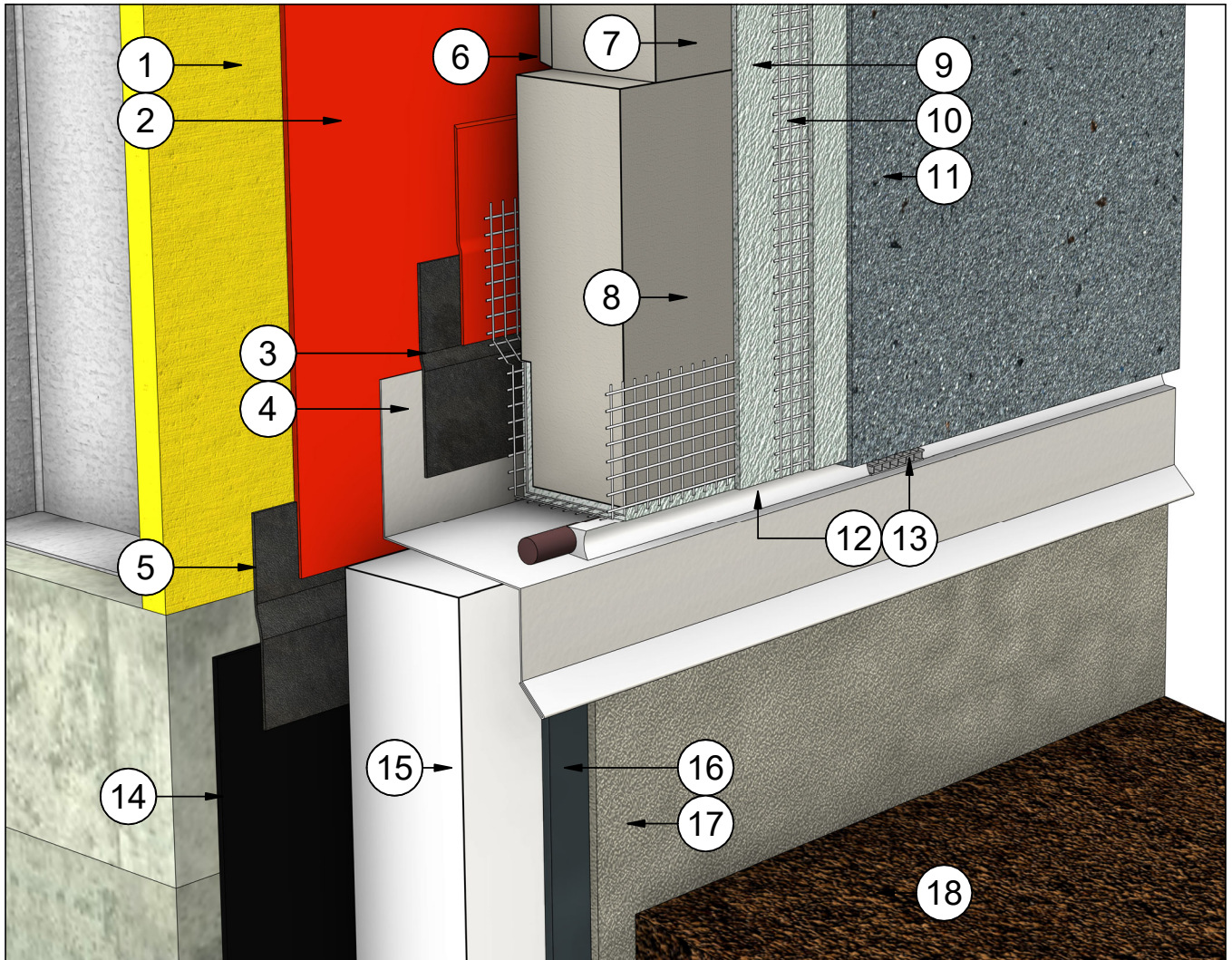

#	Note Text	#	Note Text
1	Steel Studs Frame & Sheathing	10	Fibreglass Reinforcing Mesh (Embedded in Base Coat)
2	WRB - Water Resistant Barrier	11	Finish Coat
3	Tie In Membrane & Primer	12	Backer Rod & Sealant
4	Flashing	13	Sealant Vent
5	Tie In Membrane	14	Air/Vapour Barrier
6	Insulation Adhesive	15	Below Grade EPS Insulation
7	Insulite Select Insulation Board	16	Elastomeric Waterproofing
8	Insulite Select Vent Board	17	Latex Modified Cement
9	Base Coat	18	Grade

DURABOND.

Durabond details are offered to assist in the development of project specific details; principles and variables incorporated in all details are the sole responsibility of the project professional(s).

INSULATED FOUNDATION WITH FLASHING

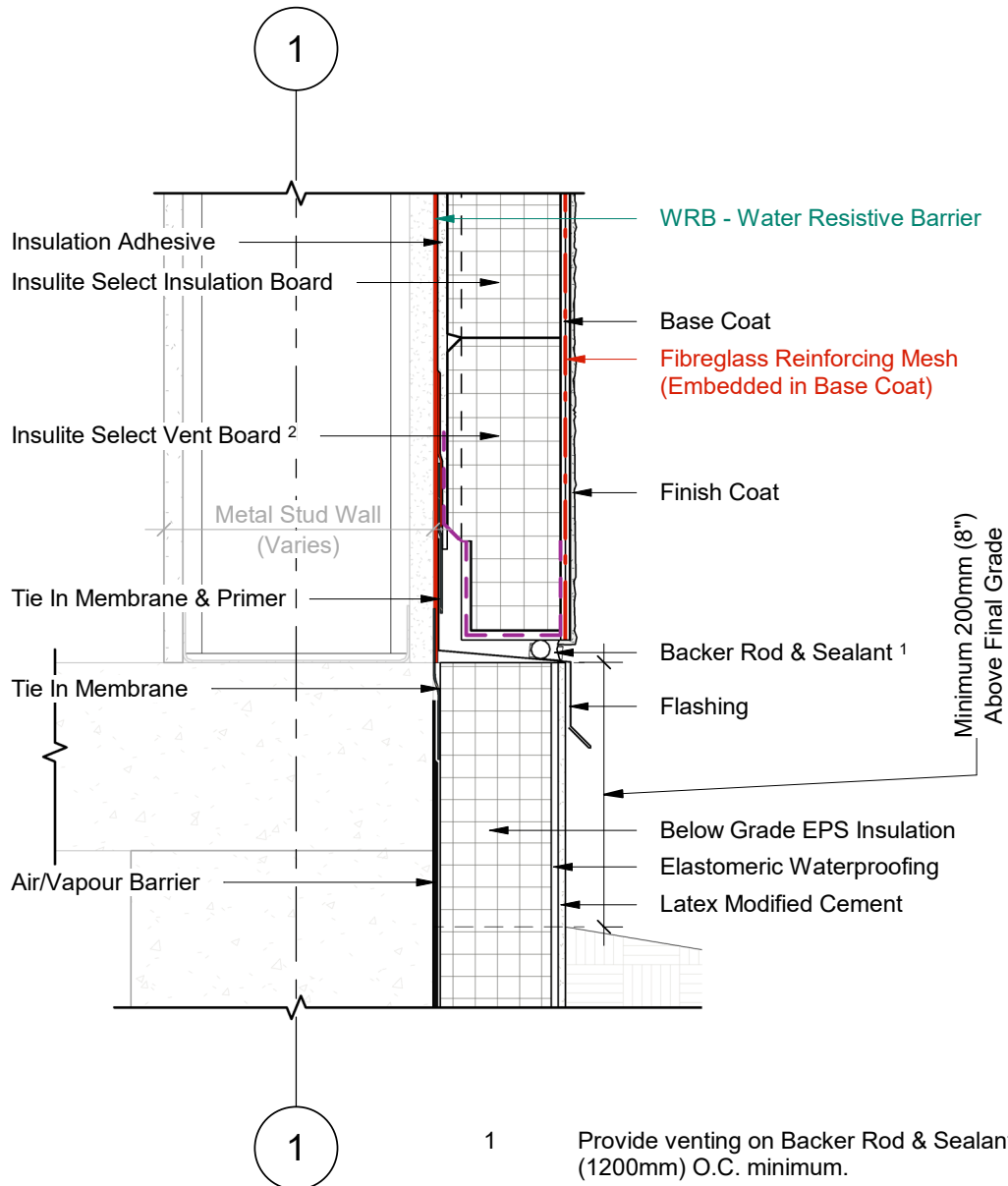

1 Wall Section
2 Scale = 1 : 5

- 1 Provide venting on Backer Rod & Sealant every 48" (1200mm) O.C. minimum.
- 2 Insulite Select Vent Board includes vertical drainage channels & a 2.5" (64mm) back wrapped mesh that is adhered to the board with a Base Coat layer.

DURABOND.

Durabond details are offered to assist in the development of project specific details; principles and variables incorporated in all details are the sole responsibility of the project professional(s).

VERTICAL CLADDING CHANGE

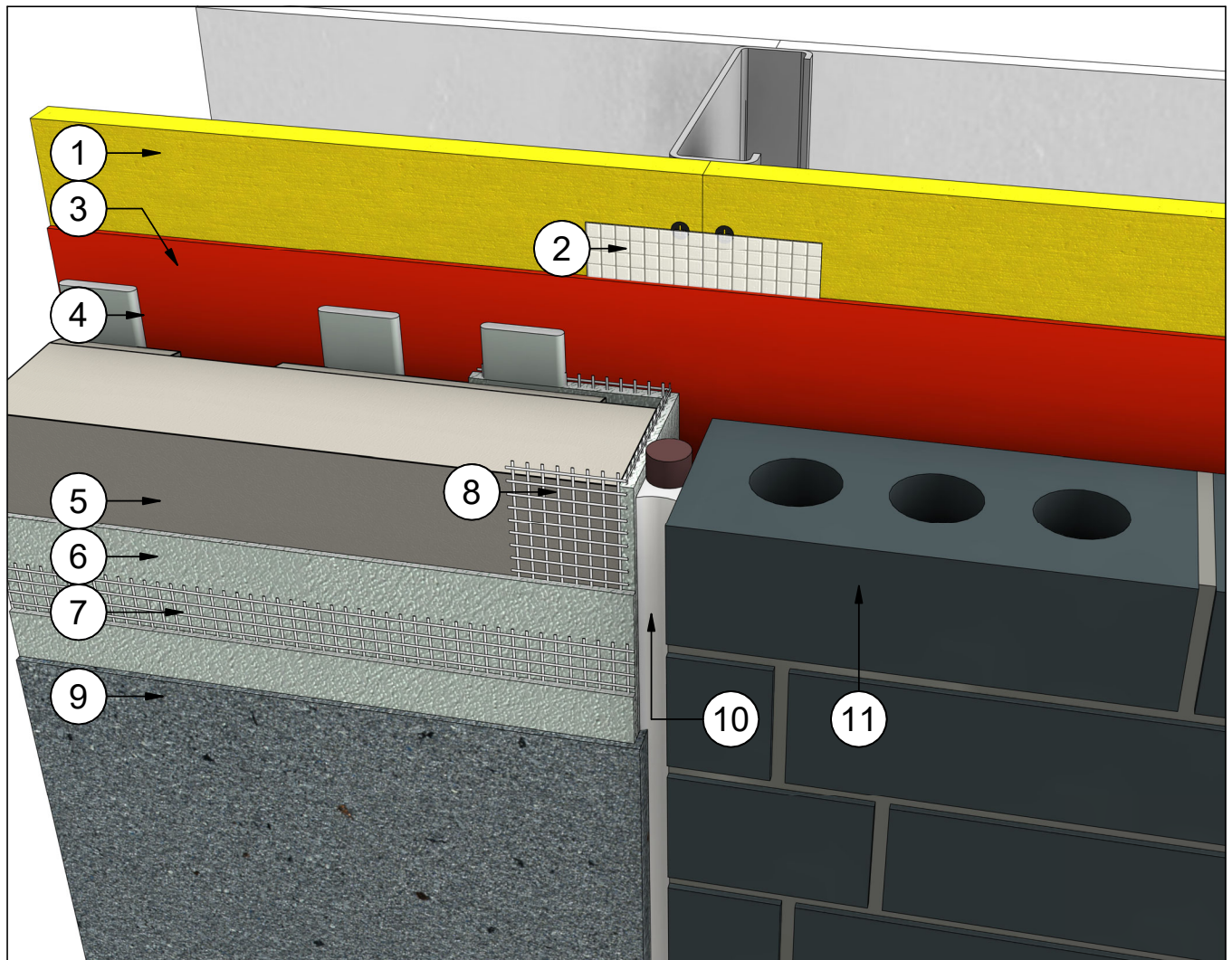

Note Text

- 1 Steel Studs Frame & Sheathing
- 2 Barrier Seam Tape (Embedded in WRB)
- 3 WRB - Water Resistive Barrier
- 4 Insulation Adhesive
- 5 Insulite Select Insulation Board / Boundary Board
- 6 Base Coat
- 7 Fibreglass Reinforcing Mesh (Embedded in Base Coat)
- 8 Fibreglass Reinforcing Mesh (Embedded in Base Coat)
- 9 Finish Coat
- 10 Backer Rod & Sealant
- 11 Alternate Cladding



Durabond details are offered to assist in the development of project specific details; principles and variables incorporated in all details are the sole responsibility of the project professional(s).

VERTICAL CLADDING CHANGE

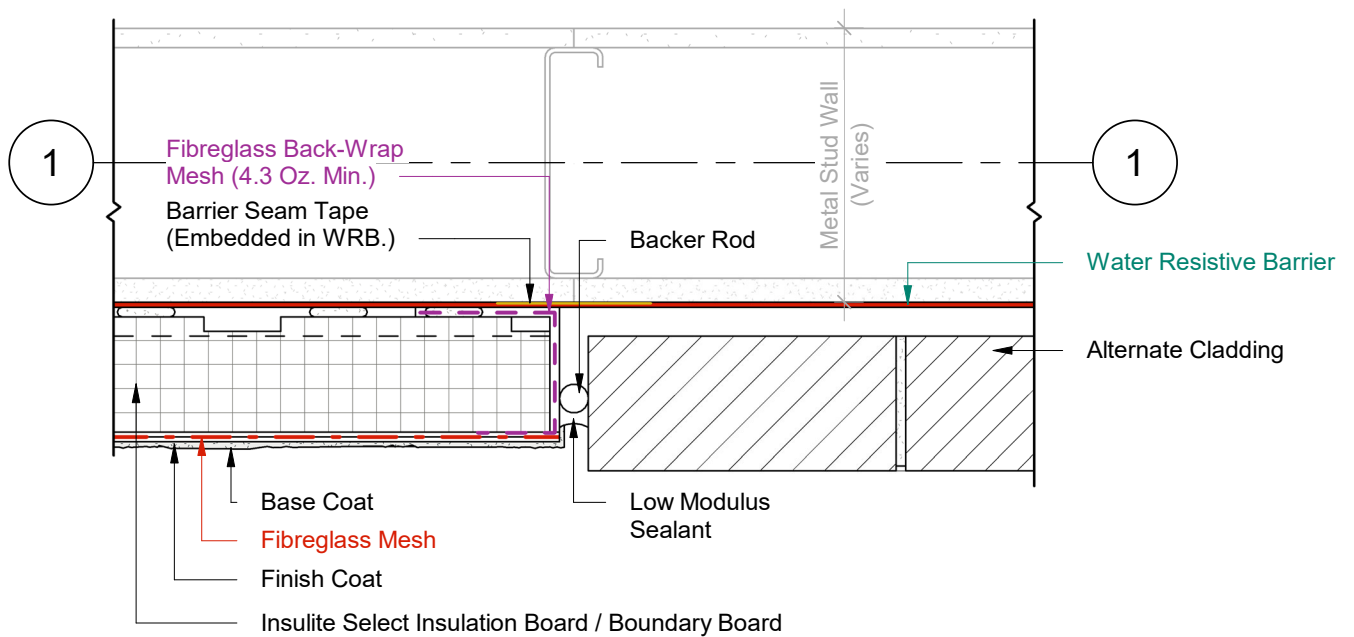

- 1 Plan Detail
- 2 Scale = 1:5



Durabond details are offered to assist in the development of project specific details; principles and variables incorporated in all details are the sole responsibility of the project professional(s).

WINDOW HEAD (OPTION A)

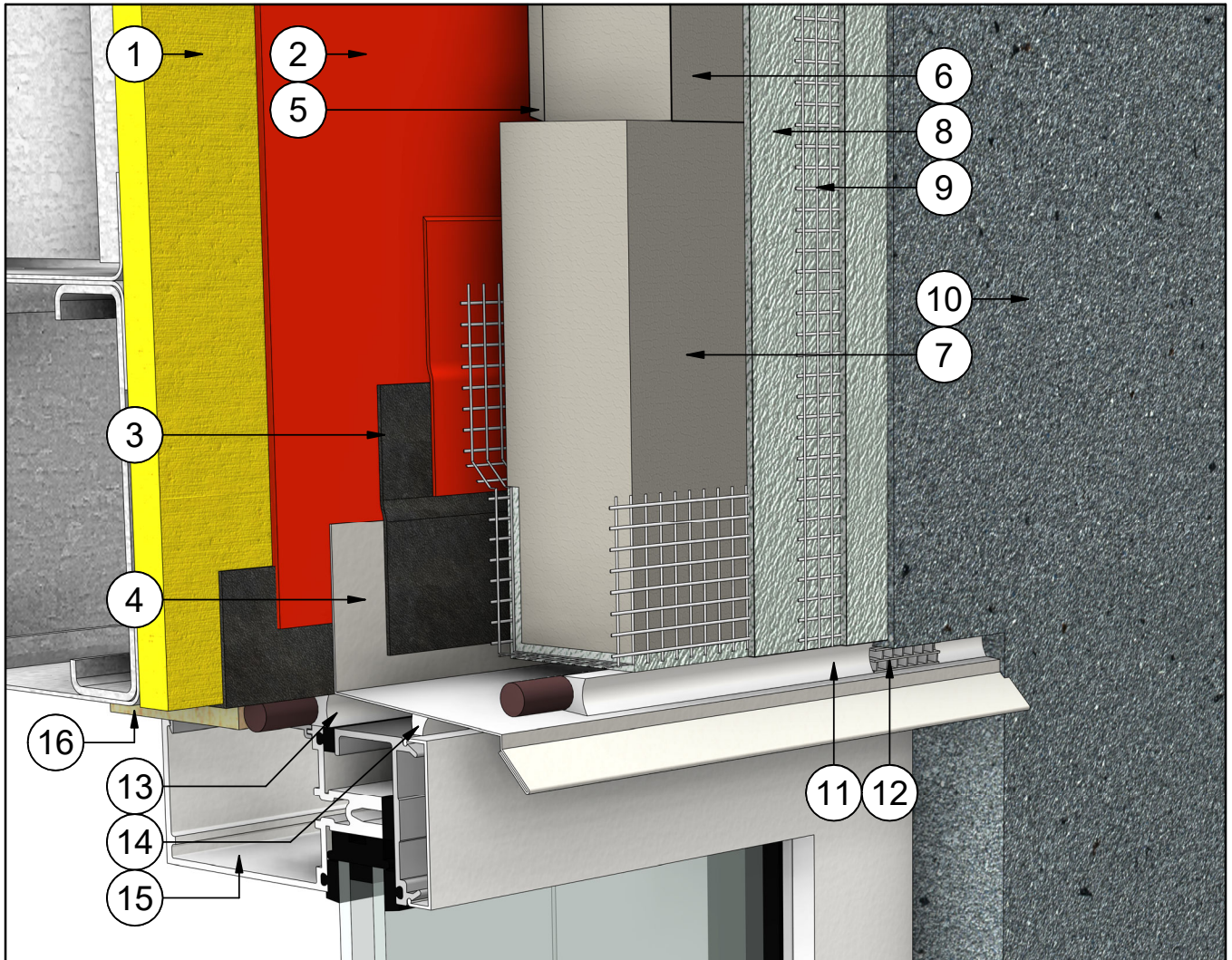

#	Note Text	#	Note Text
1	Steel Studs Frame & Sheathing	7	Insulite Select Vent Board
2	WRB - Water Resistant Barrier	10	Finish Coat
3	Tie In Membrane & Primer	11	Backer Rod & Sealant
4	Flashing w/ End Dams	12	Sealant Vent
5	Insulation Adhesive	13	Backer Rod & Sealant
6	Insulite Select Insulation Board	14	Sealant
8	Base Coat	15	Window Assembly
9	Fiberglass Reinforcing Mesh (Embedded in Base Coat)	16	Wood Blocking

DURABOND.

Durabond details are offered to assist in the development of project specific details; principles and variables incorporated in all details are the sole responsibility of the project professional(s).

WINDOW HEAD (OPTION A)

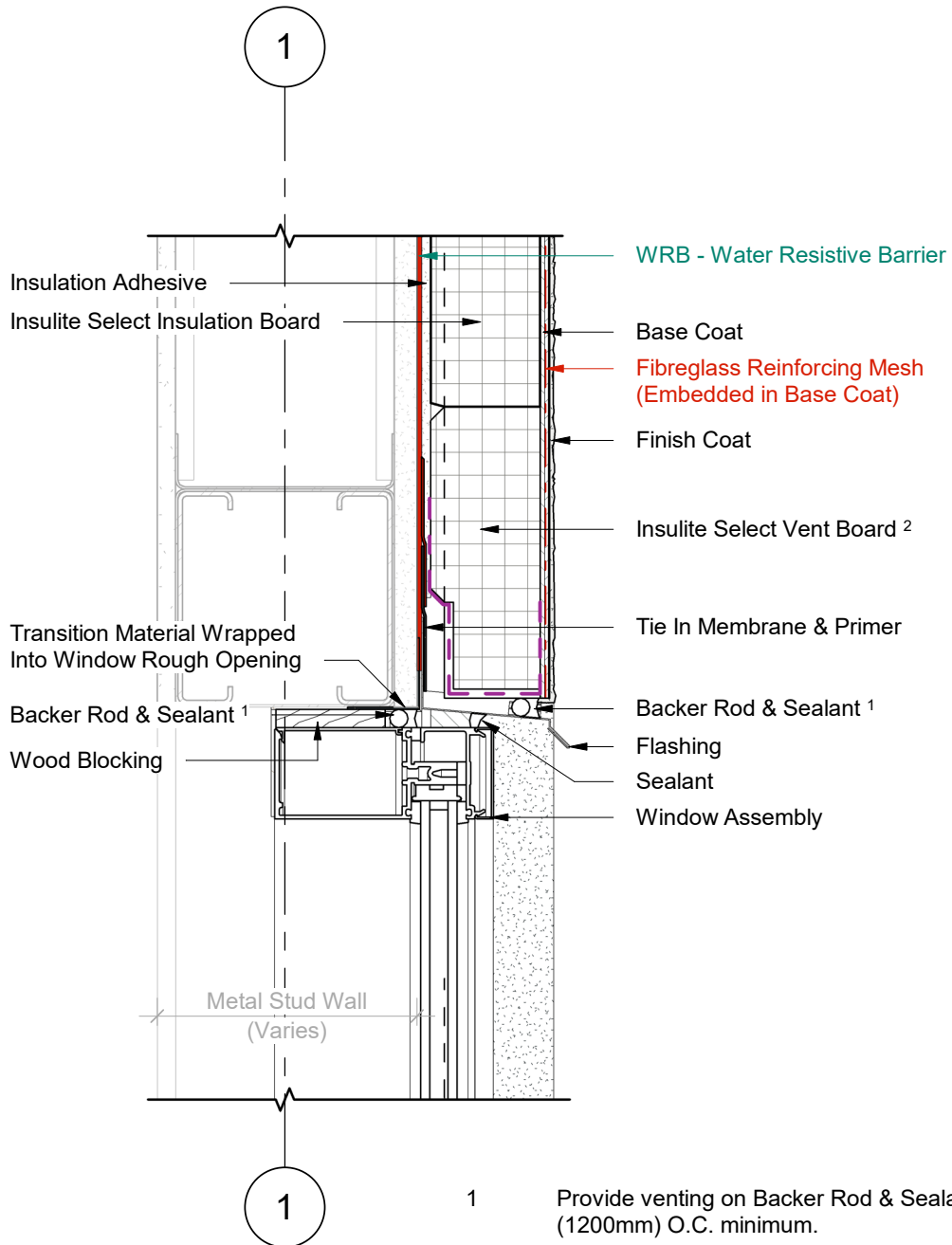

1 Wall Section
2 Scale = 1 : 5

- 1 Provide venting on Backer Rod & Sealant every 48" (1200mm) O.C. minimum.
- 2 Insulite Select Vent Board includes vertical drainage channels & a 2.5" (64mm) back wrapped mesh that is adhered to the board with a Base Coat layer.

DURABOND.

Durabond details are offered to assist in the development of project specific details; principles and variables incorporated in all details are the sole responsibility of the project professional(s).

WINDOW HEAD (OPTION A)

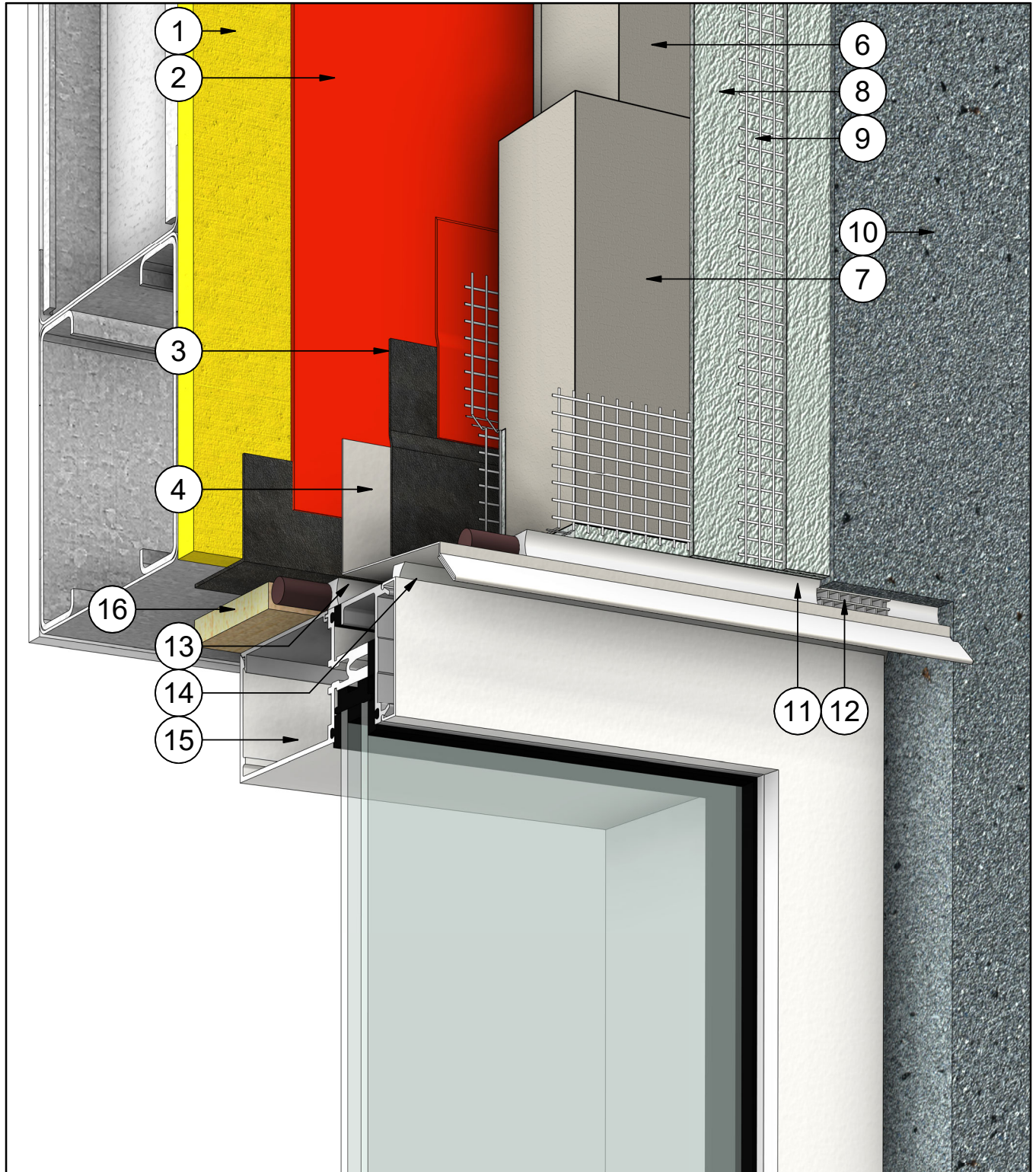

DURabond.

Durabond details are offered to assist in the development of project specific details; principles and variables incorporated in all details are the sole responsibility of the project professional(s).

WINDOW SILL (OPTION A)

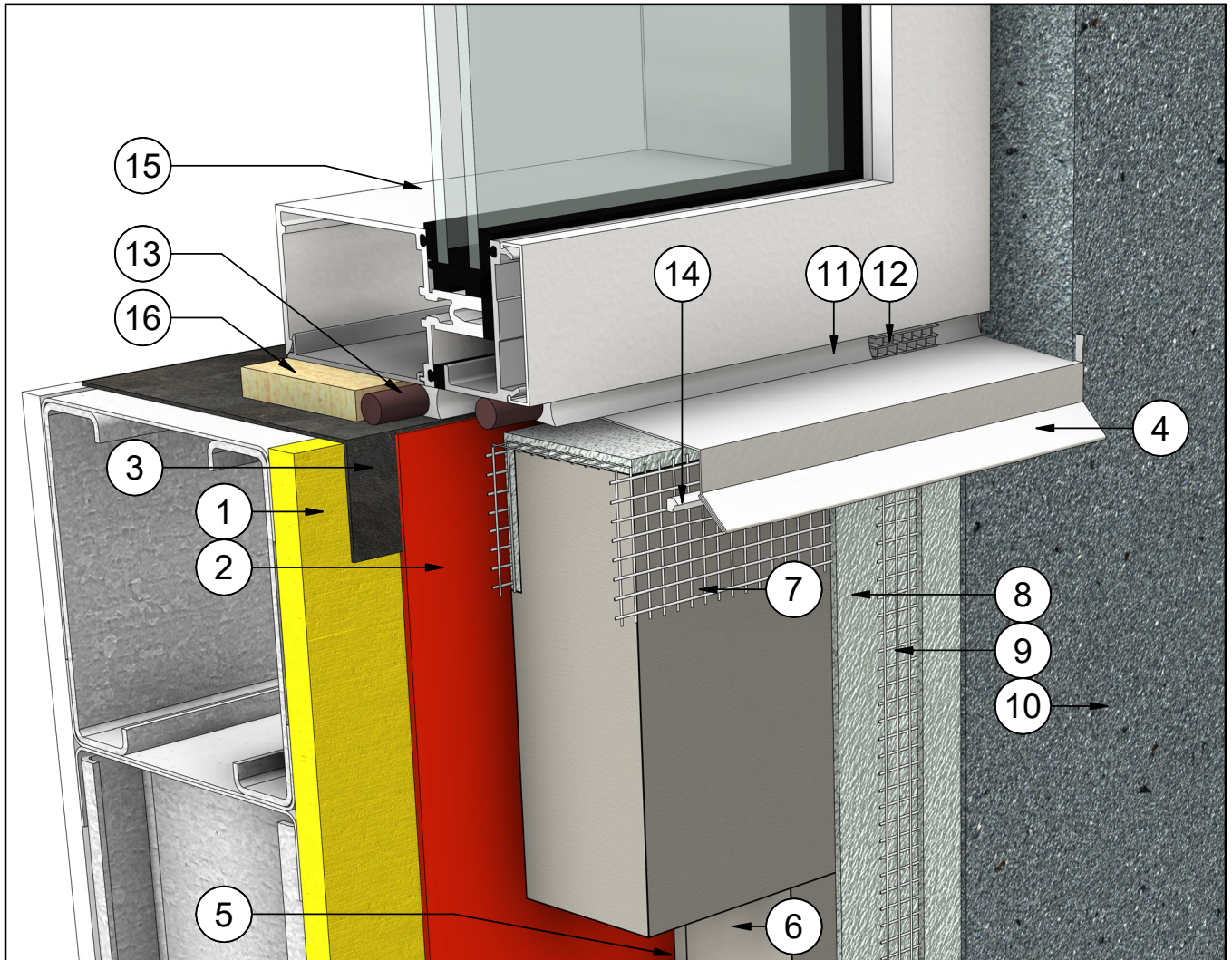

#	Note Text	#	Note Text
1	Steel Studs Frame & Sheathing	10	Finish Coat
2	WRB - Water Resistant Barrier	11	Backer Rod & Sealant
3	Transition Membrane	12	Sealant Vent
4	Flashing w/ End Dams	13	Backer Rod & Sealant
5	Insulation Adhesive	14	Sealant
6	Insulite Select Insulation Board	15	Window Assembly
7	Insulite Select Vent Board	16	Wood Blocking
8	Base Coat		
9	Fiberglass Reinforcing Mesh (Embedded in Base Coat)		

DURABOND.

Durabond details are offered to assist in the development of project specific details; principles and variables incorporated in all details are the sole responsibility of the project professional(s).

WINDOW SILL (OPTION A)

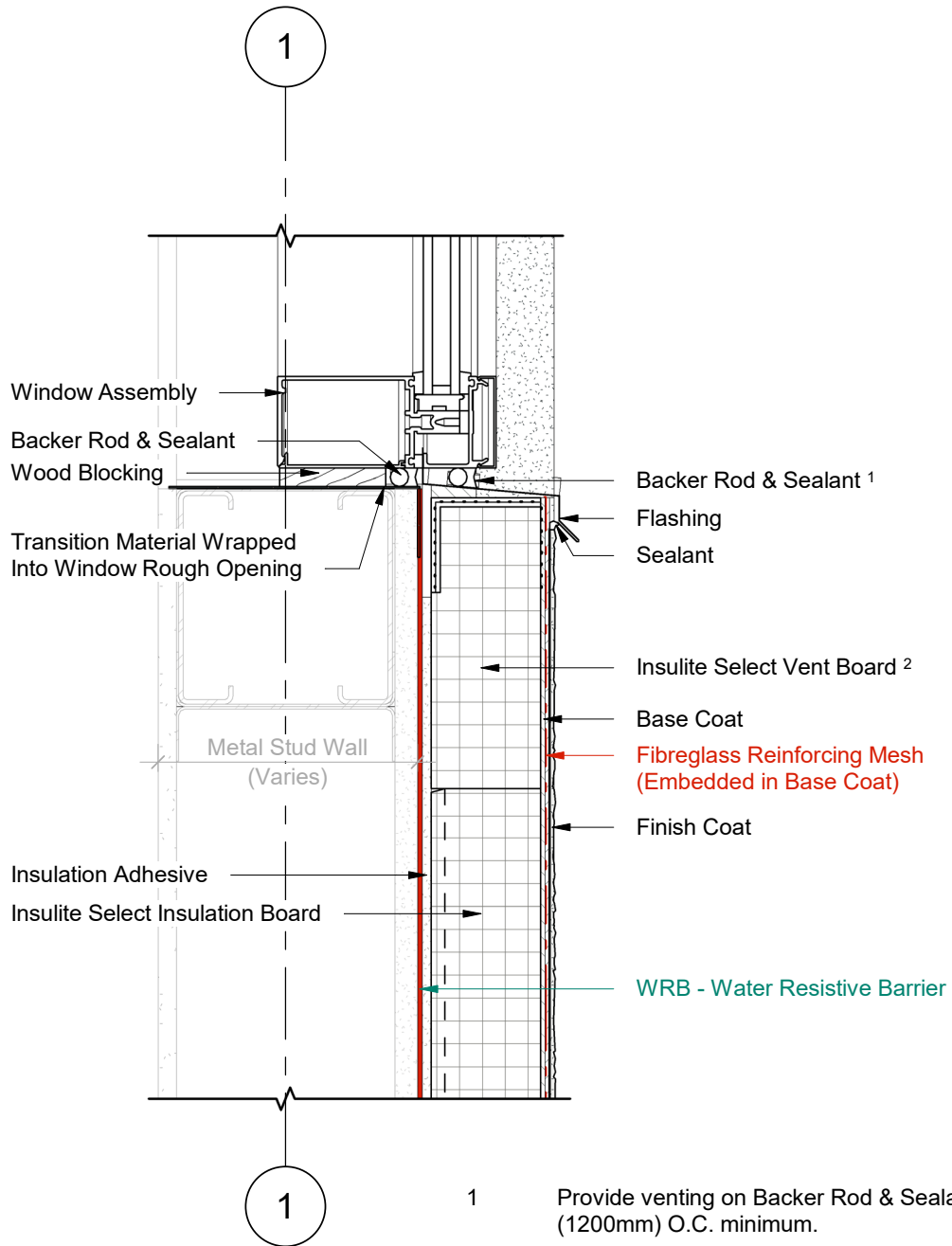

1 Wall Section
 2 Scale = 1 : 5

- 1 Provide venting on Backer Rod & Sealant every 48" (1200mm) O.C. minimum.
- 2 Insulite Select Vent Board includes vertical drainage channels & a 2.5" (64mm) back wrapped mesh that is adhered to the board with a Base Coat layer.



Durabond details are offered to assist in the development of project specific details; principles and variables incorporated in all details are the sole responsibility of the project professional(s).

WINDOW SILL (OPTION A)

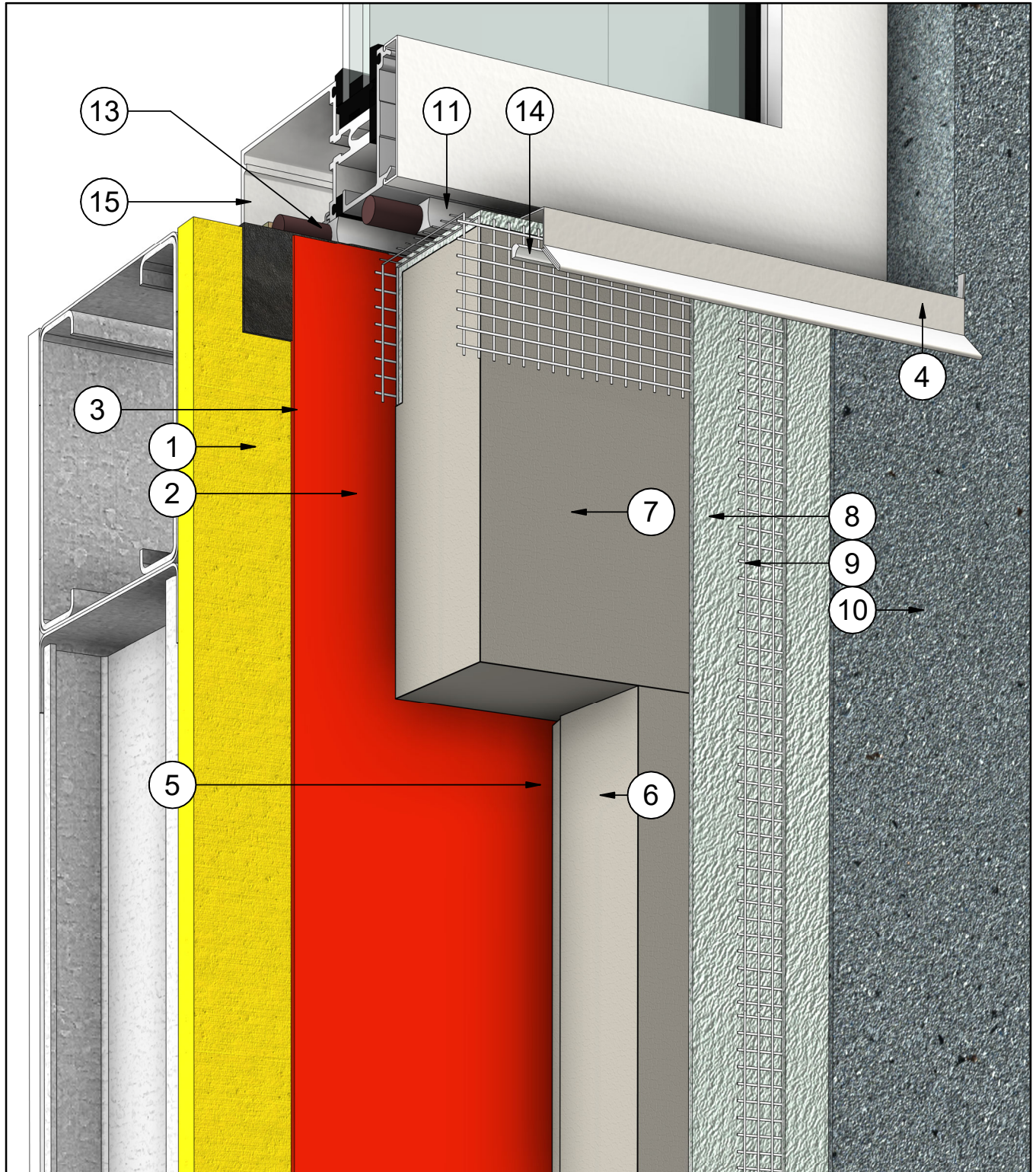

DURabond.

Durabond details are offered to assist in the development of project specific details; principles and variables incorporated in all details are the sole responsibility of the project professional(s).

WINDOW JAMB (OPTION A)

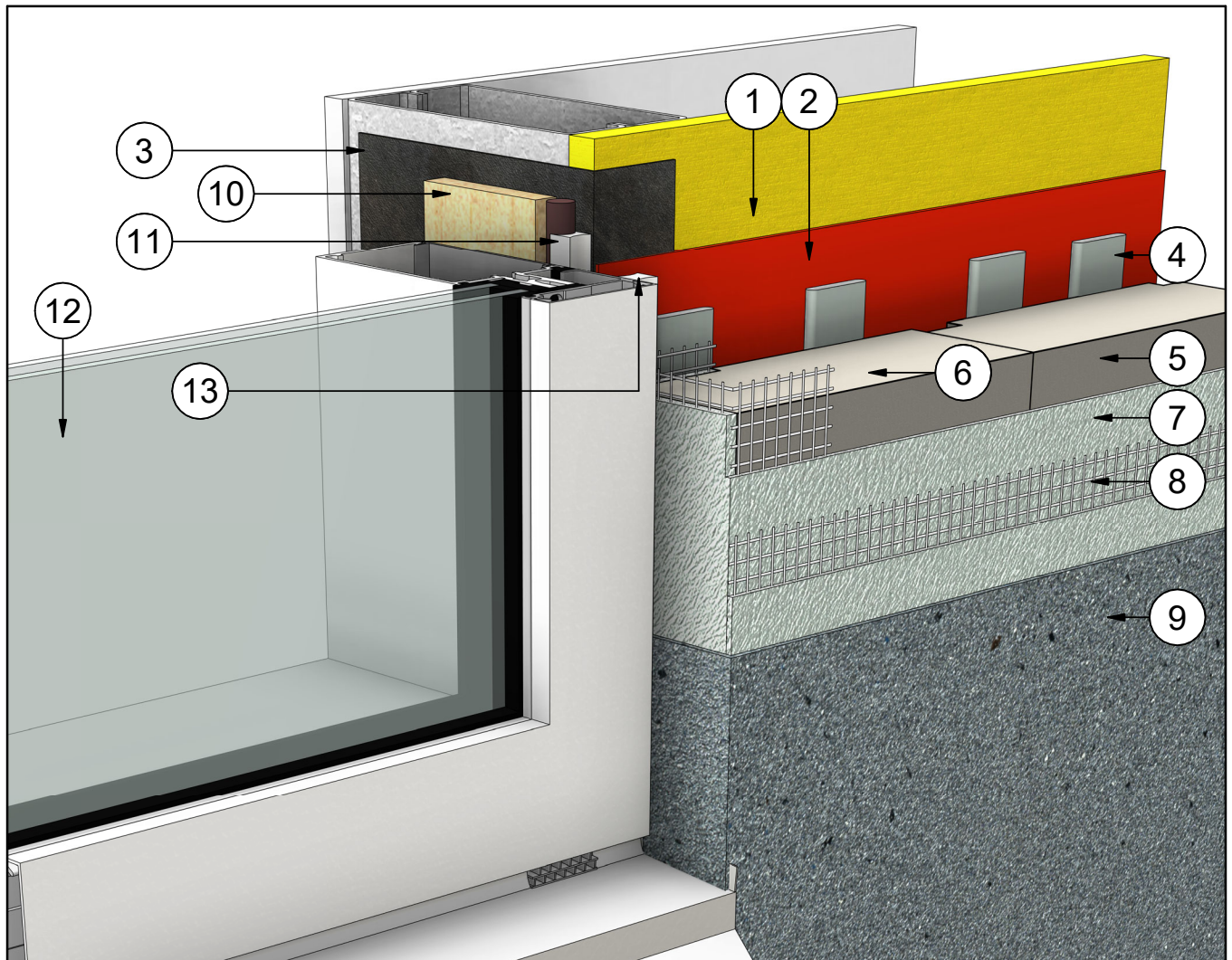

#	Note Text	#	Note Text
1	Steel Studs Frame & Sheathing	9	Finish Coat
2	WRB - Water Resistant Barrier	10	Wood Blocking
3	Transition Membrane	11	Backer Rod & Sealant
4	Insulation Adhesive	12	Window Assembly
5	Insulite Select Insulation Board	13	Sealant
6	Insulite Select Boundary Board		
7	Base Coat		
8	Fibreglass Reinforcing Mesh (Embedded in Base Coat)		

DURABOND.

Durabond details are offered to assist in the development of project specific details; principles and variables incorporated in all details are the sole responsibility of the project professional(s).

WINDOW JAMB (OPTION A)

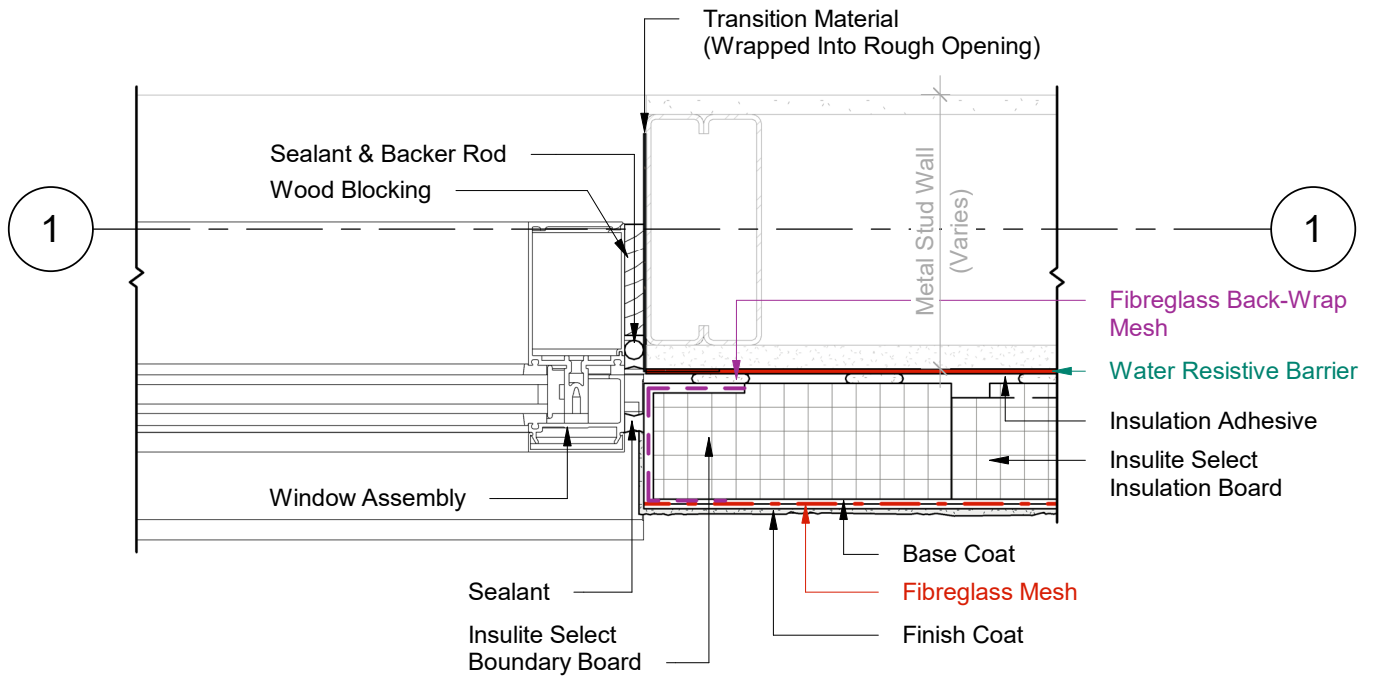

1 Plan Detail
2 Scale = 1:5

- 1 Provide venting on Backer Rod & Sealant every 48" (1200mm) O.C. minimum.
- 2 Insulite Select Vent Board includes vertical drainage channels & a 2.5" (64mm) back wrapped mesh that is adhered to the board with a Base Coat layer.



Durabond details are offered to assist in the development of project specific details; principles and variables incorporated in all details are the sole responsibility of the project professional(s).

WINDOW JAMB (OPTION A)

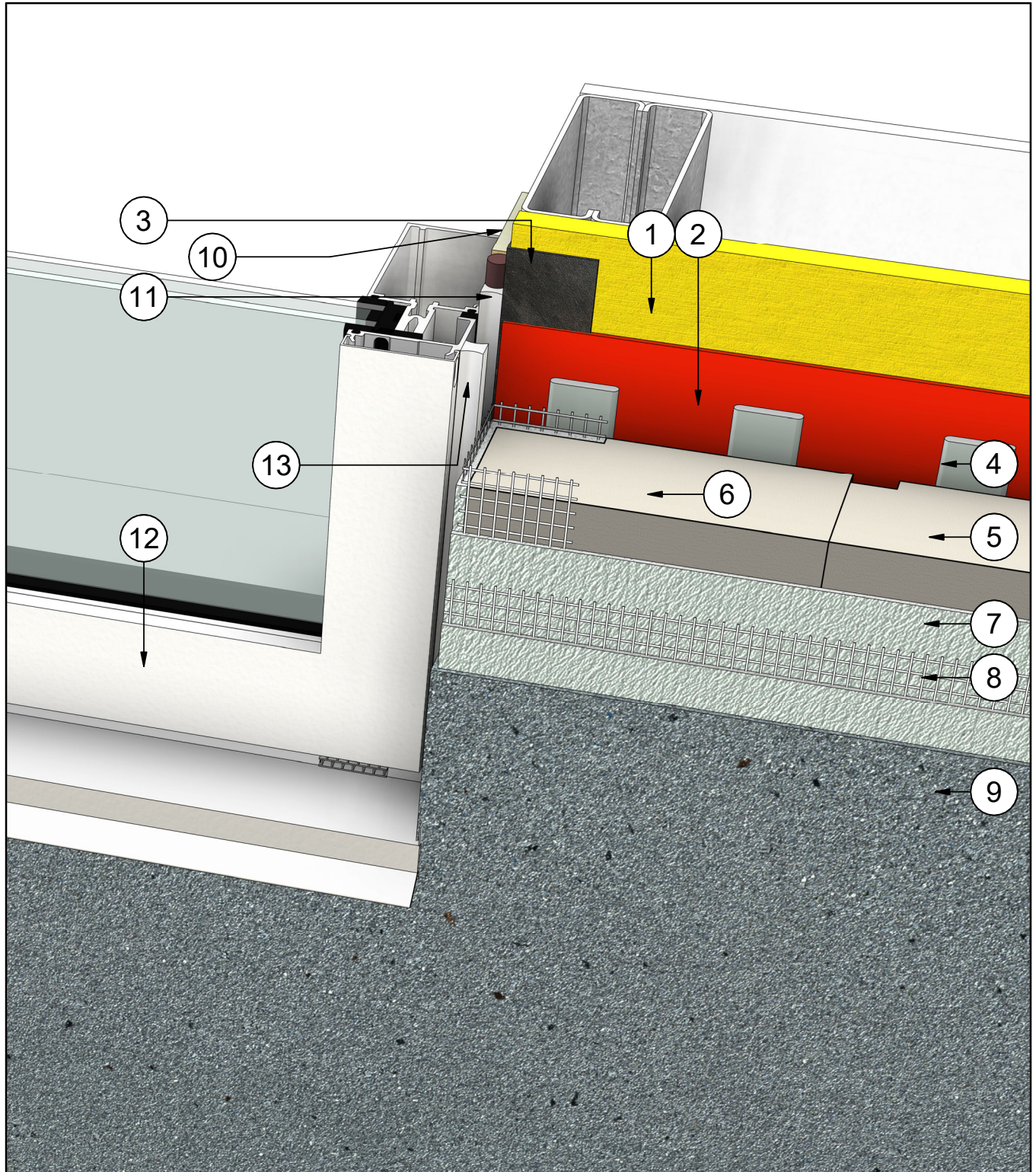

DURabond.

Durabond details are offered to assist in the development of project specific details; principles and variables incorporated in all details are the sole responsibility of the project professional(s).

WINDOW HEAD (OPTION B)

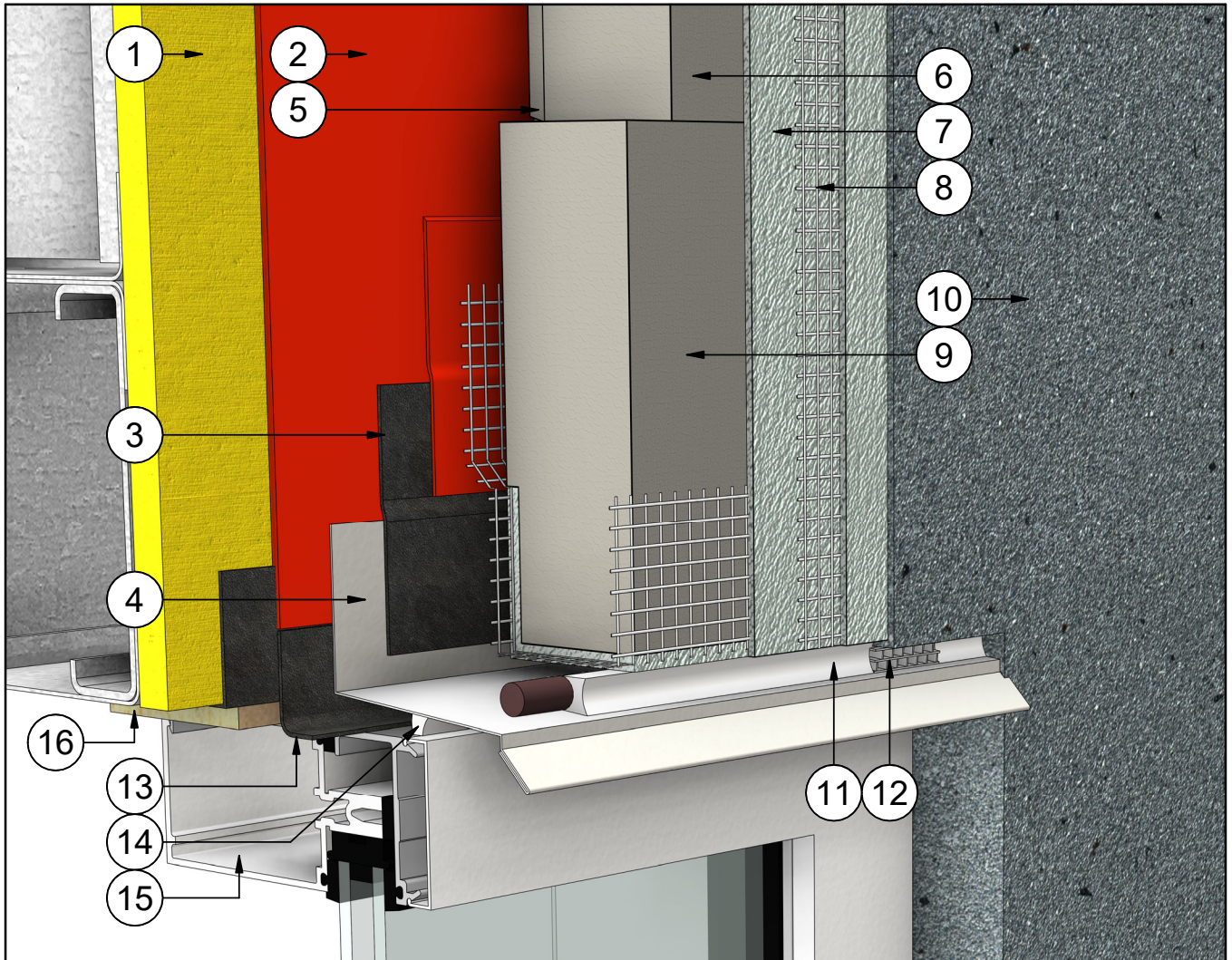

#	Note Text	#	Note Text
1	Steel Studs Frame & Sheathing	9	Insulite Select Vent Board
2	WRB - Water Resistant Barrier	10	Finish Coat
3	Tie In Membrane & Primer	11	Backer Rod & Sealant
4	Flashing w/ End Dams	12	Sealant Vent
5	Insulation Adhesive	13	Transition Membrane
6	Insulite Select Insulation Board	14	Sealant
7	Base Coat	15	Window Assembly
8	Fiberglass Reinforcing Mesh (Embedded in Base Coat)	16	Wood Blocking



Durabond details are offered to assist in the development of project specific details; principles and variables incorporated in all details are the sole responsibility of the project professional(s).

WINDOW HEAD (OPTION B)

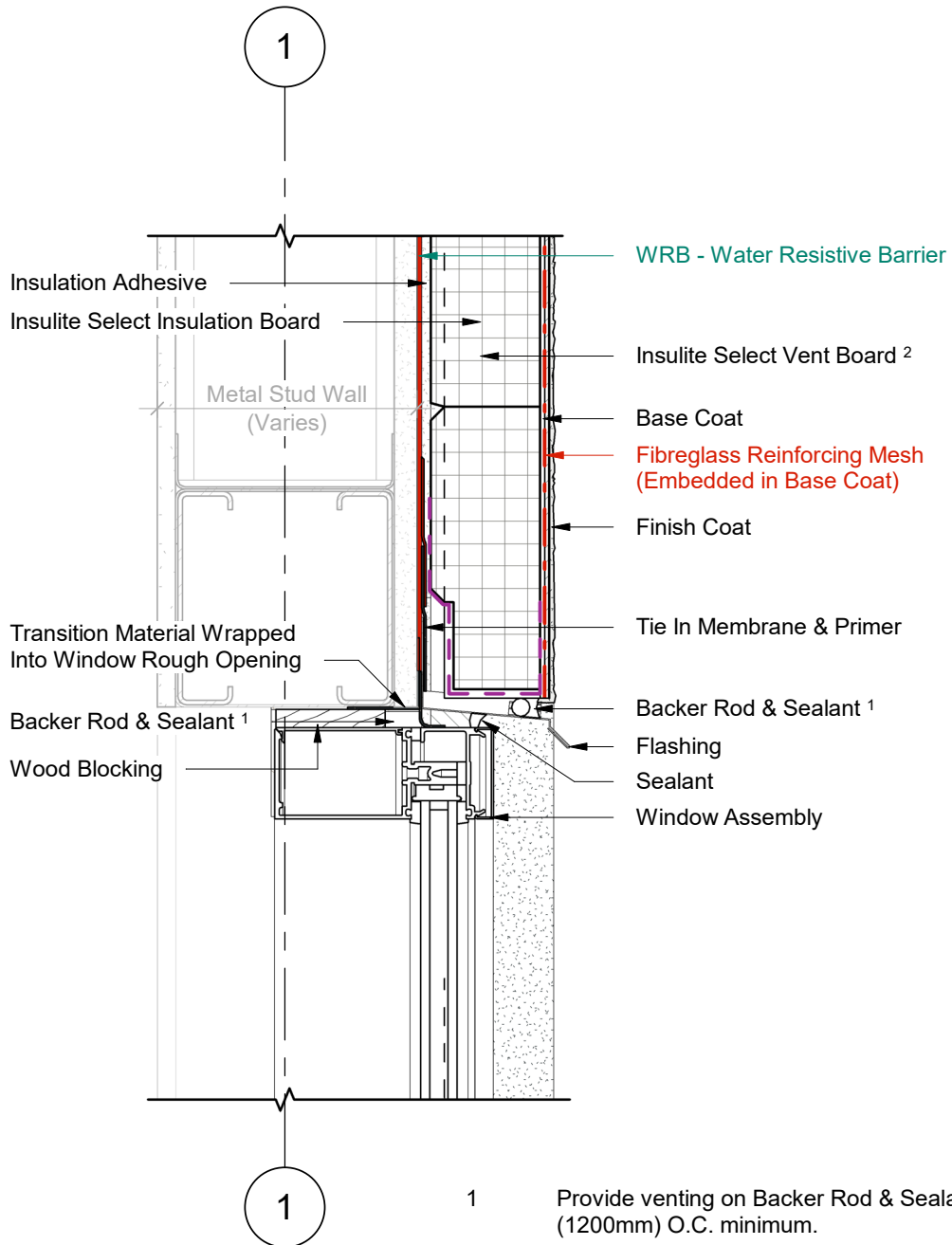

1 Wall Section
2 Scale = 1 : 5

- 1 Provide venting on Backer Rod & Sealant every 48" (1200mm) O.C. minimum.
- 2 Insulite Select Vent Board includes vertical drainage channels & a 2.5" (64mm) back wrapped mesh that is adhered to the board with a Base Coat layer.

DURABOND.

Durabond details are offered to assist in the development of project specific details; principles and variables incorporated in all details are the sole responsibility of the project professional(s).

WINDOW HEAD (OPTION B)

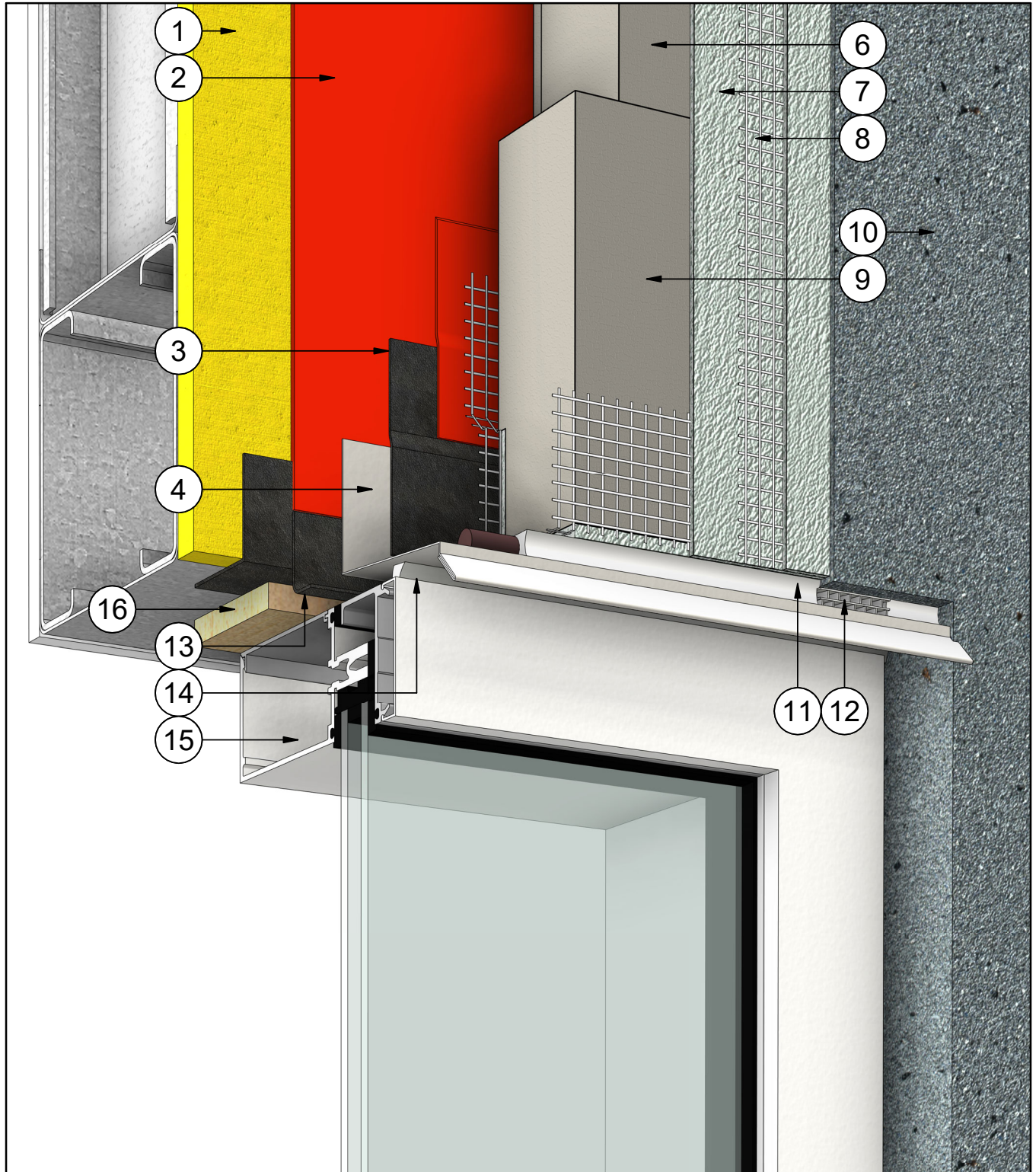

DURABOND.

Durabond details are offered to assist in the development of project specific details; principles and variables incorporated in all details are the sole responsibility of the project professional(s).

WINDOW SILL (OPTION B)

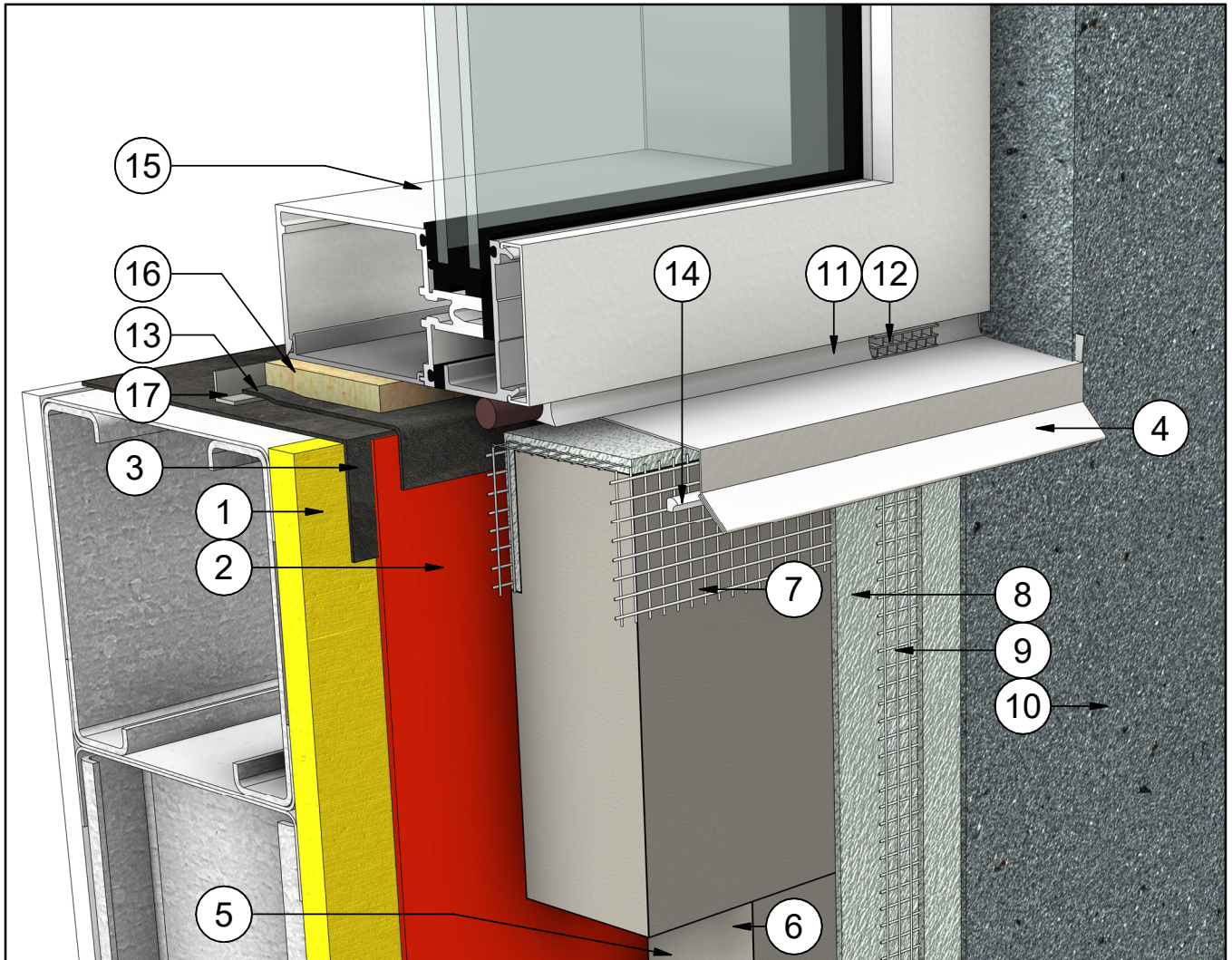

#	Note Text	#	Note Text
1	Steel Studs Frame & Sheathing	10	Finish Coat
2	WRB - Water Resistant Barrier	11	Backer Rod & Sealant
3	Transition Membrane	12	Sealant Vent
4	Flashing w/ End Dams	13	Transition Membrane
5	Insulation Adhesive	14	Sealant
6	Insulite Select Insulation Board	15	Window Assembly
7	Insulite Select Vent Board	16	Wood Blocking
8	Base Coat	17	Drip Deflector
9	Fiberglass Reinforcing Mesh (Embedded in Base Coat)		

DURABOND.

Durabond details are offered to assist in the development of project specific details; principles and variables incorporated in all details are the sole responsibility of the project professional(s).

WINDOW SILL (OPTION B)

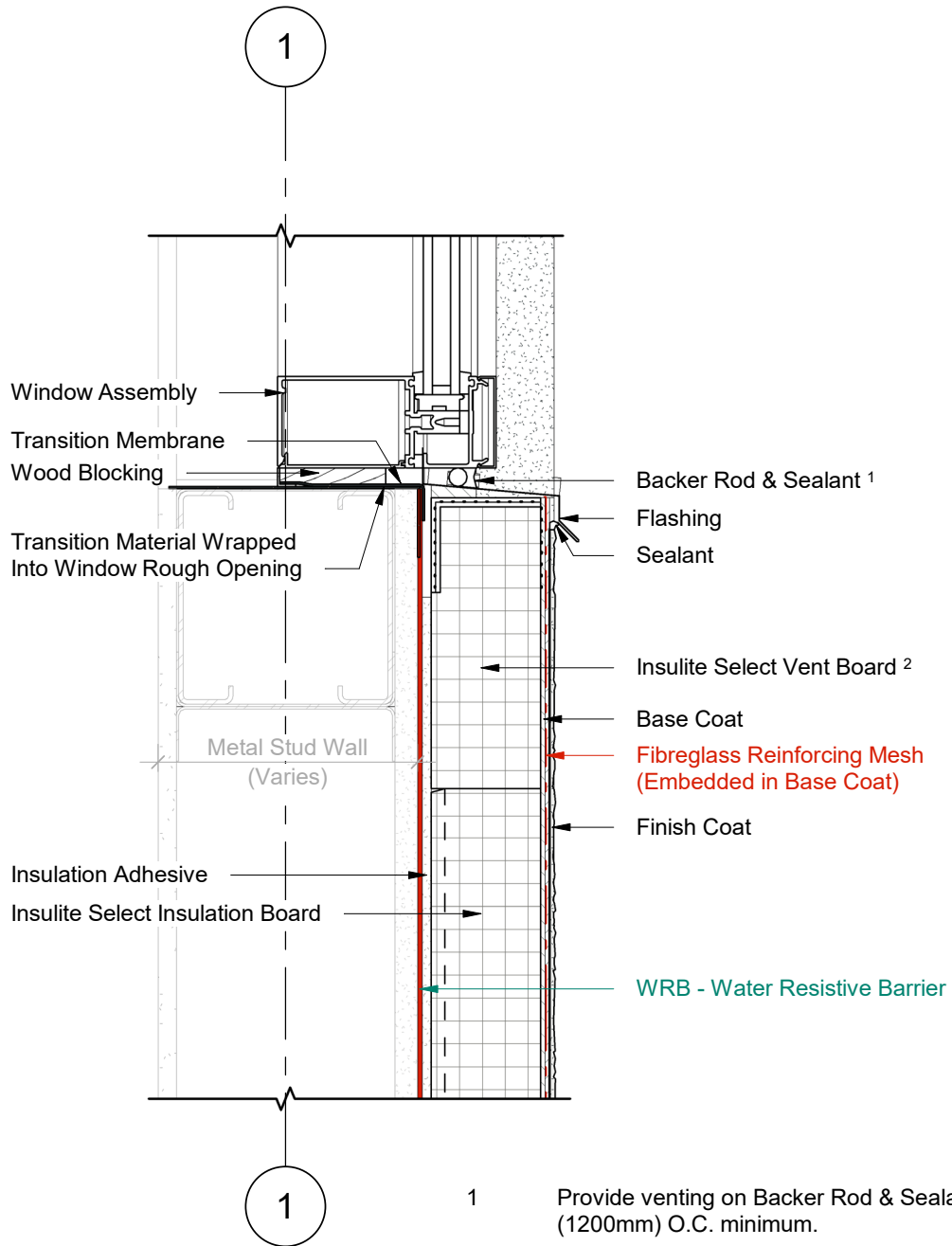

1 Wall Section
2 Scale = 1 : 5

- 1 Provide venting on Backer Rod & Sealant every 48" (1200mm) O.C. minimum.
- 2 Insulite Select Vent Board includes vertical drainage channels & a 2.5" (64mm) back wrapped mesh that is adhered to the board with a Base Coat layer.

DURABOND.

Durabond details are offered to assist in the development of project specific details; principles and variables incorporated in all details are the sole responsibility of the project professional(s).

WINDOW SILL (OPTION B)

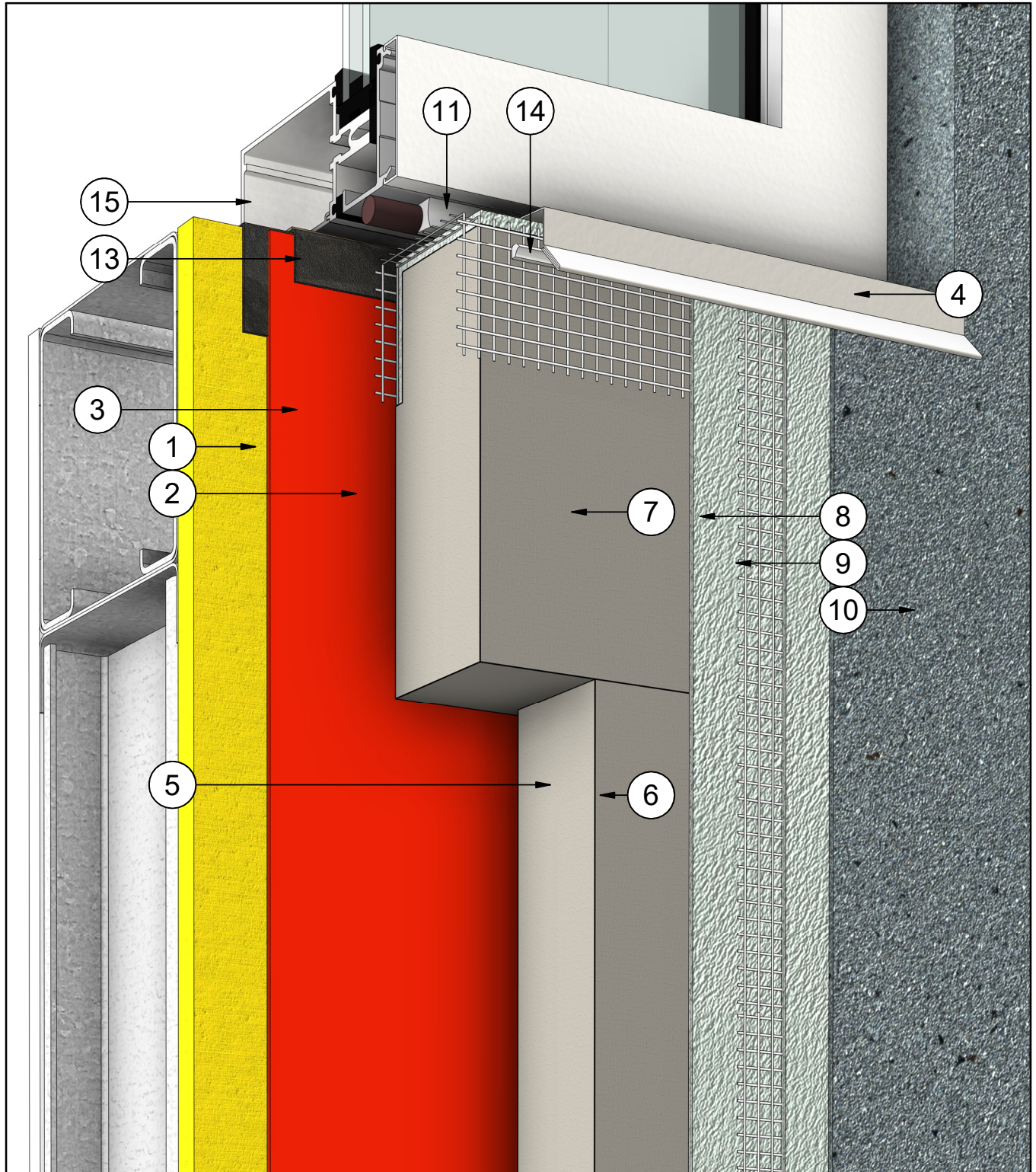

DURabond.

Durabond details are offered to assist in the development of project specific details; principles and variables incorporated in all details are the sole responsibility of the project professional(s).

WINDOW JAMB (OPTION B)

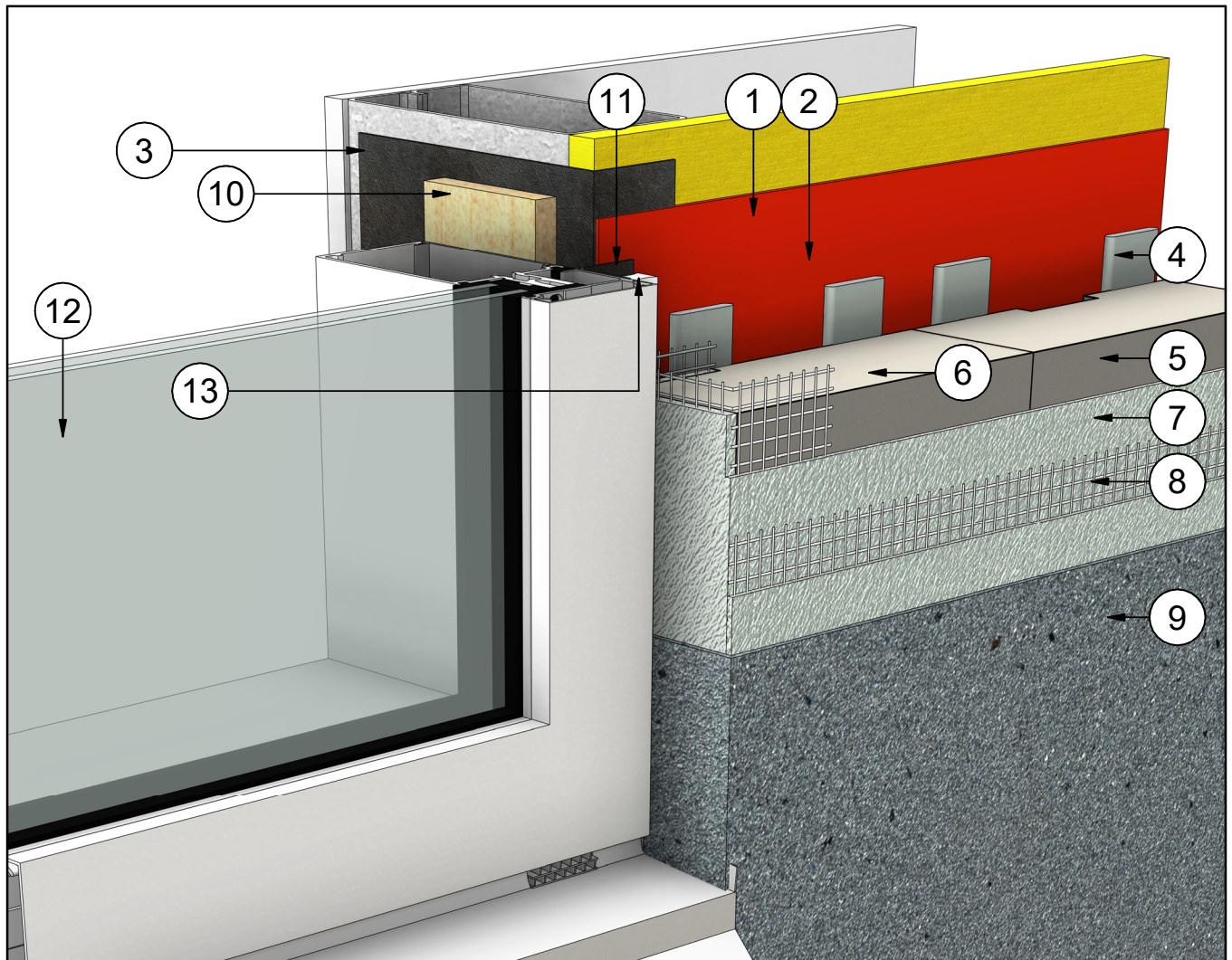

#	Note Text	#	Note Text
1	Steel Studs Frame & Sheathing	9	Finish Coat
2	WRB - Water Resistant Barrier	10	Wood Blocking
3	Transition Membrane	11	Transition Membrane
4	Insulation Adhesive	12	Window Assembly
5	Insulite Select Insulation Board	13	Sealant
6	Insulite Select Boundary Board		
7	Base Coat		
8	Fiberglass Reinforcing Mesh (Embedded in Base Coat)		

DURABOND.

Durabond details are offered to assist in the development of project specific details; principles and variables incorporated in all details are the sole responsibility of the project professional(s).

WINDOW JAMB (OPTION B)

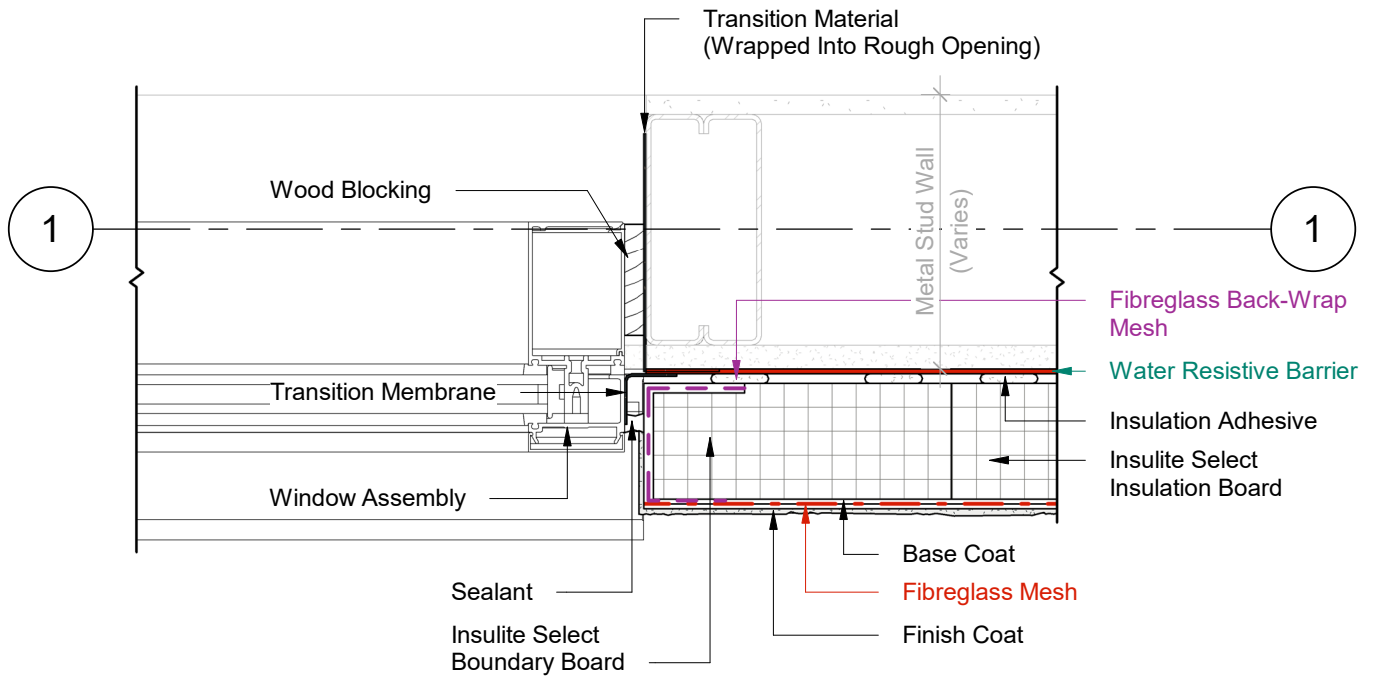

1 Plan Detail
2 Scale = 1:5

- 1 Provide venting on Backer Rod & Sealant every 48" (1200mm) O.C. minimum.
- 2 Insulite Select Vent Board includes vertical drainage channels & a 2.5" (64mm) back wrapped mesh that is adhered to the board with a Base Coat layer.



Durabond details are offered to assist in the development of project specific details; principles and variables incorporated in all details are the sole responsibility of the project professional(s).

WINDOW JAMB (OPTION B)

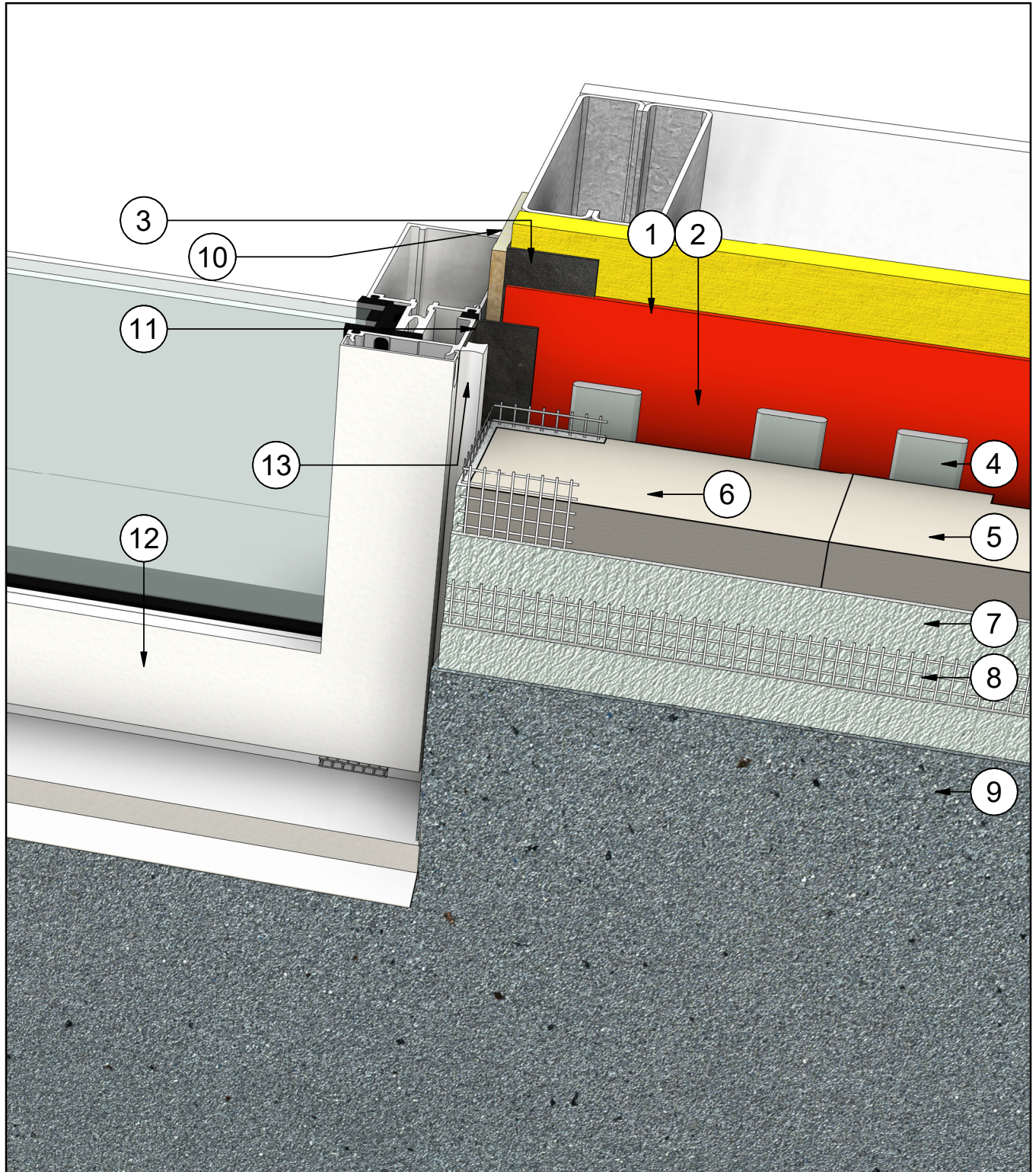

DURabond.

Durabond details are offered to assist in the development of project specific details; principles and variables incorporated in all details are the sole responsibility of the project professional(s).

PARAPET DETAIL

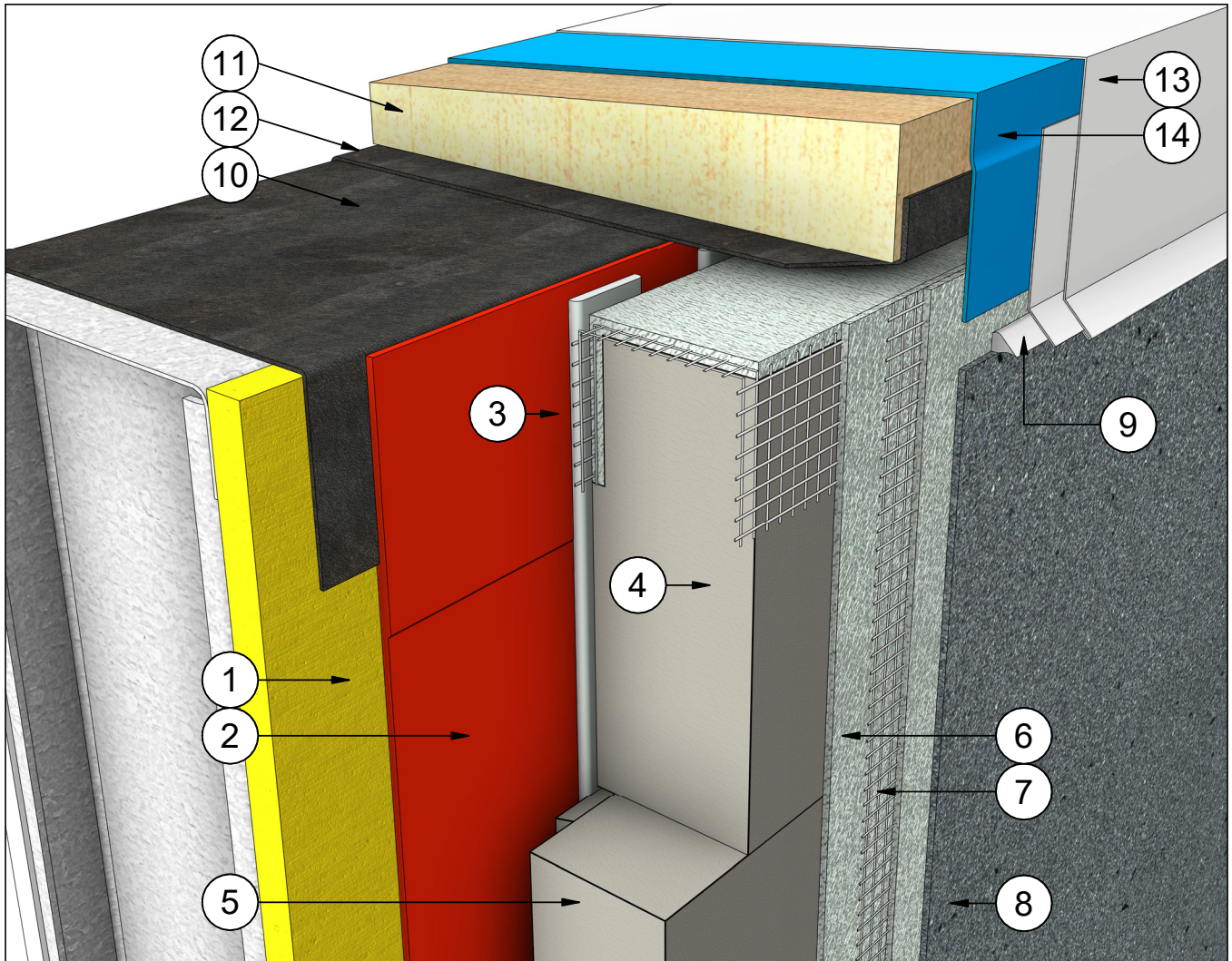

#	Note Text	#	Note Text
1	Steel Studs Frame & Sheathing	9	Low Modulus Sealant
2	Water Resistive Barrier	10	Transition Material Over Wall Assembly
3	Insulation Adhesive	11	Wood Blocking
4	Insulite Select Boundary Board	12	Transition Material from Back of Wall to Front of Wall
5	Insulite Select Insulation Board	13	Parapet Flashing & Counterflashing
6	Base Coat	14	Roof System Waterproof Membrane
7	Fibreglass Reinforcing Mesh (Embedded in Base Coat)		
8	Finish Coat		

DURABOND.

Durabond details are offered to assist in the development of project specific details; principles and variables incorporated in all details are the sole responsibility of the project professional(s).

PARAPET DETAIL

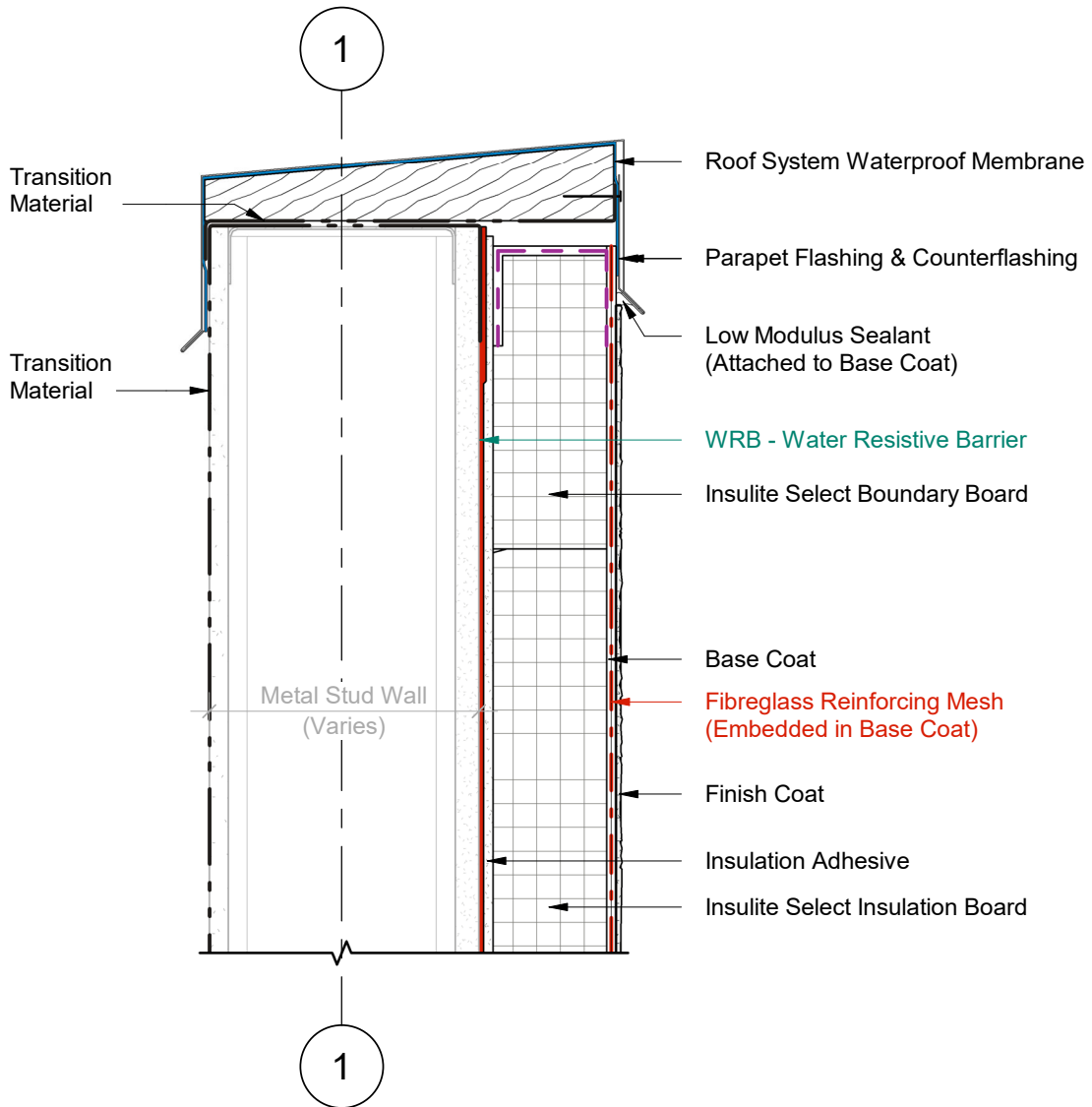

DURABOND.

Durabond details are offered to assist in the development of project specific details; principles and variables incorporated in all details are the sole responsibility of the project professional(s).

PARAPET DETAIL

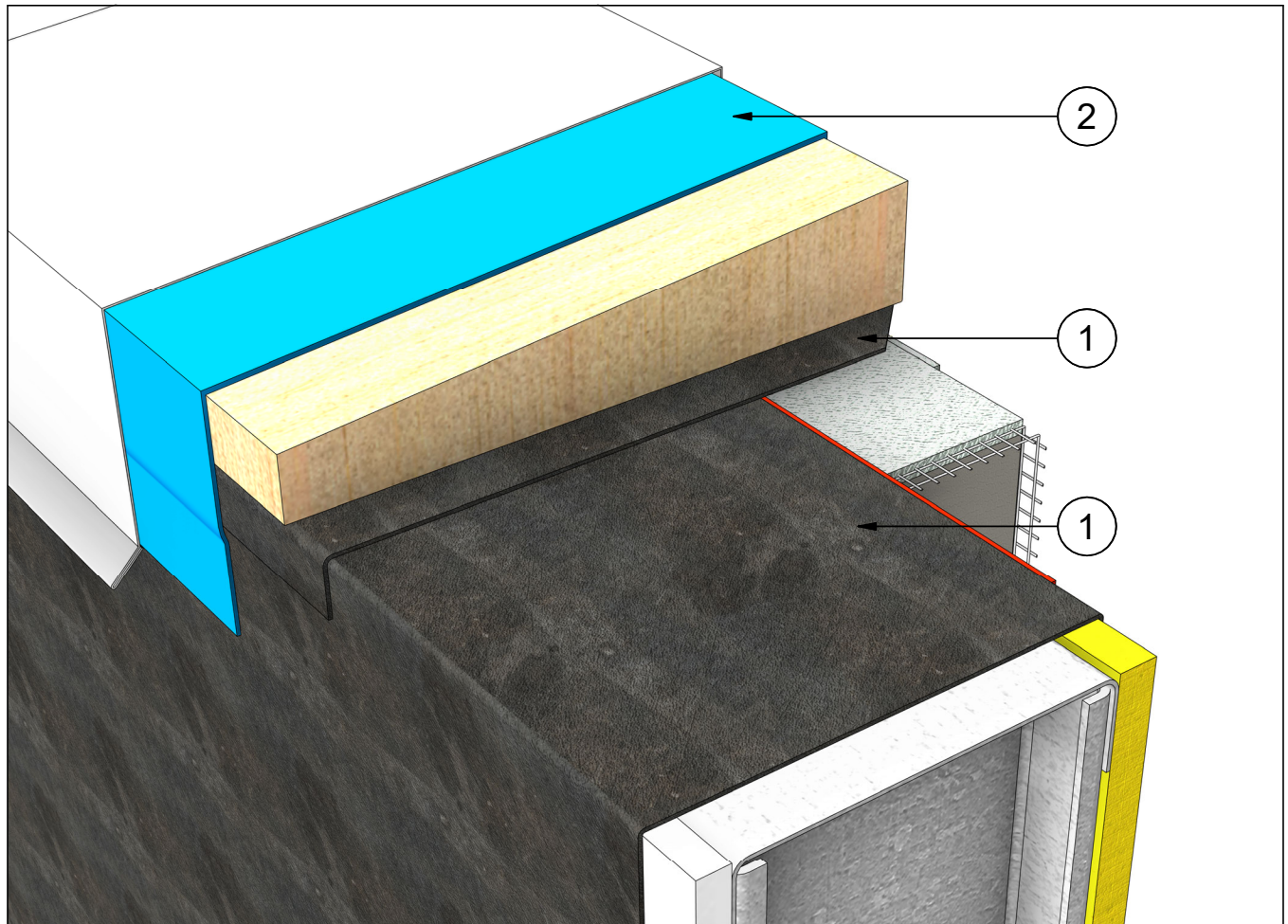

MEMBRANE SPECIFICS

1 Transition Material

There are two **transition membranes** needed to complete the parapet. The first membrane transitions between the backside of the wall and the water resistive barrier.

The second membrane then lines the bottom of the wood blocking. It gets overlapped on both sides of the wall by the **air & vapour barrier**. These two layers of transition material ensure that the drainage remains positive at both the front & back of the wall.

2 Roof System Waterproof Membrane

The roof waterproofing membrane, typically an air & vapour barrier, is located directly beneath the metal flashing. It wraps over the entirety of the wall and ensures that the parapet is protected from the elements.

DURABOND.

Durabond details are offered to assist in the development of project specific details; principles and variables incorporated in all details are the sole responsibility of the project professional(s).

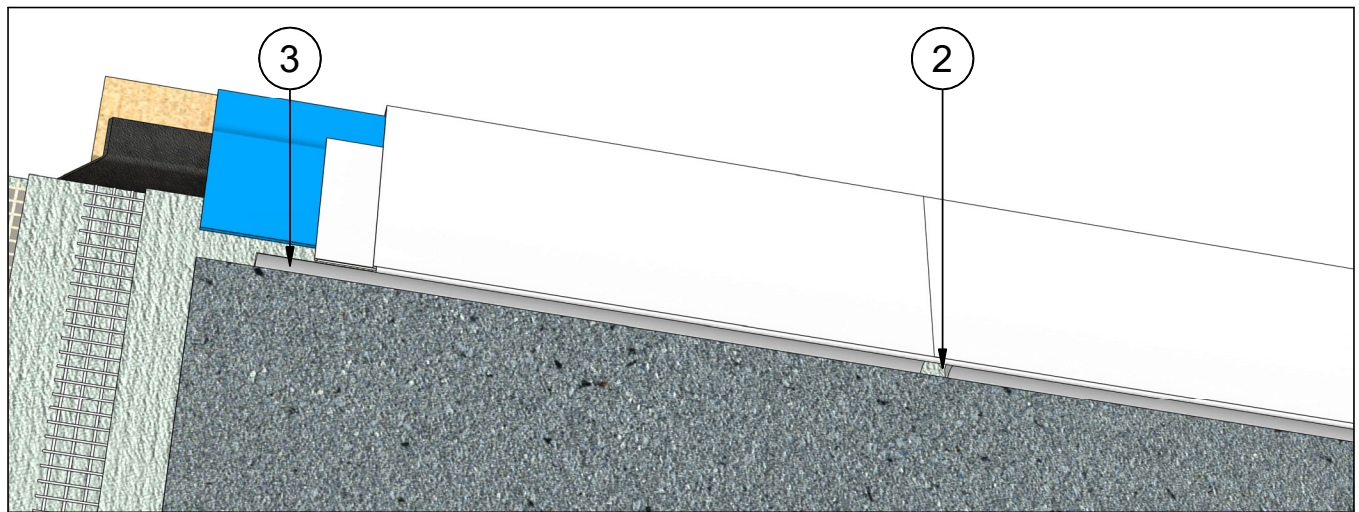
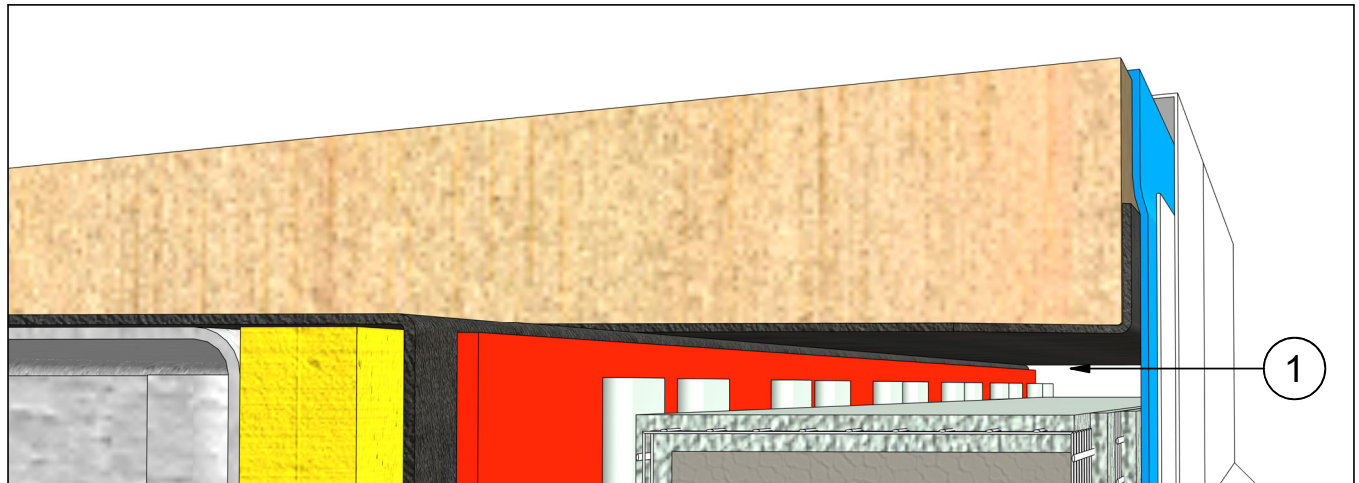
PARAPET DETAIL**AIR SPACE & SEALANT SPECIFICS**

- 1 Provide a 1/2" (13mm) Air Space**

The air space at the top of the wall allows for the wall assembly to expand & contract freely without damaging the parapet.
- 2 Provide a 1/2" (13mm) Air Space**

When the parapet has a seam in the metal flashing, the sealant should be broken to allow the system to vent freely.
- 3 Sealant Attached to Base Coat**

The sealant is attached directly to the base layer. The finish coat is then applied to complete the wall; it abuts against the sealant.

DURABOND.

Durabond details are offered to assist in the development of project specific details; principles and variables incorporated in all details are the sole responsibility of the project professional(s).

SOFFIT INTERFACE WITH OVERHANG

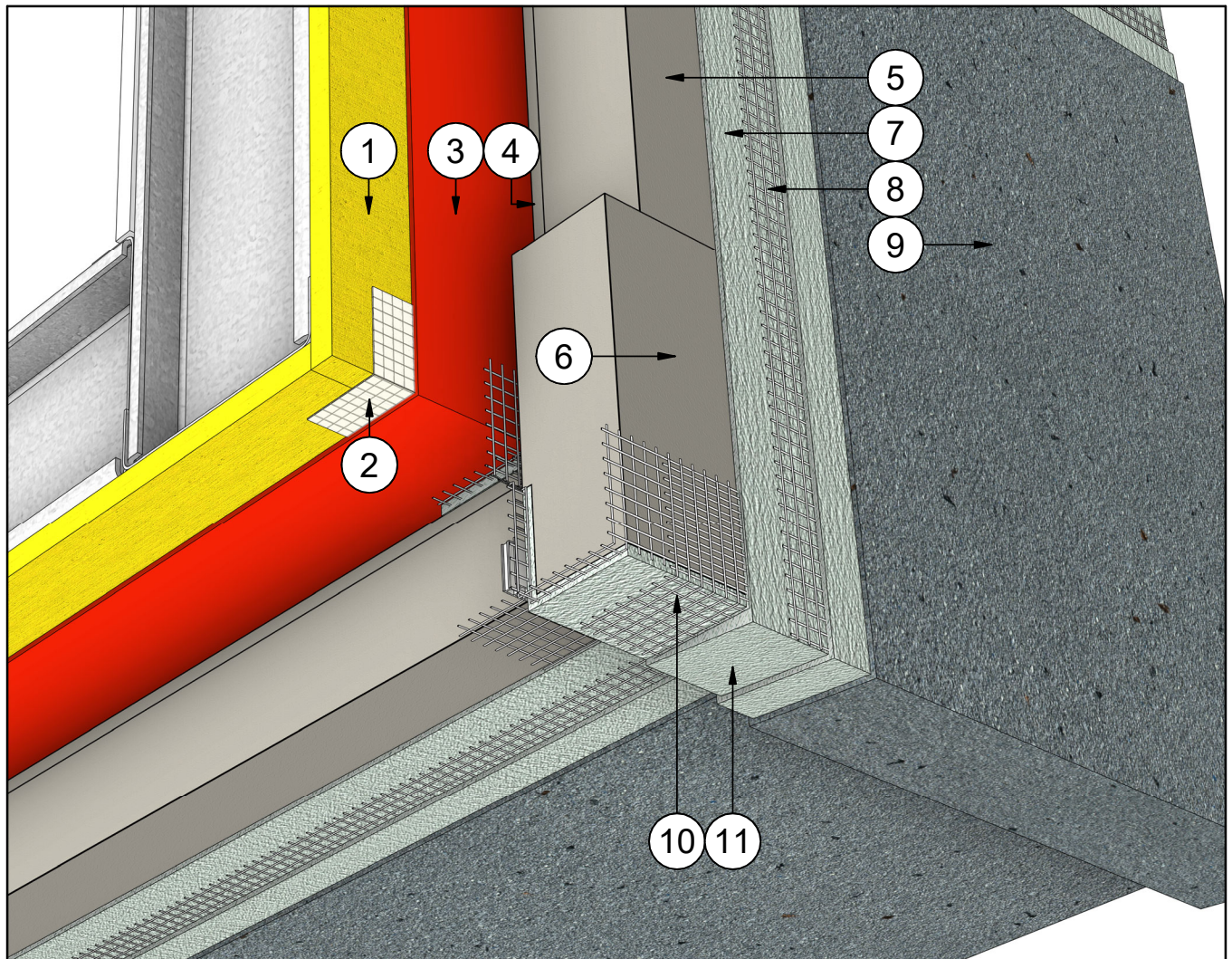

Note Text

- 1 Steel Studs Frame & Sheathing
- 2 Barrier Seam Tape (Embedded in WRB)
- 3 WRB - Water Resistive Barrier
- 4 Insulation Adhesive
- 5 Insulite Select Insulation Board
- 6 Insulite Select Vent Board
- 7 Base Coat
- 8 Fibreglass Reinforcing Mesh (Embedded in Base Coat)
- 9 Finish Coat
- 10 Fiberglass Corner Mesh (Embedded in Base Coat)
- 11 Base Coat Sloped for Drainage
- 12 Durex Continous Drainage Vent

DURABOND.

Durabond details are offered to assist in the development of project specific details; principles and variables incorporated in all details are the sole responsibility of the project professional(s).

SOFFIT INTERFACE WITH OVERHANG

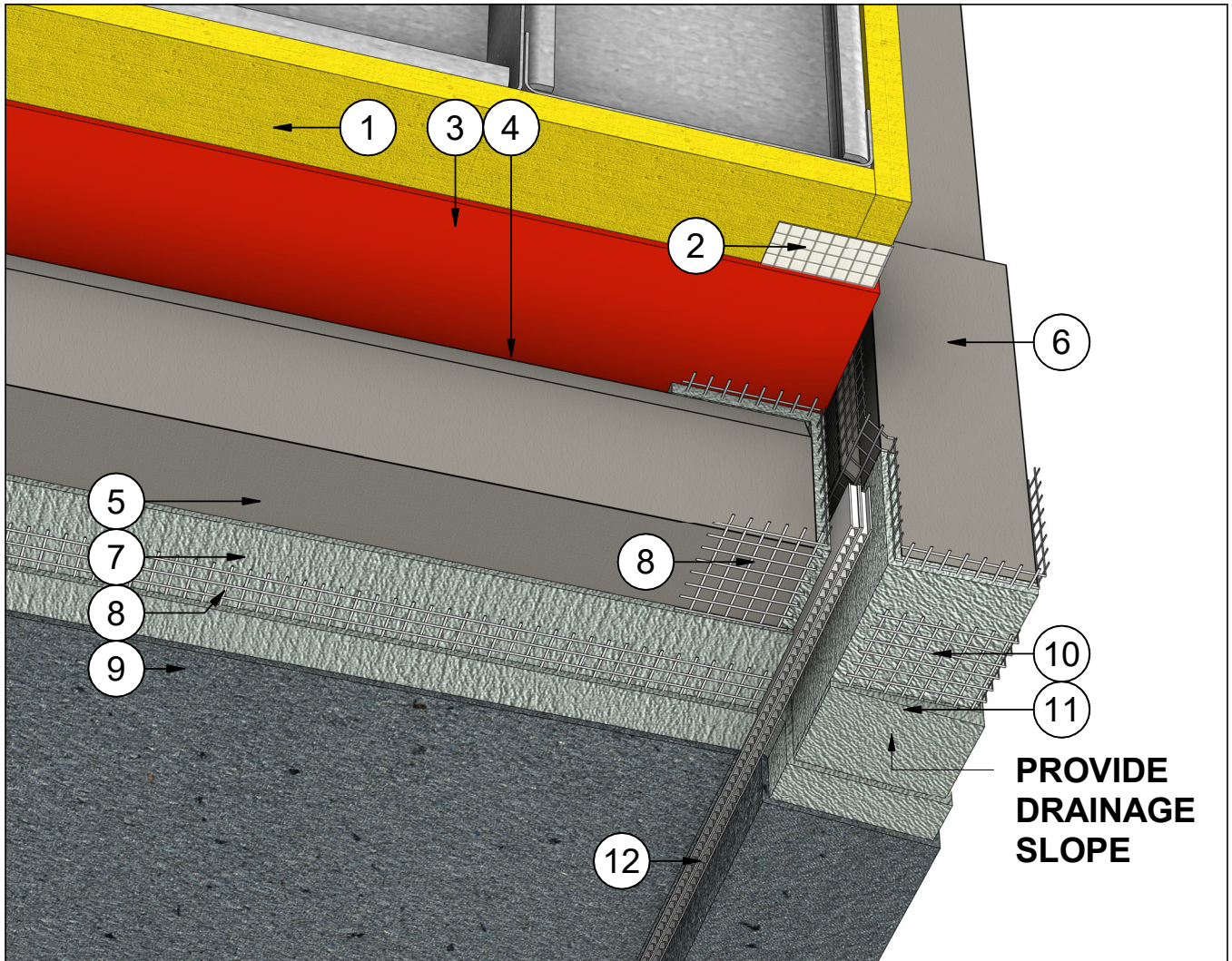

Note Text

- 1 Steel Studs Frame & Sheathing
- 2 Barrier Seam Tape (Embedded in WRB)
- 3 WRB - Water Resistive Barrier
- 4 Insulation Adhesive
- 5 Insulite Select Insulation Board
- 6 Insulite Select Vent Board
- 7 Base Coat
- 8 Fibreglass Reinforcing Mesh (Embedded in Base Coat)
- 9 Finish Coat
- 10 Fibreglass Corner Mesh (Embedded in Base Coat)
- 11 Base Coat Sloped for Drainage
- 12 Durex Continuous Drainage Vent

DURABOND.

Durabond details are offered to assist in the development of project specific details; principles and variables incorporated in all details are the sole responsibility of the project professional(s).

SOFFIT INTERFACE WITH OVERHANG

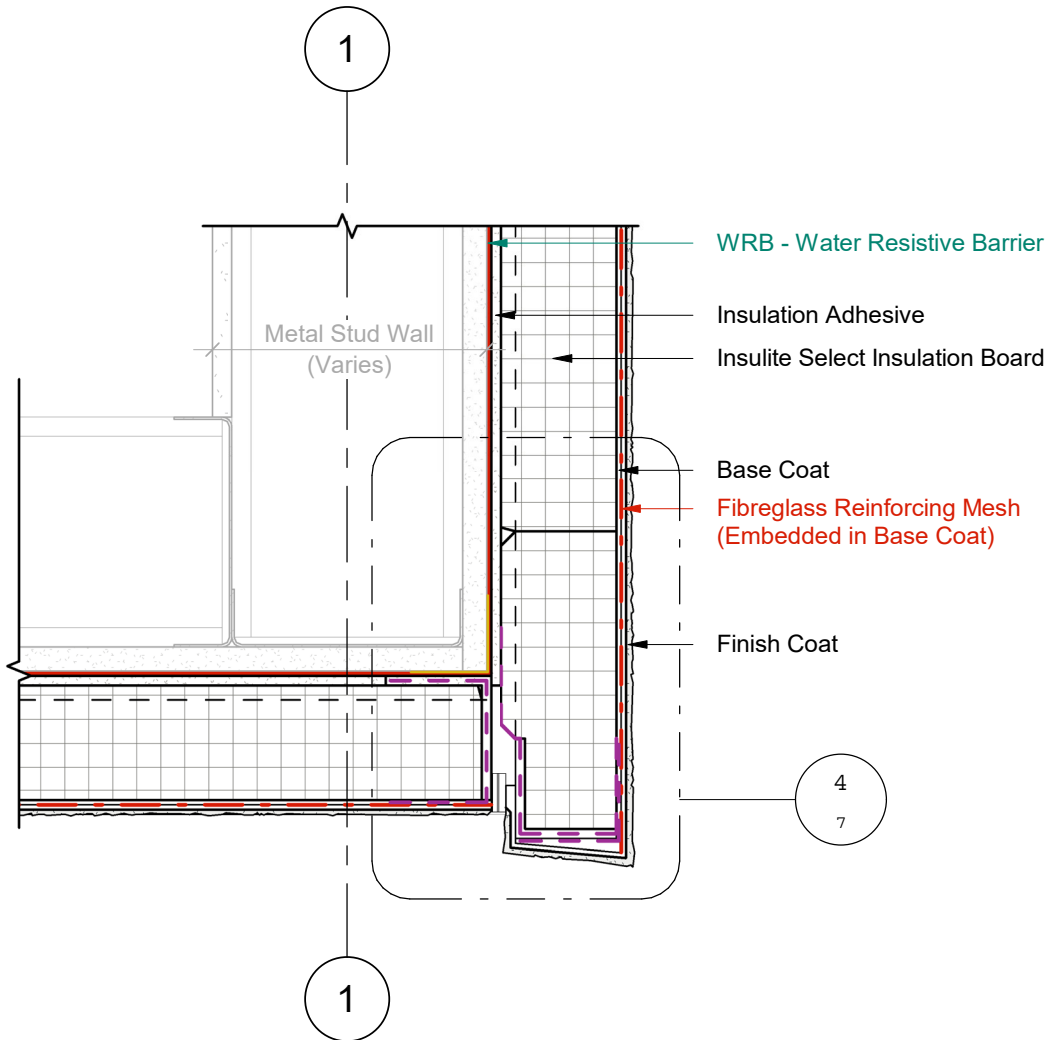

1 Wall Section
3 Scale = 1 : 5

SOFFIT INTERFACE WITH OVERHANG

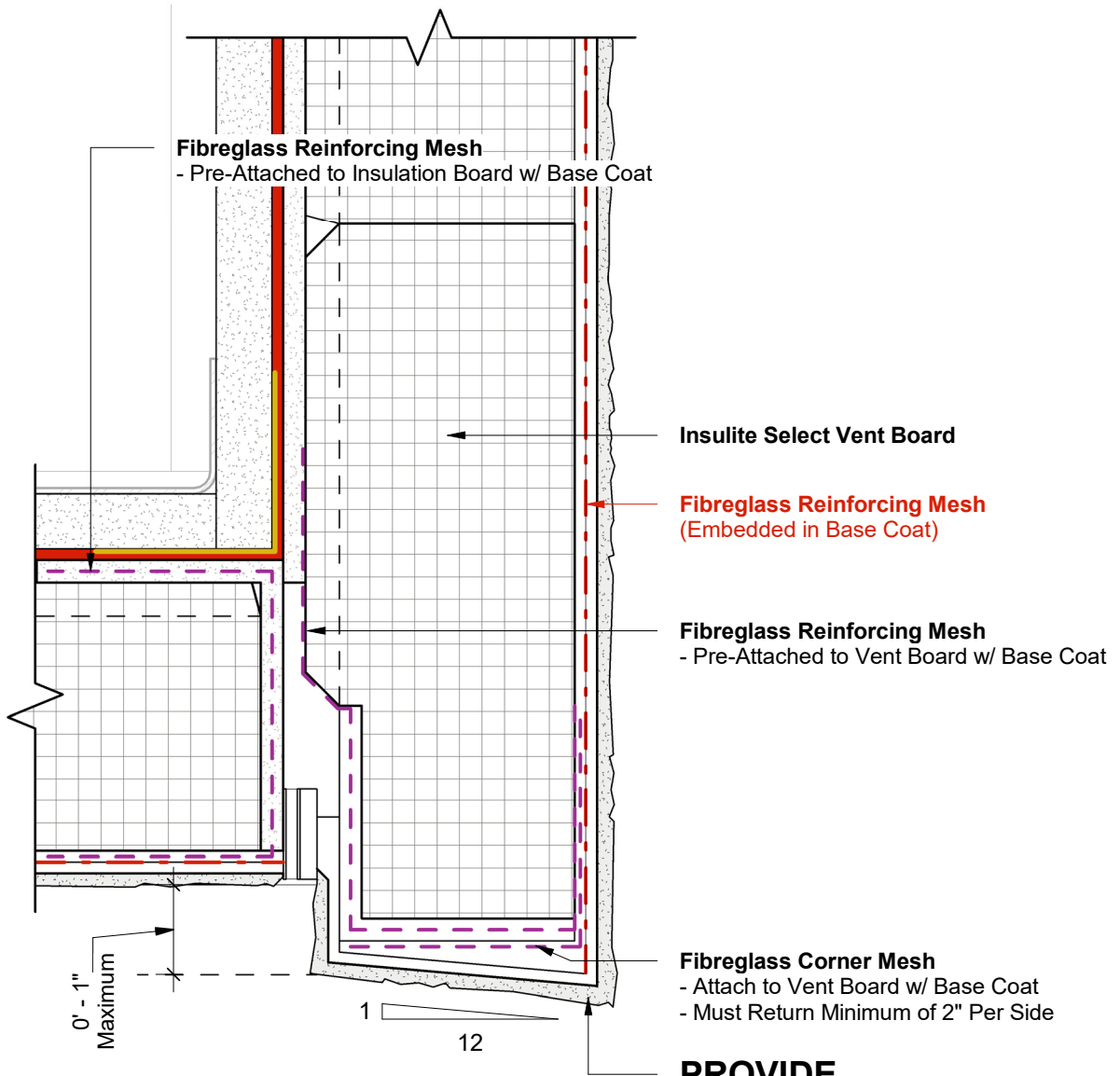

1 Wall Section - Callout 1
4 Scale = 6" = 1'-0"

**PROVIDE
DRAINAGE
SLOPE**

SOFFIT INTERFACE WITH FLUSH JOINT

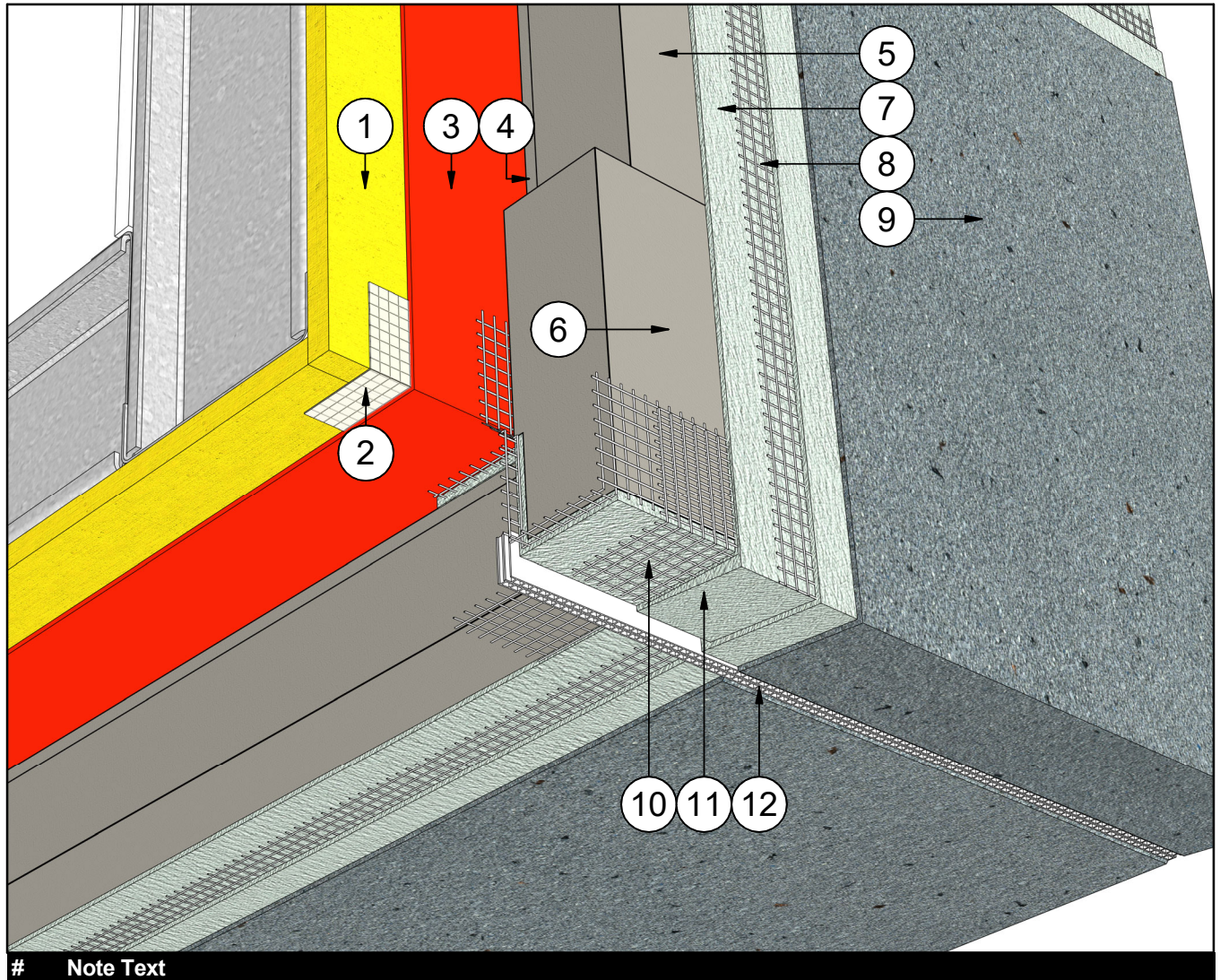

#	Note Text
1	Steel Studs Frame & Sheathing
2	Barrier Seam Tape (Embedded in WRB)
3	WRB - Water Resistive Barrier
4	Insulation Adhesive
5	Insulite Select Insulation Board
6	Insulite Select Vent Board
7	Base Coat
8	Fibreglass Reinforcing Mesh (Embedded in Base Coat)
9	Finish Coat
10	Fibreglass Corner Mesh (Embedded in Base Coat)
11	Base Coat Sloped for Drainage
12	Durex Continuous Drainage Vent

DURABOND.

Durabond details are offered to assist in the development of project specific details; principles and variables incorporated in all details are the sole responsibility of the project professional(s).

SOFFIT INTERFACE WITH FLUSH JOINT

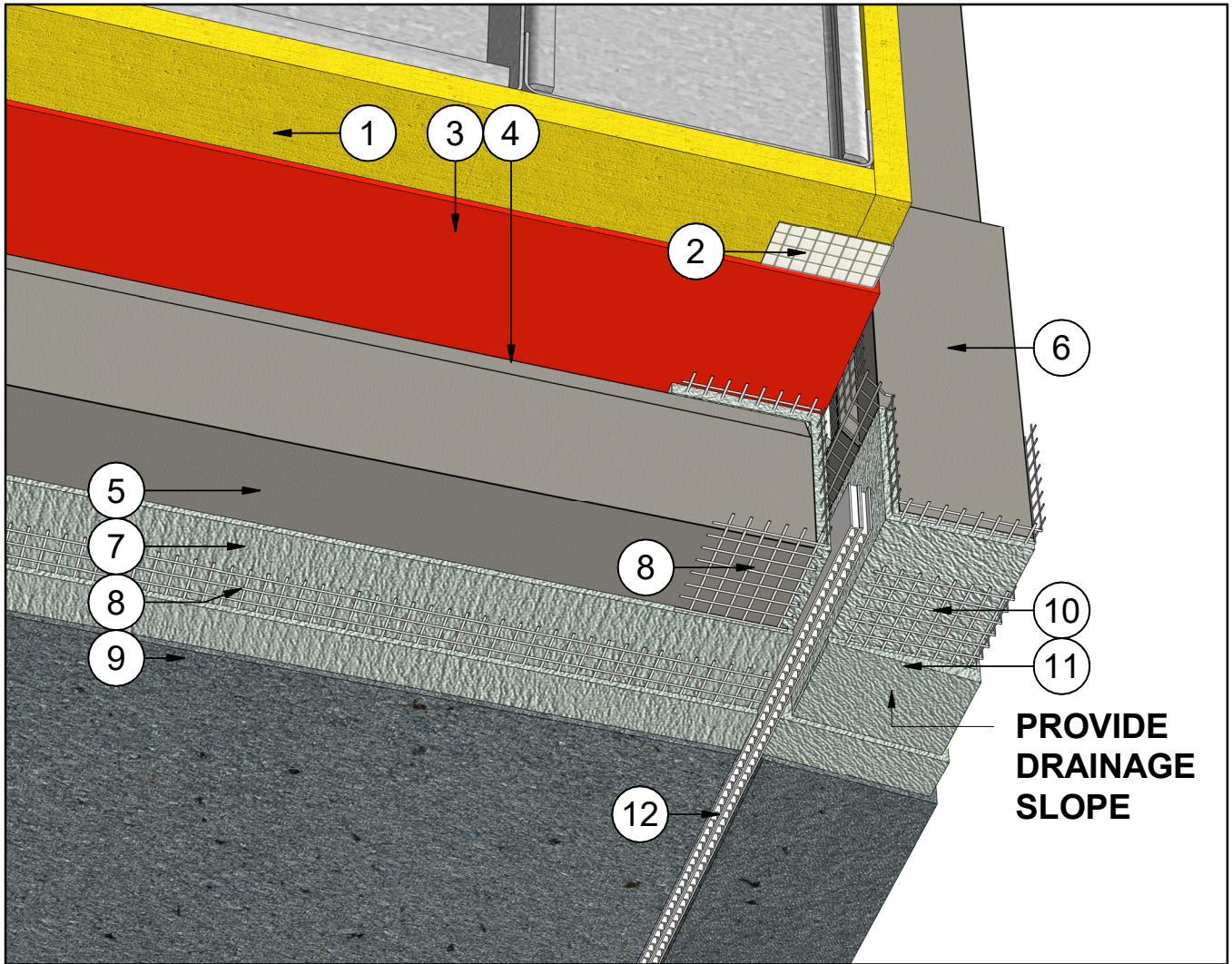

#	Note Text
1	Steel Studs Frame & Sheathing
2	Barrier Seam Tape (Embedded in WRB)
3	WRB - Water Resistive Barrier
4	Insulation Adhesive
5	Insulite Select Insulation Board
6	Insulite Select Vent Board
7	Base Coat
8	Fibreglass Reinforcing Mesh (Embedded in Base Coat)
9	Finish Coat
10	Fibreglass Corner Mesh (Embedded in Base Coat)
11	Base Coat Sloped for Drainage
12	Durex Continuous Drainage Vent

DURABOND.

Durabond details are offered to assist in the development of project specific details; principles and variables incorporated in all details are the sole responsibility of the project professional(s).

SOFFIT INTERFACE WITH FLUSH JOINT

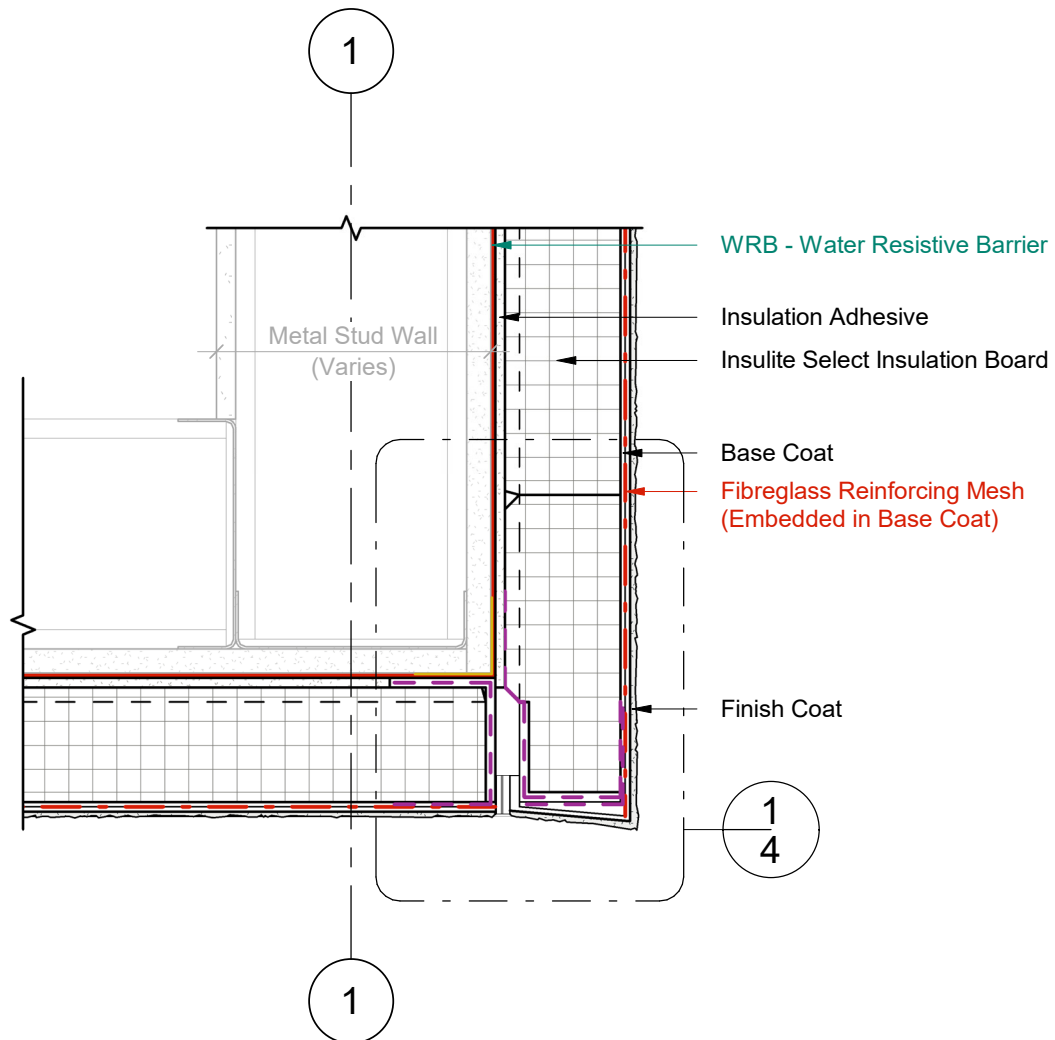

1 Wall Section
3 Scale = 1 : 5

SOFFIT INTERFACE WITH FLUSH JOINT

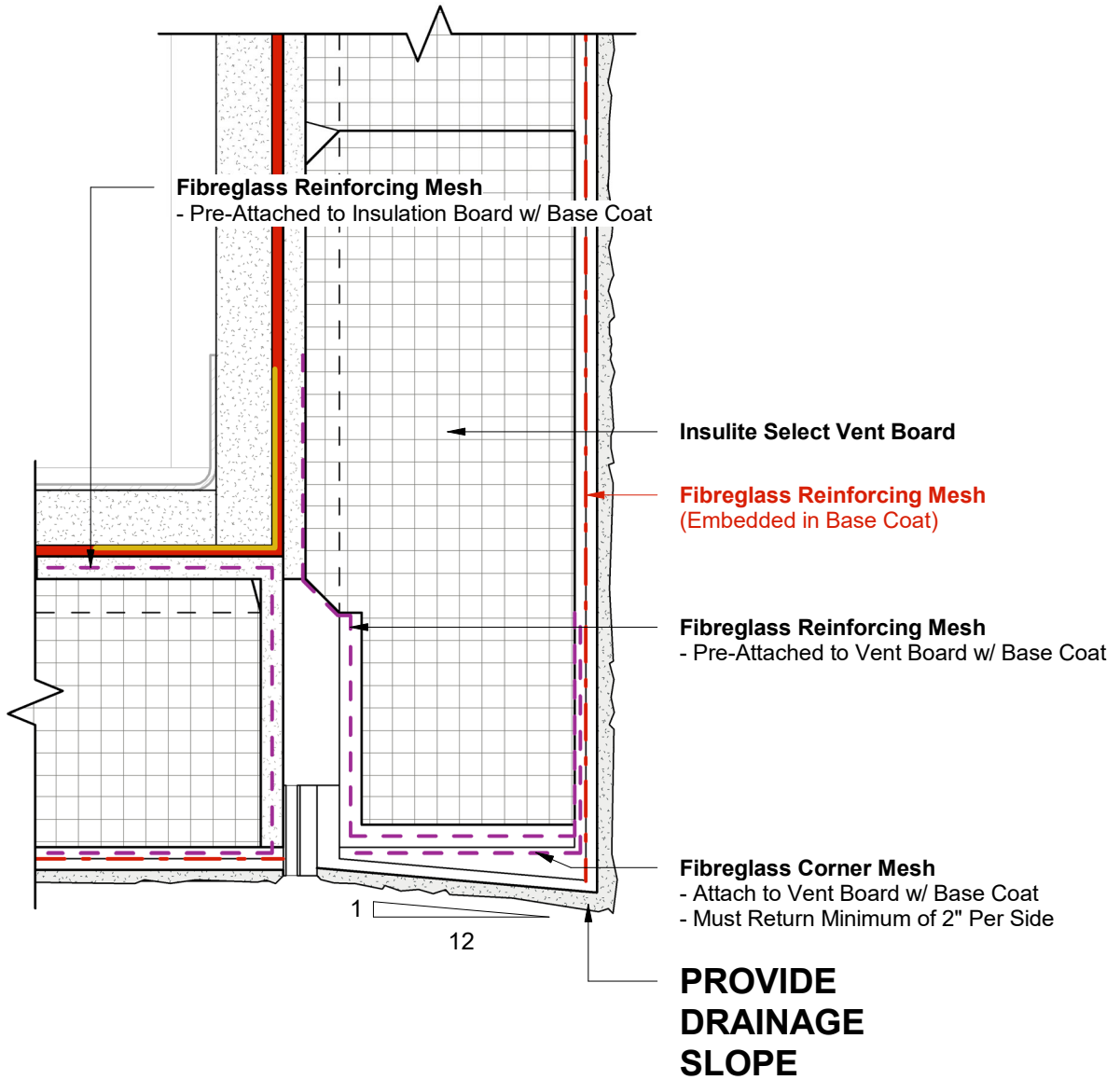

1 Wall Section - Callout 1
4 Scale = 6" = 1'-0"



Durabond details are offered to assist in the development of project specific details; principles and variables incorporated in all details are the sole responsibility of the project professional(s).

STUCCO SOFFIT INTERFACE WITH FLUSH JOINT

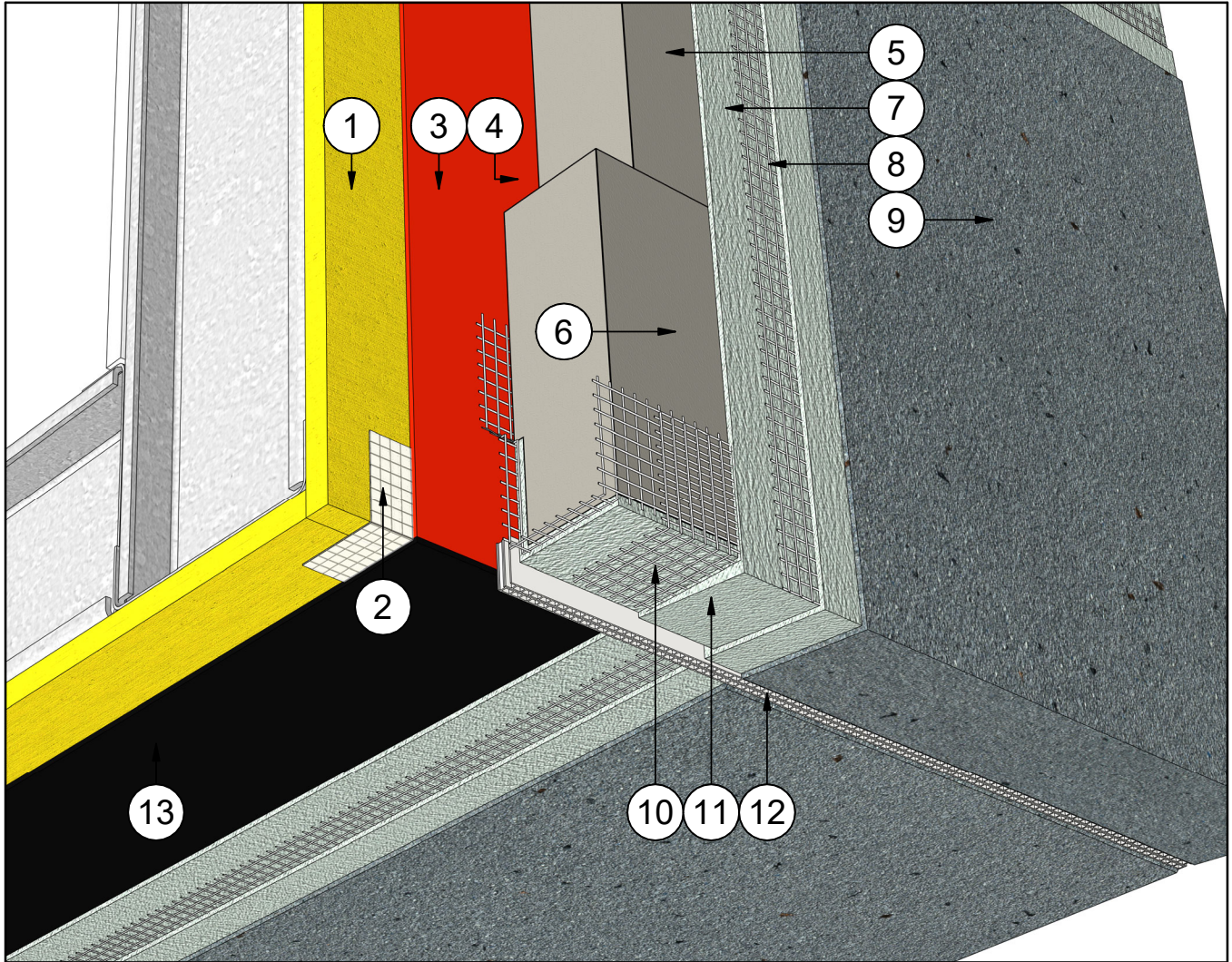

#	Note Text	#	Note Text
1	Steel Studs Frame & Sheathing	8	Fibreglass Reinforcing Mesh (Embedded in Base Coat)
2	Barrier Seam Tape (Embedded in WRB)	9	Finish Coat
3	WRB - Water Resistive Barrier	10	Fibreglass Corner Mesh (Embedded in Base Coat)
4	Insulation Adhesive	11	Base Coat Sloped for Drainage
5	Insulite Select Insulation Board	12	Durex Continuous Drainage Vent
6	Insulite Select Vent Board	13	Air & Vapour Barrier
7	Base Coat		

DURABOND.

Durabond details are offered to assist in the development of project specific details; principles and variables incorporated in all details are the sole responsibility of the project professional(s).

STUCCO SOFFIT INTERFACE WITH FLUSH JOINT

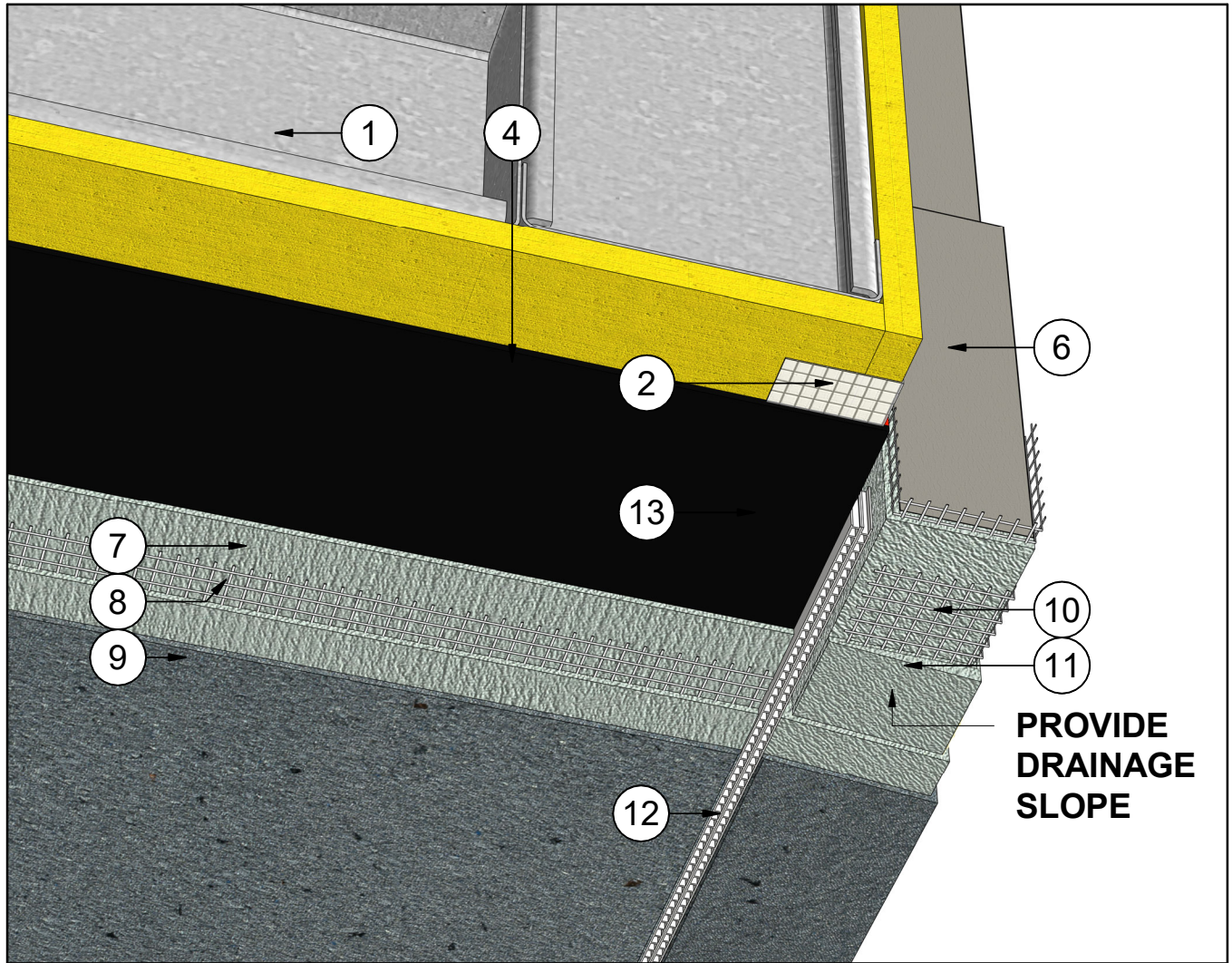

#	Note Text	#	Note Text
1	Steel Studs Frame & Sheathing	8	Fibreglass Reinforcing Mesh (Embedded in Base Coat)
2	Barrier Seam Tape (Embedded in WRB)	9	Finish Coat
3	WRB - Water Resistive Barrier	10	Fibreglass Corner Mesh (Embedded in Base Coat)
4	Insulation Adhesive	11	Base Coat Sloped for Drainage
5	Insulite Select Insulation Board	12	Durex Continuous Drainage Vent
6	Insulite Select Vent Board	13	Air & Vapour Barrier
7	Base Coat		



Durabond details are offered to assist in the development of project specific details; principles and variables incorporated in all details are the sole responsibility of the project professional(s).

STUCCO SOFFIT INTERFACE WITH FLUSH JOINT

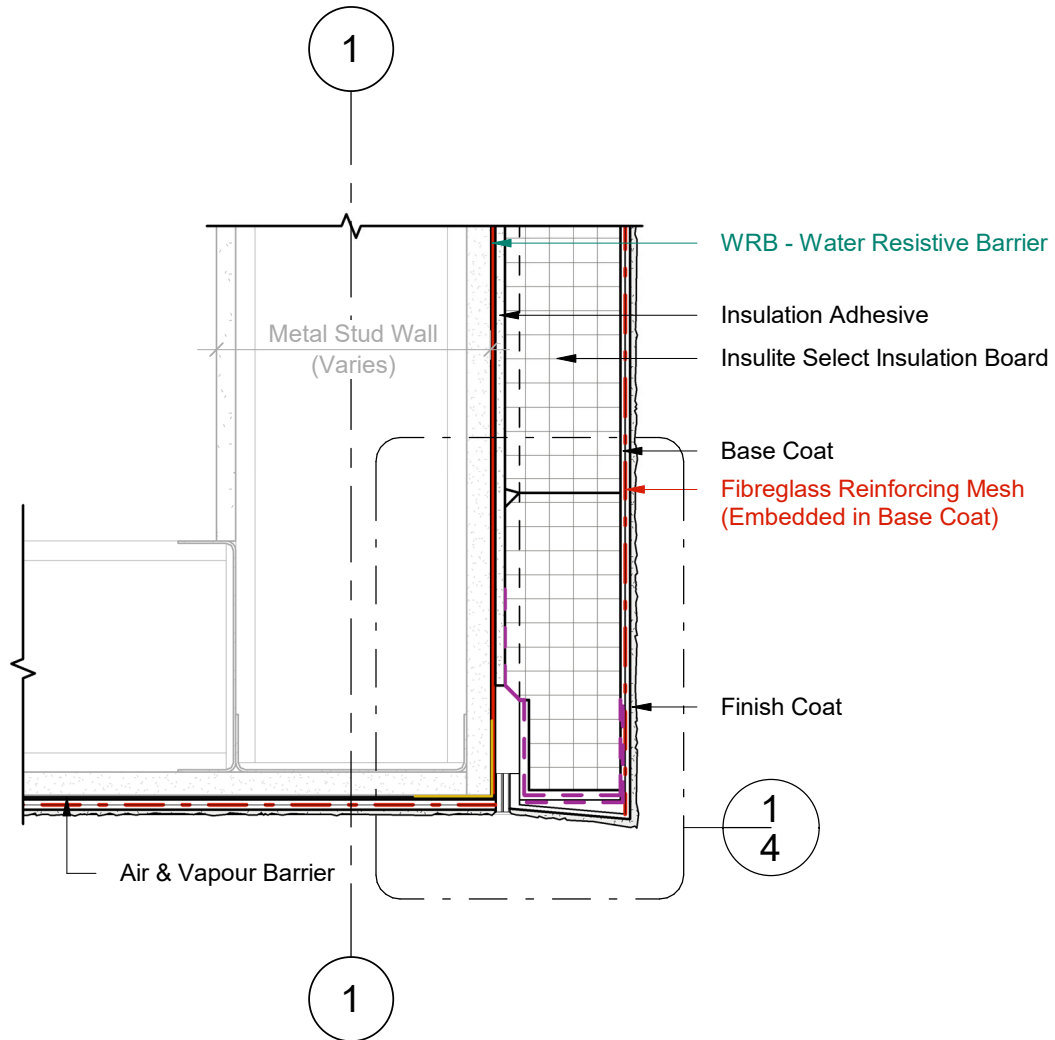

1 Wall Section
3 Scale = 1 : 5

STUCCO SOFFIT INTERFACE WITH FLUSH JOINT

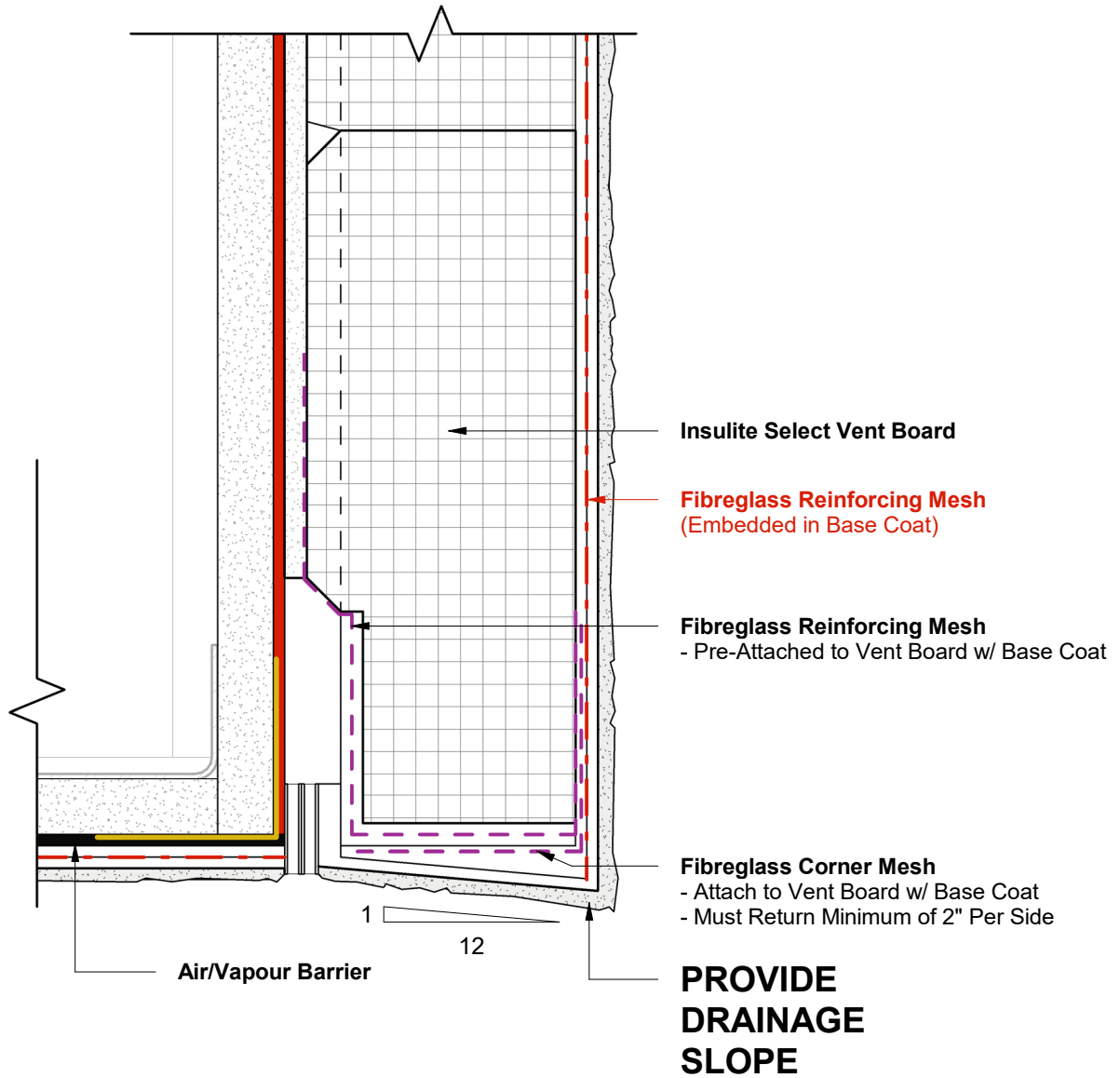

1 Wall Section - Callout 1
4 Scale = 6" = 1'-0"