

Durex® Equalite

NON-COMBUSTIBLE SYSTEM

Non-Combustible Pressure Equalized Mineral
Fiber Insulation Finish System

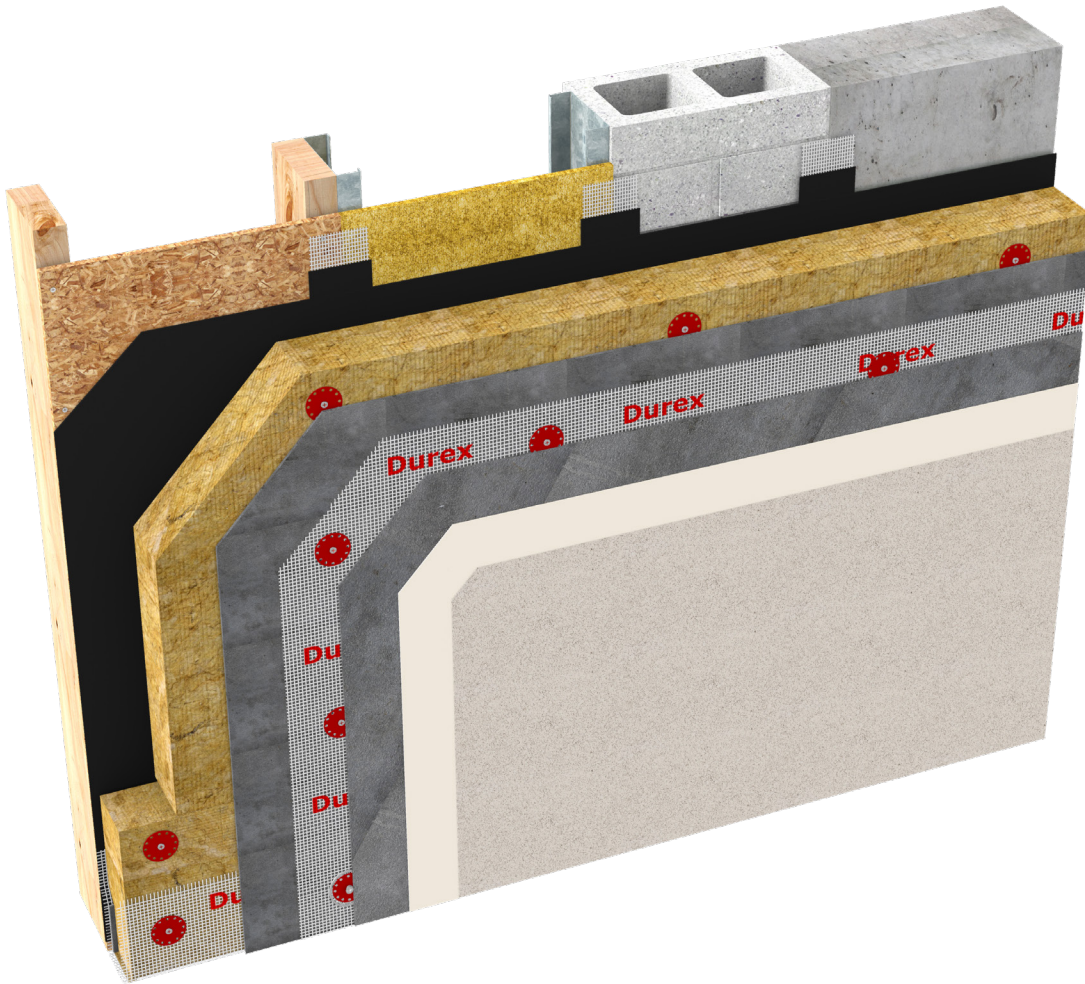

CCMC 13103-R

CAN/ULC S716.1 Materials

CAN/ULC S716.2 Installations

CAN/ULC S716.3 Design Application

G.D.D.C Factor = 25%

C.I Factor = 0.70 RSI/Inch Semi-Rigid Mineral



Non-Combustible



Impact
Resistance Ultra
High



Eco-Friendly



Acoustic
Resistance

Protect. Enhance. Outperform.

DURAbond **50**
YEARS
1967-2017
1-877-387-2266 info@durabond.com
www.durabond.com

Durex®

Equalite

NON COMBUSTIBLE SYSTEM

*Non-Combustible EIFS Cladding
Pressure Moderated*

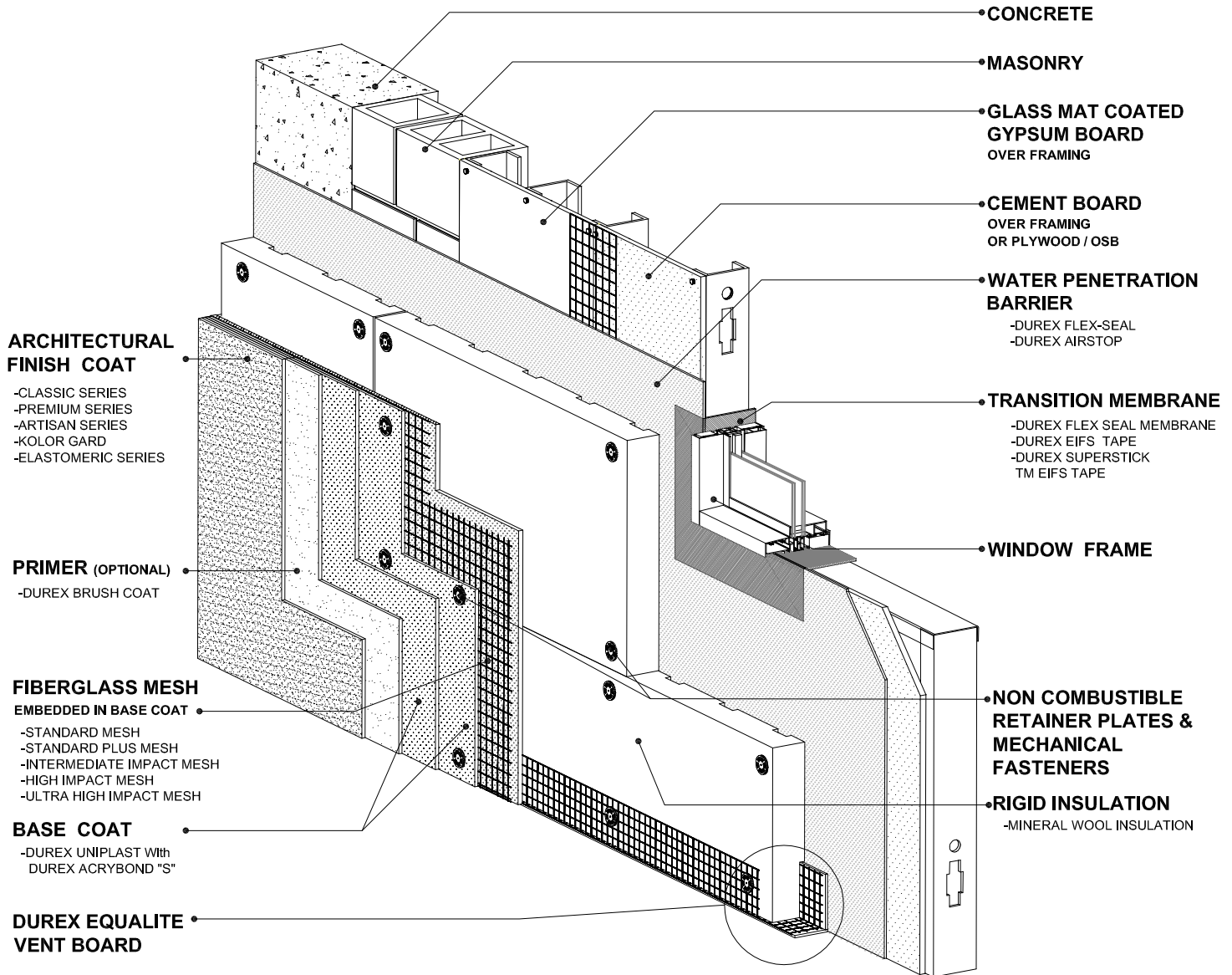

DURABOND

1-877-387-2266 - info@durabond.com - www.durabond.com

Durabond details are offered to assist in the development of project specific details; principles and variables incorporated in all details are the sole responsibility of the project professional(s).

*System Isometric
& Components*

PART 1: - GENERAL

1.1 GENERAL REQUIREMENTS

- .1 All conditions of the contract and Division 1, General Requirements apply to this section.
- .2 All work shall meet applicable codes and standards, the Occupation Health & Safety Act, manufacturer's recommendations and good building practice.
- .3 System Description: An exterior insulation and finish system based on flat mineral fiber insulation that includes a water resistive barrier that is applied to the substrate and which could serve as well as an air and/or air/vapour barrier. The exterior insulation and finish system is intended for use on buildings where the applicable Building Code requires the use of noncombustible claddings and noncombustible insulation.

SPEC NOTE: The Designer must decide whether the wall assembly of this structure requires an air barrier or an air/vapour barrier.

1.2 COORDINATION

- .1 Ensure that the work of this section is coordinated with the work of related sections.

1.3 RELATED SECTIONS

- | | | |
|-----|------------------|--------------------------------|
| .1 | Section 03 30 00 | Cast-in-Place Concrete |
| .2 | Section 04 20 00 | Unit Masonry |
| .3 | Section 05 41 00 | Structural Metal Stud Framing |
| .4 | Section 06 10 00 | Rough Carpentry |
| .5 | Section 07 20 00 | Thermal Protection |
| .6 | Section 07 26 00 | Vapour Retarders |
| .7 | Section 07 27 00 | Air Barrier |
| .8 | Section 07 62 00 | Flashing and Sheet Metal |
| .9 | Section 07 90 00 | Joint Protection (Sealants) |
| .10 | Section 08 00 00 | Openings |
| .11 | Section 08 50 00 | Windows |
| .12 | Section 09 28 00 | Backing Board and Underlayment |

1.4 REFERENCES

- .1 American Society for Testing Materials
 - .1 ASTM B117 Standard Practice for Operating Salt Spray (Fog) Apparatus.
 - .2 ASTM C612 Standard Specification for Mineral Fiber Block and Board Thermal Insulation.
 - .3 ASTM C1177/C1177M Standard Specification for Glass Mat Gypsum Substrate for Use as Sheathing.
 - .4 ASTM C1338 Standard Test Method for Determining the Fungi Resistance of Insulation Materials and Facings.
 - .5 ASTM C1382 Standard Test Method for Determining Tensile Adhesion Properties of Sealants When Used in Exterior Insulation

[PROJECT NO.]
[DATE]

[PROJECT NAME]
[PROJECT LOCATION]

- .6 ASTM C1397 and Finish Systems (EIFS) Joints.
Standard Practice for Application of Class PB Exterior Insulation and Finish System (EIFS) and EIFS with Drainage.
- .7 ASTM C1481 Standard Guide for Use of Joint Sealants with Exterior Insulation and Finish Systems (EIFS).
- .8 ASTM D1623 Standard Test Method for Tensile and Tensile Adhesion Properties of Rigid Cellular Plastics.
- .9 ASTM D5035 Standard Test Method for Breaking Force and Elongation of Textile Fabrics (Strip Method).
- .10 ASTM D5420 Standard Test Method for Impact Resistance of Flat, Rigid Plastic Specimen by Means of Striker Impacted by Falling Weight (Gardner Impact).
- .11 ASTM E84 Standard Test Method for Surface Burning Characteristics of Building Materials.
- .12 ASTM E96/E96M Standard Test Methods for Water Vapor Transmission of Materials.
- .13 ASTM E330 Standard Test Method for Structural Performance of Exterior Windows, Doors, Skylights and Curtain Walls by Uniform Static Air Pressure Difference.
- .14 ASTM E331 Standard Test Method for Water Penetration of Exterior Windows, Skylights, Doors, and Curtain Walls by Uniform Static Air Pressure Difference.
- .15 ASTM E1131 Standard Test Method for Compositional Analysis by Thermogravimetry.
- .16 ASTM E1252 Standard Practice for General Techniques for Obtaining Infrared Spectra for Qualitative Analysis.
- .17 ASTM E2098 Standard Test Method for Determining Tensile Breaking Strength of Glass Fiber Reinforcing mesh for Use in Class PB Exterior Insulation and Finish Systems (EIFS), after Exposure to a Sodium Hydroxide Solution.
- .18 ASTM E2178 Standard Test Method for Air Permeance of Building Materials.
- .19 ASTM E2357 Standard Test Method for Determining Air Leakage of Air Barrier Assemblies.
- .20 ASTM E2486 Standard Test Method for Impact Resistance of Class PB and PI Exterior Insulation and Finish Systems (EIFS)
- .21 ASTM F410 Standard Test Method for Wear Layer Thickness of Resilient Floor Coverings by Optical Measurement.
- .22 ASTM G154 Standard Practice for Operating Fluorescent Ultraviolet (UV) Lamp Apparatus for Exposure of Nonmetallic Materials.
- .23 ASTM G155-05a Standard Practice for Operating Xenon Arc Light Apparatus for Exposure of Non-Metallic Materials.
- .2 Canadian Construction Materials Centre (CCMC)
.1 CCMC Technical Guide for the Evaluation of EIFS MF # 07 24 13.01.
- .3 Canadian Standards Organization (CSA)
.1 CSA B111 Wire Nails, Spikes and Staples
.2 CSA O86 Engineering Design in Wood.
.3 CSA O325 Construction Sheathing.

[PROJECT NO.]
[DATE]

[PROJECT NAME]
[PROJECT LOCATION]

- .4 CSA 0121 Douglas Fir Plywood.
- .5 CSA 0151 Canadian Softwood Plywood.
- .6 CSA 0153 Poplar Plywood.

- .4 International Organization for Standardization (ISO)
 - .1 ISO 7892 Vertical building elements – Impact resistance tests – Impact bodies and general test procedures.
 - .2 ISO 7895 Façade made of components - Tests for resistance to positive and negative static pressure generated by wind.
 - .3 ISO 15148 Hygrothermal performance of building materials and products - Determination of water absorption coefficient by partial immersion.

- .5 ULC (Underwriters Laboratories of Canada)
 - .1 CAN/ULC-S101 Standard Methods of Fire Endurance Tests of Building Construction and Materials.
 - .2 CAN/ULC-S102 Standard Method of Test for Surface Burning Characteristics of Building Materials and Assemblies.
 - .3 CAN/ULC-S102.2 Standard Method of Test for Surface Burning Characteristics of Flooring, Floor Coverings, and Miscellaneous Materials and Assemblies.
 - .4 CAN/ULC-S114 Standard Method of Test for Determination of Non-Combustibility in Building Materials.
 - .5 CAN/ULC-S702 Standard for Mineral Fibre Thermal Insulation for Buildings.
 - .6 CAN/ULC S716.1 Standard for Exterior Insulation and Finish Systems (EIFS) – Materials and Systems.
 - .7 CAN/ULC-S716.2 Standard for Exterior Insulation and Finish Systems (EIFS) - Installation of EIFS Components and Water Resistive Barrier.
 - .8 CAN/ULC-S716.3 Standard for Exterior Insulation and Finish Systems (EIFS) - Design Application.

1.5 DESIGN CRITERIA

- .1 Structural Design
 - .1 Design professional shall design the back-up wall in full compliance with the requirements of the National Building Code (NBC) of Canada and/or applicable provincial or territorial building codes. Sufficient details on architectural plans and drawings shall demonstrate compliance to the NBC.

SPEC NOTE: When used over stud wall framing, the structural wall framing members shall be at a maximum spacing of 406 mm (16") o/c.

- .2 Supporting Substrate
 - .1 All substrates shall be flat and plumb within 2 mm/m (1/4" per 10'), as per ASTM C 1397.
 - .2 All substrates shall be free of surface contamination, including (but not limited to): dirt, form release agents, efflorescence, oil and chalkiness.
 - .3 All substrates shall be free of any loose materials and cracks greater than 1 mm (1/24") in width.

- .3 Mass Wall Substrates
 - .1 Mass wall substrates shall be cast-in-place concrete, concrete masonry units or brick.
 - .2 Cast-in-place, concrete masonry units or brick shall be at least 28 days old.
 - .3 Unit masonry and brick veneer shall have mortar joints struck flush or recessed.

- .4 Sheathing Substrates
 - .1 Apply the system to one of the following recommended substrate sheathings or substrate system or approved equivalent:
 - .1 Cementitious backer Board as per ASTM C1325.
 - .2 Glass-mat gypsum sheathing conforming to ASTM C1177/C1177M.
 - .3 OSB and/or plywood sheathing conforming to CSA O86. OSB conforming to CSA O325. Douglas fir Plywood conforming to CSA O121, Canadian Soft Plywood conforming to CSA O151 and Poplar Plywood conforming to CSA O153.

SPEC NOTE: Sheathing/substrate system type and condition shall be as approved by Durabond Products Ltd. Questionable substrates to be reviewed by Durabond Products Ltd. and/or the Designer.

- .2 Sheathing shall be designed with framing to resist applicable wind loads, with a maximum design deflection of substrate not to exceed L/240.

SPEC NOTE: Sheathing shall be of a structural grade when used in conjunction with framing members spaced at 600 mm (24") o/c.

- .3 Sheathing substrates shall be installed in accordance with the sheathing manufacturer's latest installation instructions and installed in general conformance with ASTM C1280. Sheathing joints shall be properly staggered. Vertical joints shall be offset by at least one framing member. Sheathing shall be:
 - .1 Minimum 11.1mm (7/16") and 12.7 mm (1/2") thick for OSB and plywood sheathing respectively.
 - .2 Minimum 12.7 mm (1/2") thick for glass-mat gypsum, cementitious and fibre cement boards.
 - .3 Continuously supported by framing.
 - .4 The sheathing shall be installed horizontally across framing when using wood sheathing.
 - .5 Having sheathing joints not exceeding 3.0 mm (1/8").
 - .6 Installed with corrosion resistance fasteners tight and flush to the sheathing surface (Not to be countersunk).
 - .7 Replaced where damaged or weathered.

- .5 Air/Vapour/Moisture Resistive Barrier
 - .1 The air/vapour/moisture control shall be designed using the specified, designated control membrane. Continuity of these membranes shall be maintained at all wall interfaces.
 - .2 The use, location and performance of the air barrier shall be determined by the design professional.
 - .3 The use and location of the vapour retarder within the wall assembly shall comply with the requirements of Part 5 of the National Building Code (NBC) of Canada and/or the applicable provincial or territorial building codes.

- .4 Water Resistive Barrier
 - .1 A ready-mix 1 or 2 components, polymer-based water resistive barrier which can be roll, spray or trowel-applied in a continuous layer over the substrate.
 - .2 A self-adhered, modified bituminous, composite, waterproof membrane, consisting of a styrene-butadiene-styrene (SBS) rubberized asphalt compound, which is integrally laminated to a woven polyethylene film on one side with a film-covered, adhesive undersurface on the reverse side.
 - .3 All sheathing and/or water damage susceptible substrates shall be protected with the specified Durex® water resistive barrier and as shown on the drawings.
 - .4 The designated water resistive barrier system shall include the specific sheathing joint transition membrane.
 - .5 The water resistive barrier shall be applied in conformance with the exterior insulation and finish system manufacturer's instructions.
 - .6 The continuity of water resistive barrier shall be maintained across windows, openings, joints and all other wall interfaces.
 - .7 The second plane of protection for moisture management shall be made using the specified exterior insulation and finish system's water resistive barrier and drained air space.
 - .8 The drained air space behind the insulation board, as provided by the GDDC insulation and/or the adhesive notched trowel shall remain unobstructed and shall terminate in such a way as not to obstruct the drainage of any incidental moisture to the exterior.

- .6 Air/Vapour/Moisture Transition Membrane
 - .1 The continuity of the air/vapour/moisture control elements shall be maintained across joints, windows, openings and all other wall interfaces using the specified transition membranes.
 - .2 Through wall penetrations and openings shall be sealed to the water resistive barrier with transition membranes.
 - .3 Transition membranes shall be installed at all movement joints, roof junctions and window and door interfaces.
 - .4 Transition membranes shall be installed in conformance with manufacturers' instructions.
 - .5 Transition membranes shall be as listed in Part 2, "Products" of this specification. No other generic transition membranes should be permitted.

SPEC NOTE: Allowance for use of generic transition membranes could result in membranes that may not be compatible with the exterior insulation and finish system's adhesives.

- .7 Insulation
 - .1 Taking into consideration the physical and mechanical properties of mineral fibre insulation, the minimum thickness of the GDDC mineral fibre insulation shall not be less than 76 mm (3.0").
 - .2 The design of the thermal resistance of the wall assembly must be in accordance with the requirements of Section 9.25, Heat Transfer, Air Leakage and Condensation Control of Division B of the NBC 2015 or the equivalent requirements of the related applicable provincial or territorial codes. The design of the of the inboard/outboard insulation of the wall assembly shall be in conformance with minimum ratio of outboard to inboard thermal resistance of Article 9.25.5.2 of Division B of the NBC 2015.

- .3 The design of the of the thermal resistance of the wall assembly must be in accordance with the requirements of the National Energy Code of Canada for Buildings (NECB) or the equivalent requirements of the related applicable provincial or territorial codes. The insulation type and thickness shall be designed with respect to the minimum effective thermal resistance and continuous insulation requirements of the NECB or the equivalent requirements of the related applicable provincial or territorial codes.
- .4 The exterior insulation and finish system can provide additional thermal insulation to the wall assembly with no detrimental effects if properly installed with knowledge of the existing wall configuration and performance.

SPEC NOTE: The thermal resistance requirements for the Effective Thermal Resistance (Eeff) and Continuous Insulation (CI) vary depending on building occupancy, climatic zone and structural substrate components. Consult the exterior insulation and finish system's manufacturer for assistance and recommendations on the thickness of insulation boards that would be required to meet the project's specific thermal energy requirements.

.8 Code-related Fire Protection

- .1 The exterior insulation and finish system is intended to be used in noncombustible constructions and/or in combustible constructions requiring non-combustible claddings, as allowed by the Code through conformance to Article 3.2.3.7. and Article 9.10.15.5. of Division B of the National Building Code (NBC) of Canada and/or the equivalent requirements of the related applicable provincial or territorial codes.

SPEC NOTE: Fire protection requirements are subject to provincial variations, refer to specific provincial fire protection code compliance requirements for specific allowances/limitations that may apply.

SPEC NOTE: Refer to manufacturer's fire protection code compliance report for specific limitations that may apply.

.9 Impact Resistance

- .1 Design professional shall design the building façade to the desired Impact Resistance Levels that could be expected at various sections of the façade.
- .2 The required impact resistance level may vary for various sections of the façade, based on the type, level and frequency of exposure to expected energy levels associated to impact loads.
- .3 Sufficient details on architectural plans and drawings shall demonstrate compliance to the required Impact Resistance Level of the exterior insulation and finish system.
- .4 Table 1.5.9 below shall be utilized to establish and specify the Impact Resistance Levels of the exterior insulation and finish system.

Table 1.5.9 – Impact Resistance in accordance with ASTM E 2486

| Impact Resistance Classification | Reinforcing Mesh ⁽¹⁾⁽³⁾⁽⁴⁾ | | | Impact Resistance | |
|---|---------------------------------------|------------------|---------------|---|--|
| | Layer 1 | Layer 2 | Layer 3 | Retention of Physical Properties (No Cracks / Damage) | Retention of Performance (No Breakage of Reinforcing Mesh) |
| Standard Impact Resistance ⁽²⁾ | Standard Mesh | n/a | n/a | 3 N.m | 10 N.m |
| Medium Impact Resistance | Intermediate Mesh | n/a | n/a | 8 N.m | 15 N.m |
| High Impact Resistance | Standard Mesh | Standard Mesh | n/a | 13 N.m | 20 N.m |
| Ultra High Impact Resistance | High Impact Mesh | Standard Mesh | n/a | 20 N.m | 30 N.m |
| Extreme Impact Resistance | High Impact Mesh | High Impact mesh | Standard Mesh | 25 N.m | 40 N.m |

(1) Each layer of reinforcing mesh shall be fully embedded in the base coat and allowed to individually cure.
(2) "Intermediate" is the minimum mesh grade that needs to be used in conjunction with mineral wool based EIFS. This is required to obtain the proper characteristics and surface finishing of the lamina. Standard mesh shall not be used with mineral wool based EIFS
(3) Refer to section 2.7 of this specification for reinforcing mesh details.
(4) Other combinations of reinforcing mesh layers may be utilized to achieve the desired Impact Resistance Level based on confirmed tested performance by accredited laboratory.

SPEC NOTE: Ultra High Impact Resistance shall be provided to a minimum height of 2.0 meters above finished grade and at all areas accessible to pedestrian traffic and/or exposed to abnormal impact loads. Refer to manufacturer's guidelines for the recommended Impact Resistance Levels relative to the building code occupancy classification.

.10 Design Details at Terminations

- .1 The exterior insulation and finish system shall extend a minimum of 25 mm (1") below the sill plate onto the foundation wall. The system shall terminate at least 200 mm (8") above finished grade.
- .2 The system shall not be used on wall surfaces subject to continuous or intermittent water immersion or hydrostatic pressure.
- .3 The system shall be terminated a minimum of 12.7 mm (1/2") from adjoining materials at interfaces for sealant applications.
- .4 Ensure the use of higher-grade glass reinforced mesh for higher impact resistance at locations indicated on architectural drawings.

- .11 Projections and Reveals
- .1 Ensure termination of the exterior insulation and finish system at roof parapet is covered with continuous waterproofing membrane and sheet metal cap that is coordinated with the roofing contractor.
 - .2 Conform with the following guidelines for length and slope of inclined surfaces:
 - .1 Minimum slope (6:12), for projection greater than 102 mm (4").
 - .2 Minimum slope (3:12), for projection less than 102 mm (4").
 - .3 The exterior insulation and finish system shall not be used for areas defined by codes as roofs.
 - .4 Conform with the following guidelines for minimum thickness of system's insulation when reveals form part of façade aesthetics:
 - .1 When three-dimensional architectural designs are desired by cutting into the insulation, a minimum thickness of 50 mm (1"), exclusive of the reveal depth, and/or any pattern or drainage grooves cut into the back of the insulation shall be maintained.

SPEC NOTE: The use of three-dimensional architectural designs by cutting into the insulation is a common practice and an ideal feature of the exterior insulation and finish system. When designing for such aesthetic reveals the overall thickness of the system's selected insulation shall be the greater of the "depth of reveal + 50 mm" and 76 mm. Thicker insulation can be used to accommodate deeper reveals.

- .12 Sealant System
- .1 Joints in exterior insulation and finish system shall be sealed using an elastomeric sealant with a closed-cell foam backer rod or bond breaker tape, as specified in Section 07 90 00 and as tested to ASTM C1382.
 - .2 Minimum joint width shall be four times greater than the anticipated range of movement. Sealant shall be applied in a width to depth ration of (4:1), (3:1), (2:1) as recommended by the Sealant manufacturer.
 - .3 Sealant installation shall conform with the requirements of ASTM C1481.

SPEC NOTE: Recommended joint width is 19 mm (3/4") for expansion joints, however, site and design conditions may require the nominal width to vary.

- .13 Expansion and Termination Joints
- .1 Provide two stage sealant joints at all expansion and termination joint locations. The inner joint seal is not required if the water resistive barrier system is continuous behind the outer joint seal and /or penetrations.
 - .2 Sealant Joint Venting
All two stage sealant joints shall be vented:
 - .1 Horizontal joints shall be vented at not greater than 1.2 m (4'-0") on center.
 - .2 Vertical joints shall be vented at not greater than 3 m (10'-0") on center and/or at not greater than 50 mm (2") below the intersection of vertical and horizontal joints.

SPEC NOTE: The designer shall determine the spacing and amount of drainage and/or venting required for a particular system. Note, the venting is only required at points where gravity-induced drainage is expected to occur, hence, roof parapets and/or the underside of window sill flashing would not require sealant vents.

- .3 Expansion joints are required at the following locations:
 - .1 At movement joint locations within the substrate.

- .2 At building movement joint locations.
- .3 At floor lines of all wood frame structures and as required by the structural design of other framing types.
- .4 At junctions with different cladding materials and components.
- .5 At changes in roof line, building shape or structural system.
- .6 At changes in substrate materials.
- .7 At all other locations specified or indicated on drawings
- .4 Termination joints are required at the following locations:
 - .1 At windows, doors and through-wall penetrations interfaces.
 - .2 200 mm (8") above finished grade.
 - .3 50 mm (2") above roofing system.
- .14 Flashing
 - .1 Provide corrosion-resistant flashing at all roof-wall intersections, windows and door heads and sills, decks, balconies, chimneys, parapet walls, projecting features and other areas as necessary to direct water to the exterior and to prevent water entry behind the cladding.
 - .2 Flashing must be installed in accordance with section 07 60 00 and the applicable building codes.
 - .3 Flashing shall have a slope of not less than 6% towards the exterior, lap not less than 10 mm (3/8") vertically over the building element below, terminate in a drip offset not less than 5 mm (3/16") outward from the outer face of the building and terminate at each end with an end-dam.
- .15 Finish
 - .1 The design professional shall assess the design of the building façade to the desired finish textures and colours that could be expected at various sections of the façade.
 - .2 Where the type of texture and the intensity of the selected colours include vibrant, accent and / or mass tone colours that are more susceptible to UV degradation, the designer shall specify the use of Durex Kolor Gard Architectural Coatings to augment and heighten the colour fastness.
 - .3 Sufficient details / notifications on architectural plans and drawings shall demonstrate the required specialized finish texture and colour of the exterior insulation and finish system.

1.6 SUBMITTALS

- .1 Product Data
 - .1 Submit the exterior insulation and finish system's specifications and individual component data sheets to show compliance to the intent of the design specifications, and installation instructions.
 - .2 Submit approvals and/or evaluations applicable to the system and/or components to be installed.
- .2 Shop Drawings
 - .1 Submit shop drawings in accordance with requirements specified in Division 1.
 - .2 Clearly indicate dimensions, tolerances and materials in large-scale details for terminations, drainage/venting, description of related and abutting components and elevations of units with locations of expansion joints, control joints, and reveals.

- .3 Samples
 - .1 Prior to application of mock-up, submit duplicate 150mm x 200mm (6" x 8") representative colour samples of each colour and finish coat texture.
 - .2 Maintain an approved sample at the project site.

- .4 Closeout Submittals
 - .1 Provide exterior insulation and finish system's maintenance, repair and cleaning procedures.
 - .2 Provide exterior insulation and finish system's material warranty as per section 1.10.
 - .3 Provide workmanship warranty by EIFS applicator as per section 1.10.
 - .4 Provide identification labels of colour batch numbers, water resistive barriers, adhesives, base coat, finish coats and reinforcing mesh used.

1.7 QUALITY ASSURANCE

- .1 Qualifications
 - .1 System Manufacturer: All system components shall be manufactured or sold by the exterior insulation and finish system's manufacturer and purchased from the system's manufacturer and/or its authorized distributors.
 - .2 Contractor: Shall be knowledgeable in the proper installation of the exterior insulation and finish system and shall be in possession of the system's current Certificate of Installer. Work of this specification shall be executed in conformance with CAN/ULC S716.2 and manufacturer's installation manual.
 - .3 Insulation Board Manufacturer: The insulation board manufacturer must be listed by exterior insulation and finish system and must provide insulation boards that are in full compliance with the applicable insulation standards.
 - .4 The EIFS manufacturer shall be a good-standing member of the EIFS Council of Canada.

- .2 Mock-Up
 - .1 The contractor shall, before installation works, provide the owner/consultant with a mock-up demonstrating the exterior insulation and finish system's components and methods of attachment.
 - .2 The Mock-up shall be constructed to dimensions and in location specified by the Designer.
 - .3 The mock-up system's component shall include the water resistive barrier, adhesive, insulation, reinforcing mesh, base coat and finish coats that would include each colour and texture to be used.
 - .4 The mock-up shall demonstrate methods of attachment as well as typical connections to opening (windows, doors etc.) and roofing assemblies.
 - .5 The Mock-up shall serve for initial review purposes by the Consultant and when accepted shall represent the minimum standard for work and the basis for acceptance for the rest of the project.
 - .6 The mock-up shall be prepared with the same products, components, tools and techniques required for the actual project.
 - .7 The approved mock-up shall be available at all time at the jobsite and shall form the basis for acceptance for the remainder of the project.
 - .8 Accepted mock-up may remain as part of the work.

1.8 DELIVERY, STORAGE, HANDLING & PROTECTION

- .1 All required materials and components shall be supplied by the manufacturer of the exterior insulation and finish system and shall be delivered to job site in original, unopened packaging with all identifying labels and markers clearly visible and intact. Upon delivery, materials shall be inspected for any damages and the system's manufacturer shall be advised, in writing of any damaged and/or unacceptable materials. Any defective materials and/or components shall not be used.
- .2 Materials shall be stored in a dry, vented, weatherproof enclosures, stacked off the ground, out of direct sunlight and other detrimental conditions. Pail products and liquid materials shall be stored at ambient temperatures above 5°C and below 35°C. All materials shall be protected from freezing or overheating.
- .3 Protective coverings shall be provided to all freshly-applied coatings to protect them from damages due to rain, inclement weather and/or any other damages until the coatings have fully set and cured.
- .4 All capping and flashing shall be immediately and properly installed in co-ordination with the application of the exterior insulation and finish system, unless temporary protection has been provided. If capping and flashing or temporary protection have not been provided, the Architect and General Contractor shall be advised accordingly in writing.
- .5 All insulation boards shall be protected from direct sunlight.

1.9 PROJECT/SITE CONDITIONS

- .1 Prior to installation of the exterior insulation and finish system, the substrate shall be examined with respect to the following:
 - .1 The substrate shall be type-approved by system's manufacturer.
 - .2 The substrate surface shall be free of any deleterious materials such as oil, dust, direct form-release agents, paint, wax glazing, water, moisture, efflorescence, frost, etc.
 - .3 The substrate shall be examined for soundness, such as tightness of connections, crumbling, spalling, delamination, voids, loose joints and projections.
 - .4 The substrate shall be examined for compliance with Contract Documents.
- .2 Ambient Conditions
 - .1 Application shall take place when ambient and substrate temperatures are within the specified limits by manufacturer and when the substrate is free from any moisture arising from condensation, frost, and/or rainfall.
 - .2 Do not proceed with application of materials immediately prior to, during, or immediately after inclement weather conditions, nor if adverse weather is anticipated within 24 hours after application.
 - .3 Do not apply materials to wet, frozen or frosted surfaces.
 - .4 Application of water resistive barrier, base coat and finish coat shall not proceed during rainy conditions or weather conditions with ambient air or wall surface temperatures below 5°C or above 38°C. Wet applied coatings shall be protected from rain until they are completely dry.
 - .5 Avoid coating surfaces that are directly exposed to direct sunlight or windy conditions.
 - .6 When necessary, provide temporary enclosures for exterior work and ensure

that temporary climatized enclosure is provided in the area of work to maintain the required ambient air temperature prior to, during application and for a minimum of 24 hours after application of coating.

SPEC NOTE: Carefully co-ordinate to determine whether or not the General Contractor is to provide temporary enclosure and heat.

- .7 Do not apply finish coat in areas where dust is being generated.
- .8 Proceed with work only when surfaces and conditions are satisfactory for the production of perfect application.
- .9 Protect applied coating from rapid evaporation during dry and hot weather.
- .10 Consult system's manufacturer for recommendations should adverse conditions exist.

1.10 WARRANTY

- .1 The warranty period stipulated in the General Conditions of the Contractor shall be extended as follows:
 - .1 The system is eligible for a manufacturer's warranty from the date of substantial completion, upon written request, against defective material. For full applicable warranty details contact the system manufacturer.
 - .2 The manufacturer warranty is effective only when materials and workmanship comply with this specification.
 - .3 The system manufacturer does not warrant workmanship.
 - .4 The system applicator shall warrant workmanship separately against faulty workmanship.

SPEC NOTE: Substitution of materials and/or components specified in this specification shall void the manufacturer's warranty.

PART 2: - PRODUCTS

2.0 MANUFACTURER

- .1 All components of the Durex® "Equalite" system shall be manufactured and/or distributed by Durabond Products Ltd. or one of its authorized distributors. No substitutes of materials shall be allowed without prior written notice of the manufacturer.

2.1 WATER RESISTIVE BARRIER (WRB)

- .1 Durex® Flexseal Membrane, a self-adhered, modified bituminous membrane, consisting of a styrene-butadiene-styrene (SBS) rubberized asphalt compound which is integrally laminated to a tri-laminated woven polyethylene film on one side with a silicone-treated release backing on the reverse side. The membrane has a minimum thickness of 1 mm (40 mil) and available in rolls 910 mm (36"), 450 mm (18"), 300 mm (12"), 225 mm (9"), 150 mm (6"), 100 mm (4") wide and 22.9 m (75') long.
- .2 Durex® Flexseal Membrane VP, a self-adhered, vapour permeable, modified bituminous membrane, consisting of a styrene-butadiene-styrene (SBS) rubberized asphalt compound which is integrally laminated to a woven polyethylene film on one side with a silicone-treated release backing on the reverse side. The membrane has a

minimum thickness of 0.6 mm (24 mil) and available in rolls 950 mm (37"), 300 mm (12"), 230 mm (9"), 150 mm (6") wide and 30 m (98.4') long.

- .3 Durex® AirStop, a ready to use, single component, silicone modified acrylic copolymer WRB/Air barrier.

SPEC NOTE: All Durex® Flexseal Membrane side and end lap joints shall overlap a minimum of 50 mm (2"), while Durex® Flexseal Membrane VP side lap joints shall overlap a minimum of 50 mm (2") and end lap joints a minimum of 75 mm (3").

SPEC NOTE: Durex® Flexseal Membrane and Durex® Flexseal Membrane VP shall be installed in a single overlap formation to provide a continuous moisture barrier to flash out any incidental water intrusion.

SPEC NOTE: The water resistive barrier system may also be designed to act as the wall assembly air barrier and/or vapour barrier material as determined by the consultant of the wall assembly.

2.2 SHEATHING JOINT REINFORCING

SPEC NOTE: When Durex® Flexseal Membrane and Durex® Flexseal Membrane VP are used continuously over the field of the wall, no additional joint treatment in the substrates is required.

2.3 TRANSITION MEMBRANE

- .1 Durex® EIFS Tape, a 30 mil thick, self-adhering, Styrene Butadiene Styrene (SBS) modified rubberized asphalt membrane with a polyester top surface. Available in rolls 914 mm (36"), 457 mm (18"), 225 mm (9"), 152 mm (6") and 102 mm (4") wide. Durex® EIFS Tape requires the use of Durex® Flex-Seal Primer for proper adhesion.
- .2 Durex® EIFS Tape Super Stick TM, a 17 mil, self-adhering, high performance tape with a polyester fabric top layer. Available in rolls 914 mm (36"), 457 mm (18"), 225 mm (9"), 152 mm (6") and 102 mm (4") wide. Durex® Super Stick TM requires the use of Durex® Flex-Seal primer for proper adhesion.
- .3 Durex® Flex-Seal Membrane, a 40 mil thick, self-adhering, rubberized asphalt membrane with high density cross-laminated polyethylene reinforcement. Available in rolls 914 mm (36"), 457 mm (18"), 225 mm (9"), 152 mm (6") and 102 mm (4") wide. Durex® Flex-Seal Membrane requires the use of Durex® Flex-Seal Primer.

SPEC NOTE: Durex® Flex-Seal Primer, a primer specifically designed to enhance the adhesion of Durex® Flex-Seal Membrane and Durex® EIFS Tape on porous surfaces and cementitious coatings at temperatures above -30°C. It is composed of SBS synthetic rubbers, adhesive enhancing resins and volatile solvents. Durex® Flex-Seal Primer can be used on exterior gypsum boards, wood, metal and concrete.

2.4 INSULATION ATTACHEMENT

- .1 Mechanical fasteners for concrete, masonry, wood or steel studs framing, supplied by

Durabond Products Limited shall be corrosion resistant, coated in conformance with ASTM C1002, ASTM C954 and/or ASTM A548.

- .2 Fasteners shall be sized to be embedded into the substrate a minimum of 25 mm (1") for masonry substrates, 19 mm (3/4") for wood stud framing and substrates, and 9 mm (3/8") for steel stud framing with a minimum of 3 threads protruding through the steel member.
- .3 Fasteners plates supplied by Durabond Products Limited shall be Durex® Equalite noncombustible plates.

SPEC NOTE: Refer to fastener manufacturer's literature for fastener type, minimum penetration, and fastener pull-out resistance relative to design wind pressures.

- .4 Substitution of retainer plates shall not be permitted.

SPEC NOTE: Substitution of retainer plates shall not be permitted.

2.5 INSULATION

- .1 Durex® Equalite Board: A noncombustible, flat, non-grooved, mineral wool fibre insulation board made from basalt rock and slag, conforming to CAN/ULC S702 and ASTM C 612 Type IVB, measuring 1.2 m (4'-0") by 0.6 m (2'-0"), minimum density of 128 kg/m³ (8 lbs/ft³), minimum thickness of 76 mm (3.0"). The recommended total thickness of the board shall not be greater than 127 mm (5").
- .2 Durex® Equalite Board shall be noncombustible mineral wool fibre insulation board in conformance with CAN/ULC S114 and ASTM E84.

SPEC NOTE: Thicker or thinner insulation thicknesses could be used depending on specific project's requirements. Consult manufacturer for project-specific thickness requirements.

- .3 Durex® Equalite Vent Board: A mineral wool fibre insulation board conforming to CAN/ULC S702, measuring 200 mm (8") wide by 1.2 m (4'-0") long with a minimum thickness of 76 mm (3.0") and a recommended minimum thickness of 75 mm (3"). The Durex® Equalite Vent Board is pre-machined with rectangular, vertical drainage channels parallel to the short edge of the board, 50 mm wide, 50 mm apart and not less than 10mm (3/8") deep or as required by the project specifications or the drawings. Durex® Equalite Vent Board is supplied complete with pre-back-wrapped, factory applied base coat and reinforcing mesh.

SPEC NOTE: Durex® Equalite Vent Board is intended to be used in conjunction with Durex® Equalite Board at all horizontal terminations.

- .4 Durex® Equalite Boundary Board: A flat, mineral wool fibre insulation board, conforming to CAN/ULC S702, measuring 200 mm (8") wide by 1.2 m (4'-0") long with a minimum thickness of 76 mm (3") and a recommended minimum thickness of 75 mm (3"). The Durex® Equalite Boundary Board is pre-back wrapped with factory applied base coat and reinforcing mesh.

SPEC NOTE: Durex® Equalite Vent Board and Durex® Equalite Boundary Board have the same fire resistance characteristics as the Durex® Equalite Board.

2.6 REINFORCING MESH

- .1 Durex® Adhesive Detail Mesh. A nominal 152 g/m² (4.5 oz/yd²), flexible, open-weave, alkaline-resistant glass-fibre adhesive mesh, supplied in 241 mm (9.5") wide by 45.7 m (150') long rolls. Used for corner reinforcement and aesthetic detailing applications.
- .2 Durex® Intermediate Mesh (6.0 oz): A nominal 203 g/m² (6.0 oz/yd²), flexible, open-weave, alkaline-resistant glass-fibre adhesive mesh, supplied in 965 mm (38") wide by 45.7 m (150') long rolls. Used for application over the field of the wall, providing a moderately high-duty impact resistance.
- .3 Durex® Intermediate Plus Mesh (11.0 oz): A nominal 373 g/m² (11.0 oz/yd²), flexible, open-weave, alkaline-resistant glass-fibre adhesive mesh, supplied in 965 mm (38") wide by 22.8 m (75') long rolls. Used for application over the field of the wall, providing an intermediate high-duty impact resistance.
- .4 Durex® High Impact mesh (15.0 oz): A nominal 509 g/m² (15.0 oz/yd²), flexible, open-weave, alkaline resistant glass fibre adhesive mesh, supplied in 965 mm (38") wide by 22.8 m (75') long rolls. Used for application over the field of the wall, providing a high-duty impact resistance.
- .5 Durex® Ultra Impact mesh (21.0 oz): A nominal 695 g/m² (21.0 oz/yd²), flexible, open-weave, alkaline-resistant glass-fibre adhesive mesh, supplied in 965 mm (38") wide by 22.8 m (75') long rolls. Used for application over the field of the wall, providing an ultra-high-duty impact resistance.

SPEC NOTE: All areas requiring Impact Resistance Levels higher than "standard", as defined by Table 1.5.8 of this specification, shall be detailed in the project architectural drawings and shop drawings where applicable and described in the contract documents clearly identifying the Impact Resistance Classification, inclusive of the specific layers of reinforcing mesh applicable.

SPEC NOTE: The glass fibre reinforcing mesh plays an important role in the wind load resistance of mechanically attached EIFS. Accordingly, a minimum 203 g/m² (6.0 oz/yd²) provides the validated wind load resistance.

2.7 BASE COAT

- .1 Durex® Uniplast, a noncombustible, two components polymer-modified cementitious base coat mixed with Acrybond S, a water-based, 100% acrylic polymer additive at a ratio of 1 bag Durex® Uniplast to 5 liters of Durex® Acrybond S.

SPEC NOTE: Consult your Durabond Products Ltd. For further assistance in the selection of the appropriate base coat.

2.8 PRIMER

- .1 Durex® Brush Coat Primer, a water-based, 100% acrylic coating, colour-tinted to suit the colour of the final finish coat.

SPEC NOTE: Except for special finishes, the Primer is an optional component of the EIFS where its usage is recommended for providing uniform substrate absorption and finish colour.

2.9 FINISH COAT

- .1 Durex® Architectural Coatings, Classic Series, a 100% acrylic, water-based, multi-coloured, textured, protective coating. (Colour and texture to be selected)
- .2 Durex® Architectural Coatings, Premium Series, high build, multi-coloured, protective and decorative coating consisting of coloured quartz aggregates and oversized mica flakes embedded in a clear 100% acrylic resin, textured, protective coating. (Colour and texture to be selected)
- .3 Durex® Architectural Series, Artisan Series, a 100% acrylic, water-based, high-build, multi-coloured, textured with special patterns and artistic reliefs, protective coating. (Colour, texture and finish pattern to be selected)
- .4 Durex® Architectural Series, Kolor Gard Series, a 100% acrylic, Fade Resistant Decorative High Build Protective Textured Coating for Accent & Bright Colours. (Colour, texture and finish pattern to be selected)
- .5 Durex® Architectural Coatings, Elastomeric FX Series, a 100% acrylic, water-based, high-build, high flexibility, multi-coloured, textured, protective coating. (Colour and texture to be selected)

SPEC NOTE: In cases where the selected colours of the finish texture are of a vibrant accent and/or mass tone nature (Colours that require organic pigments in order to attain and retain the colour intensity), the designer is encouraged to consider specifying, exclusively, the use of Durex® Kolor Gard Series Coatings to augment and heighten the colour fastness of bright and mass tone coloured finishes. This engineered augmented UV fade resistance is limited to the Kolor Gard line of finishes that may result in additional application requirements that should be considered prior to tender.

2.10 TRIM ACCESSORIES

- .1 As selected by the Consultant and recommended by Durabond Products Ltd.

2.11 ACCESSORY PRODUCTS

- .1 Sealant: a low modulus sealant, as recommended and approved by Durabond Products Ltd. Standard colour shall be selected by consultant.
- .2 Foamed-in-place Insulation: Class 1, single or two components, polyurethane foam, moisture cured with flame-spread rating of ≤ 25 , fuel contribution 0 and smoke developed ≤ 20 , as per (ULC S710.1). Must be ozone friendly and containing no fluorocarbons and have a density $\geq 27.2 \text{ kg/m}^3$ (1.75 lb/ft³) and a minimum "RSI" value of 0.91 per 25 mm ("R" value of 5 per inch) thickness.

2.12 EQUIPMENT

- .1 All mixing shall be carried out with a clean, rust-free paddle mixer that shall minimize air entrainment, powered by a power-drill at 400-500 rpm maximum speed.
- .2 Sharp cutting knife or blades and appropriately sized sleds
- .3 Metal trowels, corner trowels, featheredge/darby, edge tool, hawks, utility knives, and plastic floats

PART 3: - EXECUTION

3.1 EXAMINATION

- .1 Examine surfaces to receive the exterior insulation and finish system for defects that could adversely affect execution and quality of work.
- .2 Ensure substrate surfaces, including each applied base coat, are dry, solid and sound, free of weak and powdery surfaces, free from ice, snow and frost, oil, grease, releasing agents and other deleterious materials detrimental to a positive bond.

SPEC NOTE: Deteriorating, weak, powdering or flaking surfaces may require further preparation work prior to installation of the exterior insulation and finish system. Check with the system's manufacturer for questionable substrate materials and conditions.

- .3 Ensure substrate tolerance is within 2 mm/m (0.25"/10').
- .4 Ensure that flashing at all openings, roof-wall intersections, terminations and other areas as required, have been installed to divert water away from the exterior insulation and finish system.
- .5 Report in writing to Consultant all adverse conditions which will be detrimental to work of this Trade.
- .6 Do not start work until all unsatisfactory conditions have been corrected.
- .7 Commencement of work shall indicate acceptance of substrate conditions.

3.2 PREPARATION

- .1 Prepare substrates to receive the exterior insulation and finish system as recommended in manufacturer's instructions.
- .2 Thoroughly clean and wash (existing) surfaces, including each applied base coat, (and including existing coated surfaces) by wire brushing or other approved methods to remove all dirt, dust, grease, oil, latent, efflorescence, loose coatings and any other deleterious materials.
- .3 Where necessary, mask all surrounding surfaces to provide neat, clean, true juncture lines with no over-spray of the coatings on surrounding surfaces.
- .4 Co-operate and co-ordinate with other trades penetrating or abutting to the work of

this Trade. Ensure that components by other trades are in position before the application of the exterior insulation and finish system.

3.3 APPLICATION

- .1 General:
 - .1 Supply experienced and qualified installers and applicators to carry out the work.
 - .2 Mix materials in accordance with manufacturer's instructions.
 - .3 Install the exterior insulation and finish system in strict accordance with the approved mock-up and manufacturer's printed instructions (and reviewed shop drawings).

SPEC NOTE: Correlate requirements for shop drawings with Article 1.6.

- .2 Water Resistive Barrier (WRB)
 - .1 Apply the selected insulation and finish system's water resistive barrier as per the manufacturer's application instructions.
 - .2 Prime substrate surfaces and install the self-adhering membrane over the entire surface of the substrate.
 - .3 Install the water resistive barrier in an overlapping shingle pattern to ensure water not getting behind the membrane.
 - .4 Roll the installed self-adhered membrane to ensure positive contact to the primed surfaces.
 - .5 Apply the exterior insulation and finish system's moisture transition membrane at all openings, fenestration and interfaces to maintain the continuity of the water resistive barrier at these locations.
 - .6 Tie-in the specified water resistive transition membranes to window frames, door frames, spandrel panels, roofing system and at interfaces of dissimilar materials as indicated in drawings.

SPEC NOTE: Refer to manufacturer's standard details.

- .7 Extend the water resistive membrane beyond the limits of the exterior insulation and finish system not less than 100 mm (4") and seal termination interface. Coordinate end-damming of drainage cavity at interface with other cladding types.

SPEC NOTE: Correlate requirements with shop drawings as per Article 1.10. Coordinate with trades responsible for the placement and installation of framing materials for wall openings such as window, door frames, louvers, and other mechanical penetrations.

- .3 Insulation Board
 - .1 Install full size exterior insulation and finish system's insulation board over the water resistive barrier membrane with the specified mechanical fasteners, beginning at one end to form an uninterrupted thermal barrier. Coordinate placement of the insulation boards with the system's pre-wrapped Vent board and Boundary board.
 - .2 Using full insulation boards only, install the insulation boards over the substrate with the long fibres vertical, in a running bond pattern and interlocking board

- joints at all corners.
- .3 Butt the insulation boards to a moderately tight fit, avoiding gaps between the boards. Fill any incidental gap with pieces cut to fit.
 - .4 Offset the running insulation boards a minimum of 200 mm (8") from sheathing joints.
 - .5 Organize board placement to align vertical edges with framing members or appropriate support system.
 - .6 Install insulation boards in an "L-shape" around fenestration and openings to avoid alignment of insulation joints with corners of openings.
 - .7 Mark out alignment and cut reveals in insulation boards as per architectural drawings. Ensure reveals are true to size, straight, plumb and level throughout.
- .4 Vent Board
- .1 Install the pre-wrapped exterior insulation and finish system's Vent Board at all heads of openings such as windows, doors, louvers etc., at the bases of the walls and at all horizontal interfaces/terminations between the exterior insulation and finish system and other cladding systems such as brick, stone, metal cladding, precast, metal flashing etc. Install the Vent Board by applying the specified fasteners. Allow an approximate 12.7 mm (1/2") space between the exterior insulation and finish system and the specified cladding system.

SPEC NOTE: Lap the reinforcing mesh of the Vent Board onto the front face of the insulation board by 100 mm (4"). Press the fabric of the Vent Board into a bed of base coat and smooth out ensuring that the reinforcing mesh is well embedded into the base coat.

- .5 Boundary Board
- .1 Install the Boundary Board, with long fibres vertical, at the top of the wall and at all vertical interfaces with dissimilar substrates, jambs and sills of fenestrations, at minor penetrations and other terminations by using the specified mechanical fasteners:

SPEC NOTE: Lap the reinforcing mesh of the Boundary Board onto the front face of the insulation board by 100 mm (4"). Press the fabric of the Boundary Board into a bed of base coat and smooth out ensuring that the reinforcing mesh is well embedded into the base coat.

SPEC NOTE: The Boundary Board should only be placed at the head of horizontal applications and not at the base.

- .6 Insulation Fasteners
- .1 Install the exterior insulation and finish system's insulation boards with mechanical fasteners and anchor plate washers specified by the manufacturer.
 - .2 The insulation boards shall be fastened by applying uniform pressure at all fasteners. Install the fasteners with the anchor plates/washers flush and slightly recessed below the surface of the insulation board. Do not remove any fasteners once they have been installed.
 - .3 The mechanical fasteners shall be applied in a two-stage application into the structural substrate and/or framing members.
 - .4 Secure the insulation boards to the substrate using 4 fasteners per 600 x 1200

- mm (2' x 4') board, followed by the application of the base coat and reinforcing glass fibre mesh over the insulation board.
- .5 Once the first application of the base coat has cured, apply the second stage of fasteners through the cured base coat into the framing members.
 - .6 Ensure that the second stage fasteners are aligned with the structural framing members at a maximum vertical and horizontal spacing of 406 mm (16") o/c. both horizontally and vertically.
 - .7 When anchoring into masonry or concrete substrates, use only the bits supplied with the fasteners for the attachment of the insulation board. Pre-drill holes to a minimum depth of 25 mm (1") deeper than the length of the fastener.
 - .8 Install fasteners within 100 mm (4") of the pre-back-wrapped Boundary and Vent boards with a spacing not exceeding 200 mm (8") o/c.

SPEC NOTE: The insulation thickness and the fastener pattern determine the related wind load resistance levels. Refer to the sketches herein for fasteners spacing requirements.

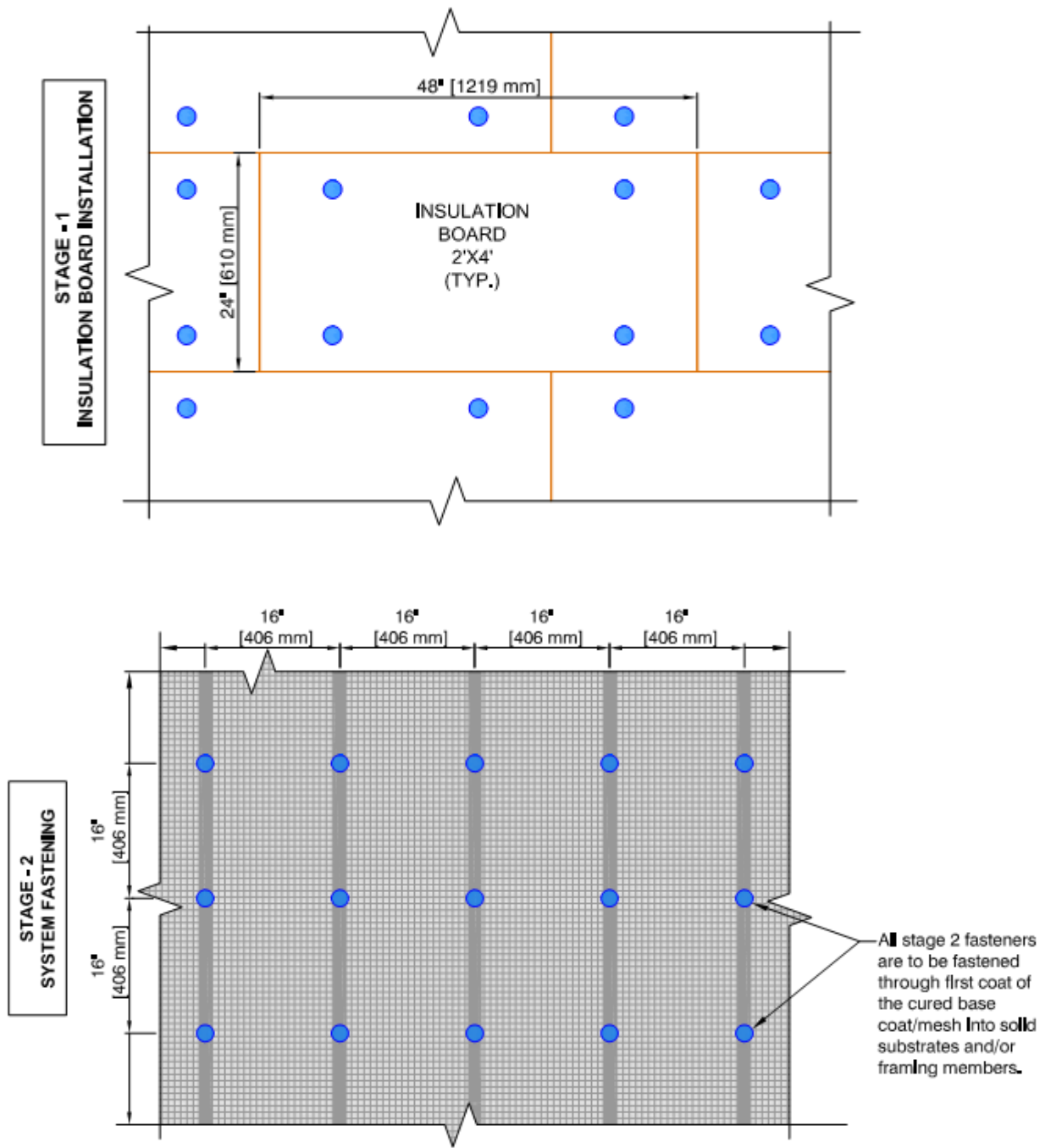

SPEC NOTE: The above fastening pattern addresses recommended fastener placement for typical wall installations. Consult Durabond Building Products Ltd. for project-specific installations.

- .7 Base Coat and Reinforcing Mesh
 - .1 Ensure that the surface of the insulation boards is dry and free of loose insulation, dirt, planar irregularities, etc. and that detail work has been completed.
 - .2 At all areas where detail reinforcing mesh has been installed, apply a layer of

- base coat to the exposed edges and face of the insulation boards. Pull the detail reinforcing mesh into the base coat so that it is fully embedded. Using an edging tool, smooth the corner to render it square.
- .3 Reinforce all corners of openings where no control joints are detailed with an additional strip of detail reinforcing mesh, 230 mm by 305 mm (9" by 12") installed diagonally across the corners.
 - .4 Apply a layer of base coat over the insulation surface, not less than 2 mm, applying sufficient pressure in the trowelling process to ensure full contact with the insulation. Immediately place the reinforcing mesh onto the wet base coat and trowel the mesh from the centre to the edges, filling all voids in the mesh until the mesh is completely embedded.
 - .5 Provide high impact reinforcing mesh where indicated on drawings. Tightly abut the edges; do not lap high impact mesh. Embed the mesh into the wet base coat and trowel the mesh from the centre to the edges, filling all voids in the mesh until the mesh is completely embedded. Allow the high impact mesh-reinforced base coat to dry before applying the successive reinforcing mesh.
 - .6 When applying additional layer of reinforcing mesh for higher impact resistance, each layer of the reinforcing mesh shall be fully embedded in the base coat and the first layer shall be allowed to dry before applying the second layer.
 - .7 Install the reinforcing mesh tight, straight and free of wrinkles, ripples and waves.
 - .8 Embed the intermediate reinforcing mesh into the base coat, over the entire surface of the dry, embedded high impact mesh, with joints overlapped a minimum of 102 mm (4") and double wrapping inside and outside corners a minimum of 203 mm (8").
 - .9 Overlap detail reinforcing mesh with intermediate reinforcing mesh 100 mm (4") at all locations where detail reinforcing mesh has been installed.

SPEC NOTE: When applying high impact reinforcing meshes, do not overlap high impact mesh, the joints between meshes shall just be tightly butted.

SPEC NOTE: The required backwrap of the insulation boards shall be made with the intermediate mesh only. Do not backwrap high impact reinforcing meshes.

- .8 Final Base Coat
 - .1 In hot, dry weather, if the scratch coat surface is exceptionally dry, lightly dampen the surface with a fog mist of clean potable water. Do not oversaturate with water, as it will impair the bonding of the base coat.
 - .2 Trowel apply the base coat, applying sufficient pressure to ensure full bond with the base coat.
 - .3 Use a straight edge tool to featheredge the surface and bring it to a straight, even and true surface.
 - .4 Total thickness of base coat shall be achieved at an application rate not less than 7.2 kg/m² (1.5 lb/ft²).
 - .5 When the base coat has taken initial set, use a wood or sponge float and work the surface with light circular motions to remove all high points and to fill low points.
 - .6 Final surface shall be smooth, straight and true to a tolerance of not more than

- 3.2 mm in 3 m (1/8" in 10'-0"). Surface shall be free of trowel marks, irregularities and visible mesh pattern.
- .7 Allow a minimum of 3 days for curing and drying.

SPEC NOTE: Do not over-saturate with water as it will impair the bonding of the base coat.

SPEC NOTE: The use of a straight edge tool to darby the base coat is essential and required to obtain a straight, even and true surface of the base coat.

- .9 Finish Coat Primer
- .1 Evenly apply the primer throughout with a high pile roller at a rate of 2.8 m²/l (600 ft²/pail). The substrate shall not be visible through the applied primer.
 - .2 Avoid excessive build-up in any one area.
 - .3 Allow minimum 4 hours for curing prior to application of finish coat.
- .10 Finish Coat
- .1 Apply the System's selected finish coat, within 3 days after application of the system's selected primer. Longer periods may be scheduled between operations provided that the primed surface is kept clean and in good condition.
 - .2 Apply the selected finish coat in strict accordance with manufacturer's printed instructions for the Selected finish.
 - .3 Apply the finish coat in such a way as to match the colour and texture of the approved site mock-up.
 - .4 Do not apply the finish coat onto surfaces that are intended to be caulked.

SPEC NOTE: In cases where the selected colour of the finish texture is of a vibrant, accent and/or mass tone nature for which Durex® Kolor Gard Series have been specified, the applicator shall ensure that the products and their respective application procedures are followed and no substitutions are made in product and/or in application. The engineered augmented UV fade resistance is limited to the Durex® Kolor Gard line of finishes that may result in additional application requirements that should be considered prior to tender.

3.4 JOINTS

- .1 Provide expansion joints in alignment with building expansion joints.
- .2 Install expansion joints at all locations where dissimilar substrates meet.
- .3 Install expansion joints at all locations of maximum stress, in the direction as shown on drawings.
- .4 Install control joints and/or reveals horizontally and vertically so to divide the wall surface into panels of not more than 20 m² (215 ft²). Neither dimension within the panel should be greater than 2.5 times the other.
- .5 All horizontal joints shall be vented by means of the manufacturer's Vent Board and located and spaced at intervals not greater than three stories.

- .6 Unless otherwise noted, provide all joints 12.7 mm (1/2") wide.

SPEC NOTE: As a rule of thumb, fulfill requirements 1 and 2 and then arrange the other requirements to best suit the intended aesthetics of the building.

3.5 SEALANTS

- .1 Seal and caulk all joints in the exterior insulation and finish system with the system's specified elastomeric sealant that shall be applied over a compatible closed-cell foam backer rod or bond breaker tape.
- .2 Seal and caulk all expansion joints between the exterior insulation and finish system and dissimilar abutting building components.
- .3 Apply sealant and/or sealant primer in strict accordance with the sealant manufacturers printed instructions.

SPEC NOTE: Apply sealant and/or sealant primer to base coat only.

3.6 SPECIAL CLEANING

- .1 Clean off all surfaces and work area of foreign materials resulting from material installation and leave work in clean condition.
- .2 Entirely reinstate at this Trade's own expense, any surface not to be coated, but soiled and attributable to this Trade due to spillage, mixing of material or any other cause.

3.7 PROTECTION

- .1 Protect the installed exterior insulation and finish system from damage during construction.
- .2 Provide protection of installed materials from precipitation, freezing, excessive heat, dust, and dirt during installation and curing of the system.
- .3 Provide protection to adjacent materials that could be damaged by the system's installation.
- .4 Post appropriate warning signs while work is in progress and during curing period.
- .5 Clean off all surfaces and work area of foreign materials resulting from material installation and leave work in clean condition.

END OF SECTION

OUTSIDE CORNER DETAIL

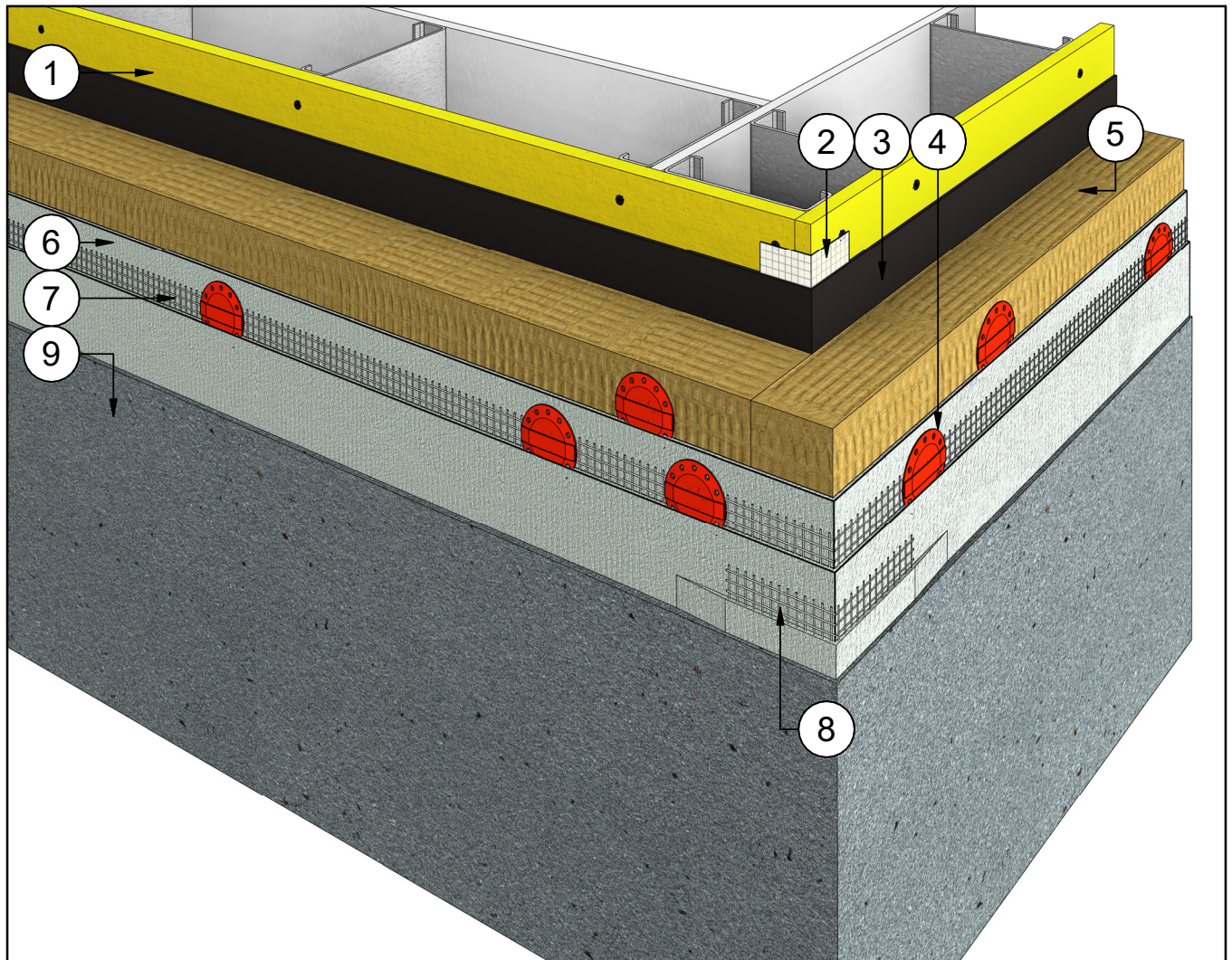

Note Text

- 1 Steel Studs Frame & Sheathing
- 2 Barrier Seam Tap (Embedded in WRB.)
- 3 WRB - Water Resistant Barrier
- 4 Insulation Fastner w/ Plate
- 5 Equalite Insulation Board
- 6 Base Coat
- 7 Fibreglass Reinforcing Mesh (Embedded in WRB)
- 8 Fibreglass Corner Mesh (Embedded in WRB)
- 9 Finish Coat



Durabond details are offered to assist in the development of project specific details; principles and variables incorporated in all details are the sole responsibility of the project professional(s).

OUTSIDE CORNER DETAIL

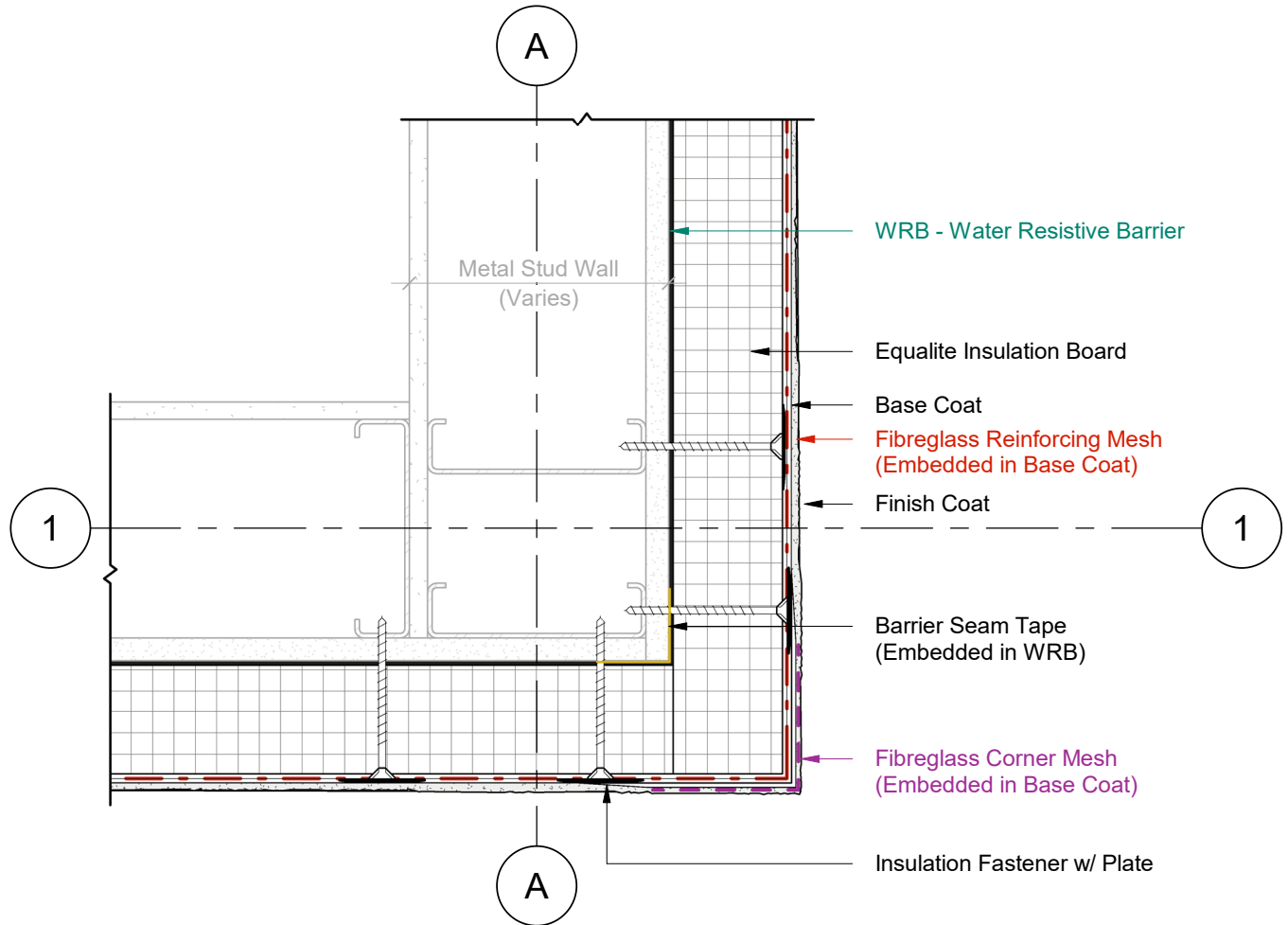

1 Plan Detail
2 Scale = 1:5

INSIDE CORNER DETAIL

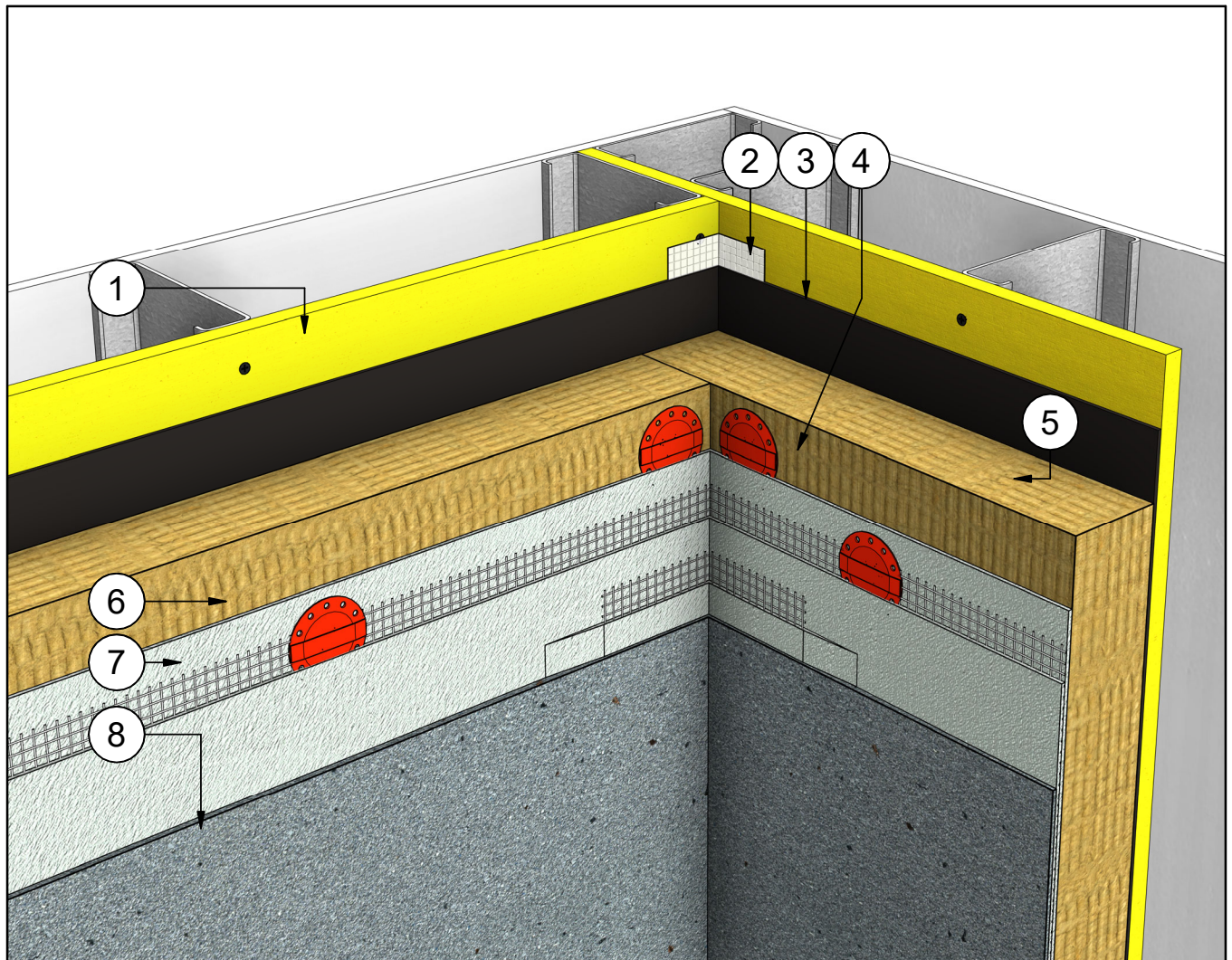

Note Text

- 1 Steel Studs Frame & Sheathing
- 2 Barrier Seam Tap (Embedded in WRB.)
- 3 WRB - Water Resistive Barrier
- 4 Fire Rated INSulation Fastener
- 5 Equalite Insulation Board
- 6 Base Coat
- 7 Fibreglass Reinforcing Mesh (Embedded in WRB)
- 8 Finish Coat



Durabond details are offered to assist in the development of project specific details; principles and variables incorporated in all details are the sole responsibility of the project professional(s).

INSIDE CORNER DETAIL

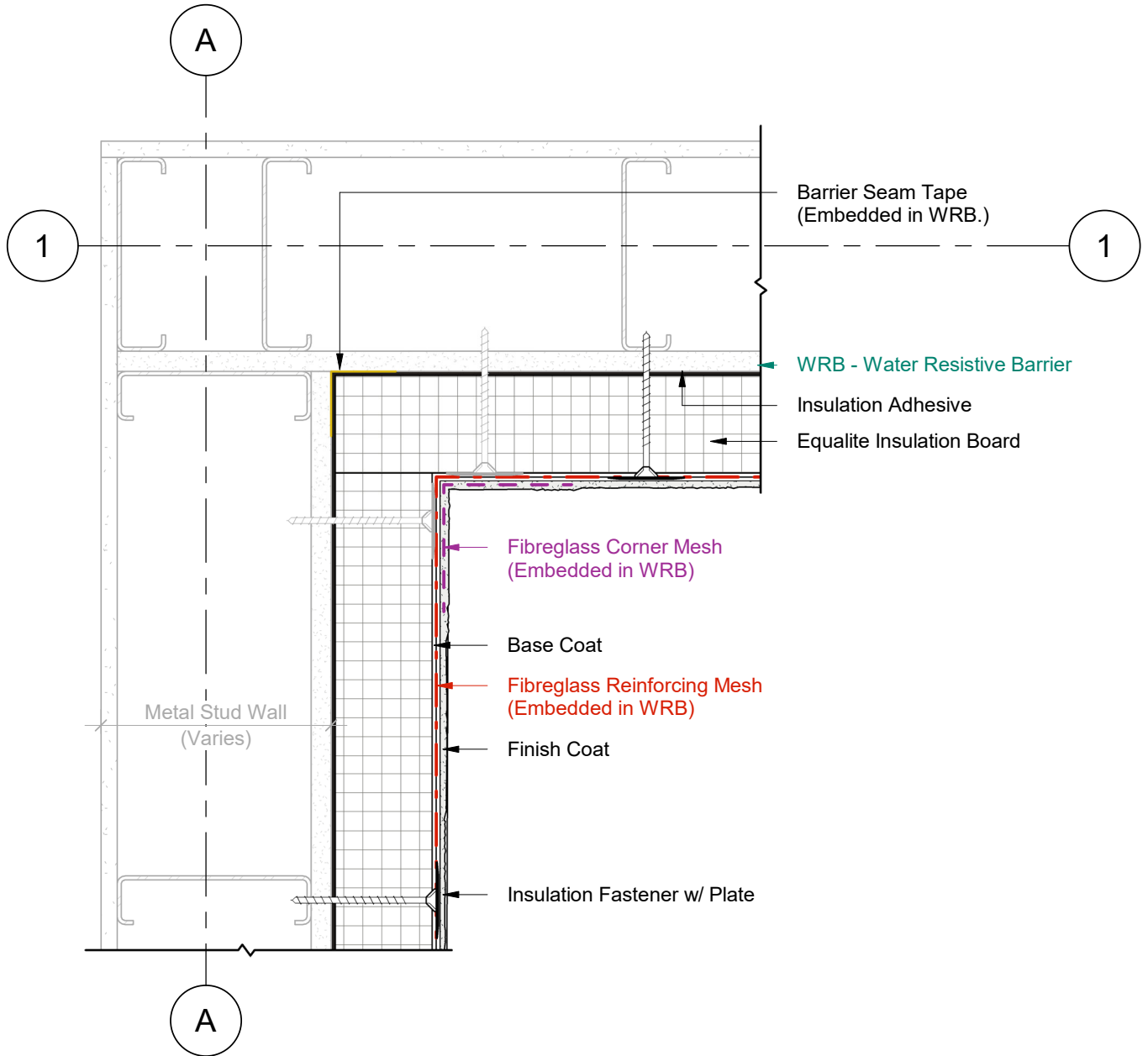

1 Plan Detail
2 Scale = 1:5



Durabond details are offered to assist in the development of project specific details; principles and variables incorporated in all details are the sole responsibility of the project professional(s).

VERTICAL EXPANSION JOINT

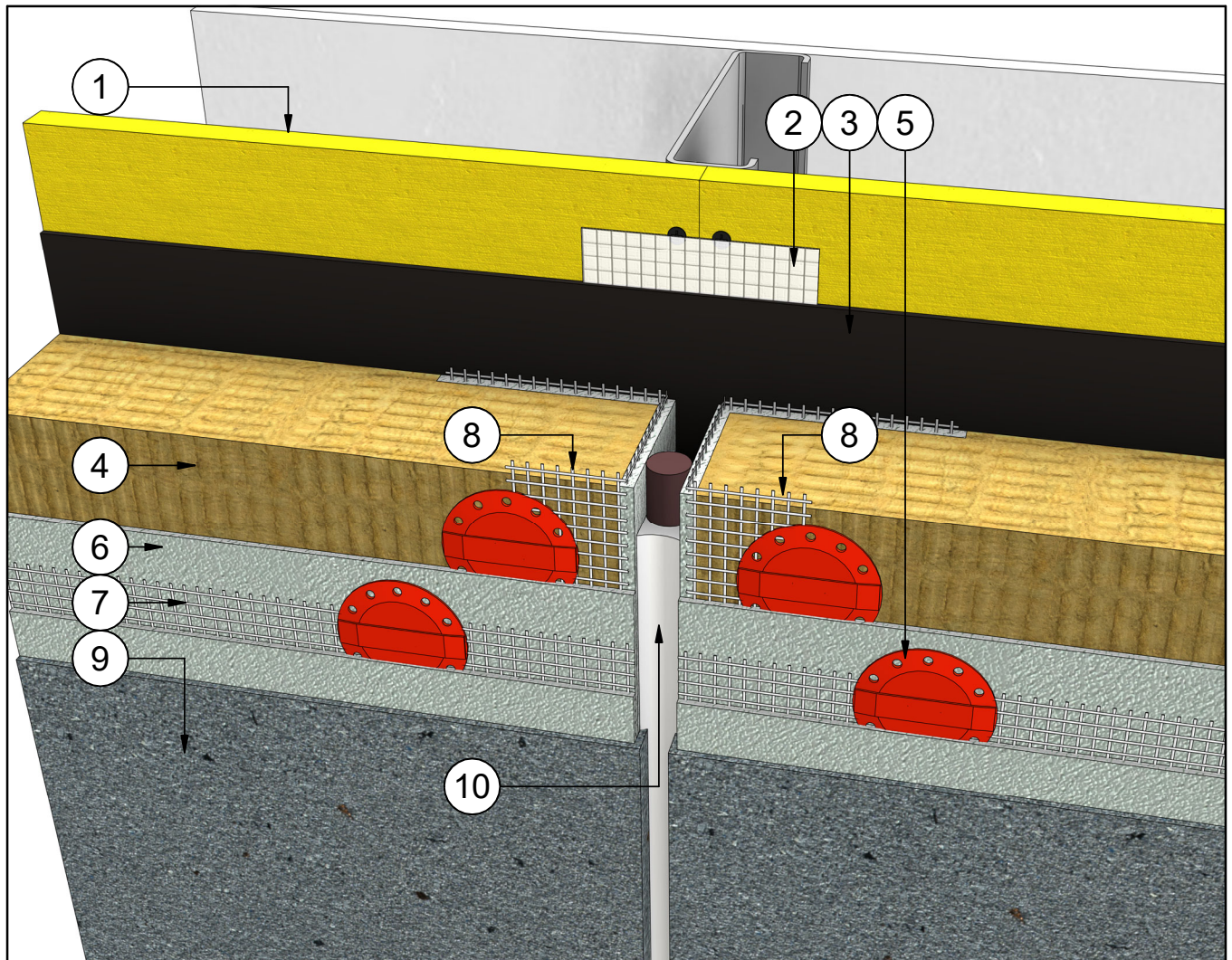

Note Text

- 1 Steel Studs Frame & Sheathing
- 2 Barrier Seam Tap (Embedded in WRB.)
- 3 WRB - Water Resistive Barrier
- 4 Equalite Insulation Board
- 5 Insulation Fastener w/ Plate
- 6 Base Coat
- 7 Fibreglass Reinforcing Mesh (Embedded in WRB)
- 8 Fibreglass Corner Mesh (Embedded in WRB)
- 8 Fibreglass Corner Mesh (Embedded in WRB)
- 9 Finish Coat
- 10 Backer Rod & Sealant



Durabond details are offered to assist in the development of project specific details; principles and variables incorporated in all details are the sole responsibility of the project professional(s).

VERTICAL EXPANSION JOINT

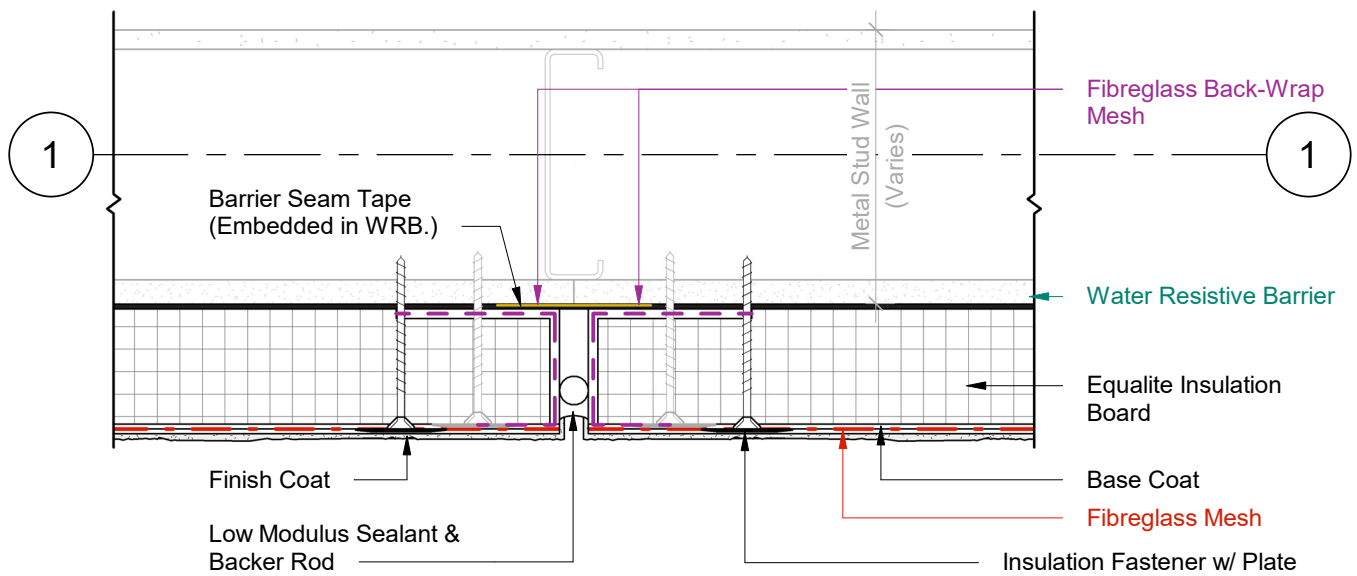

1 Plan Detail
2 Scale = 1:5



Durabond details are offered to assist in the development of project specific details; principles and variables incorporated in all details are the sole responsibility of the project professional(s).

HORIZONTAL EXPANSION JOINT

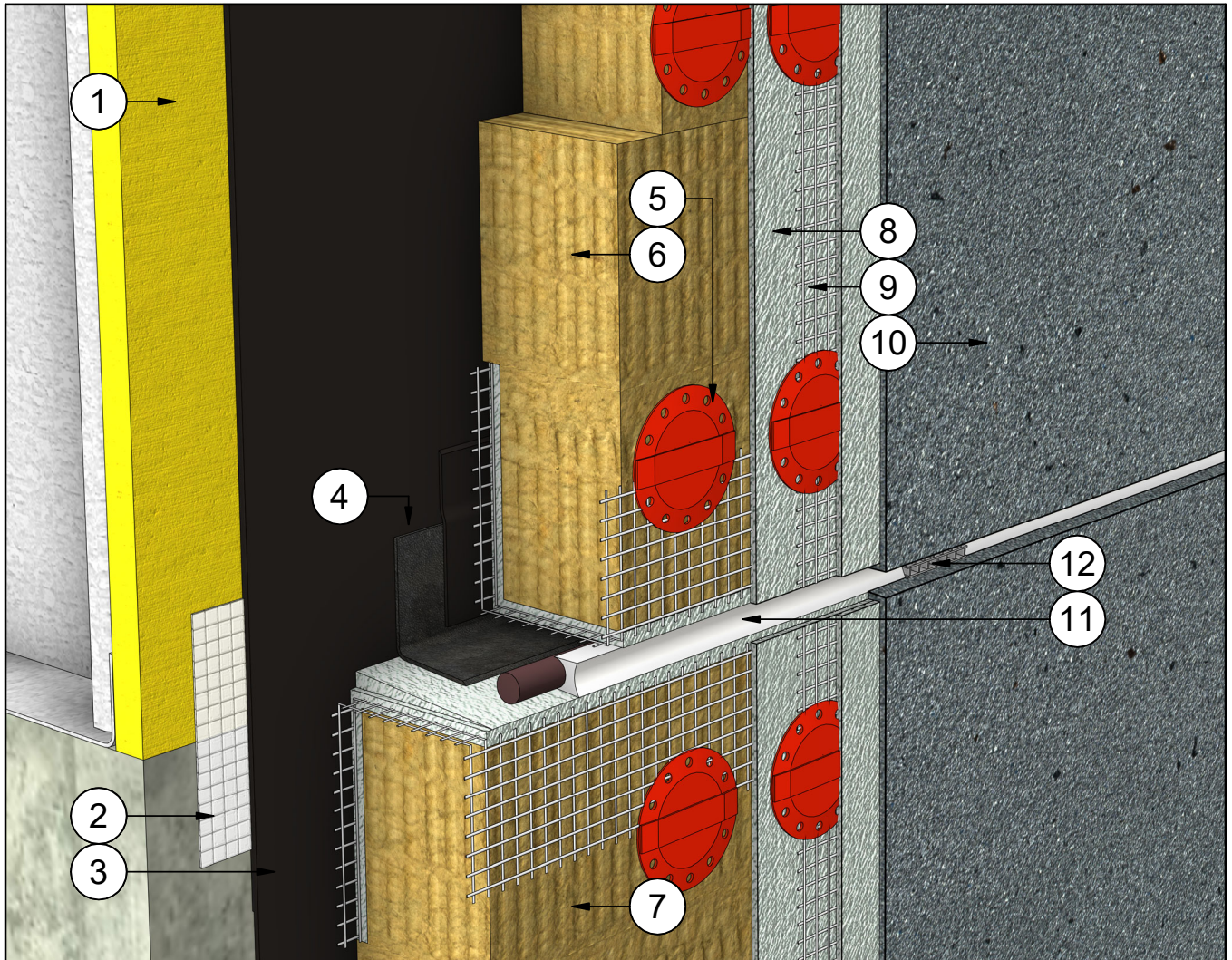

Note Text

- 1 Steel Studs Frame & Sheathing
- 2 Barrier Seam Tap (Embedded in WRB.)
- 3 WRB - Water Resistant Barrier
- 4 Tie in Membrane & Primer
- 5 Insulation Fastener w/ Plate
- 6 Equalite Boundary Board
- 7 Equalite Boundary Board
- 8 Base Coat
- 9 Fibreglass Reinforcing Mesh (Embedded in WRB)
- 10 Finish Coat
- 11 Backer Rod & Sealant
- 12 Sealant Vent

DURABOND.

Durabond details are offered to assist in the development of project specific details; principles and variables incorporated in all details are the sole responsibility of the project professional(s).

HORIZONTAL EXPANSION JOINT

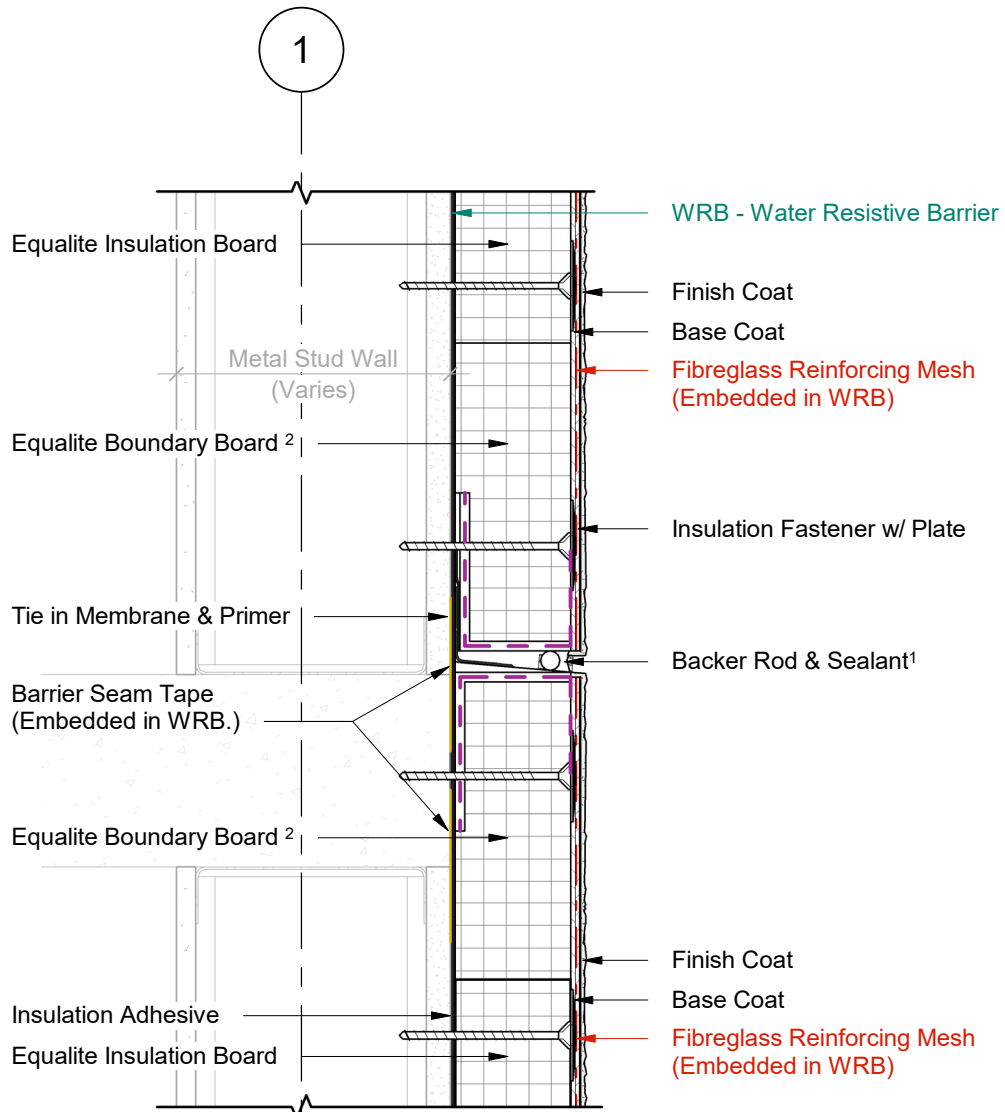

1 Wall Section
2 Scale = 1 : 5

- 1 Provide venting on Backer Rod & Sealant every 48" (1200mm) O.C. minimum.
- 2 Equalite Boundary Board includes a 4" (100mm) back wrapped mesh that is adhered to the board with a Base Coat layer.



Durabond details are offered to assist in the development of project specific details; principles and variables incorporated in all details are the sole responsibility of the project professional(s).

HORIZONTAL EXPANSION JOINT

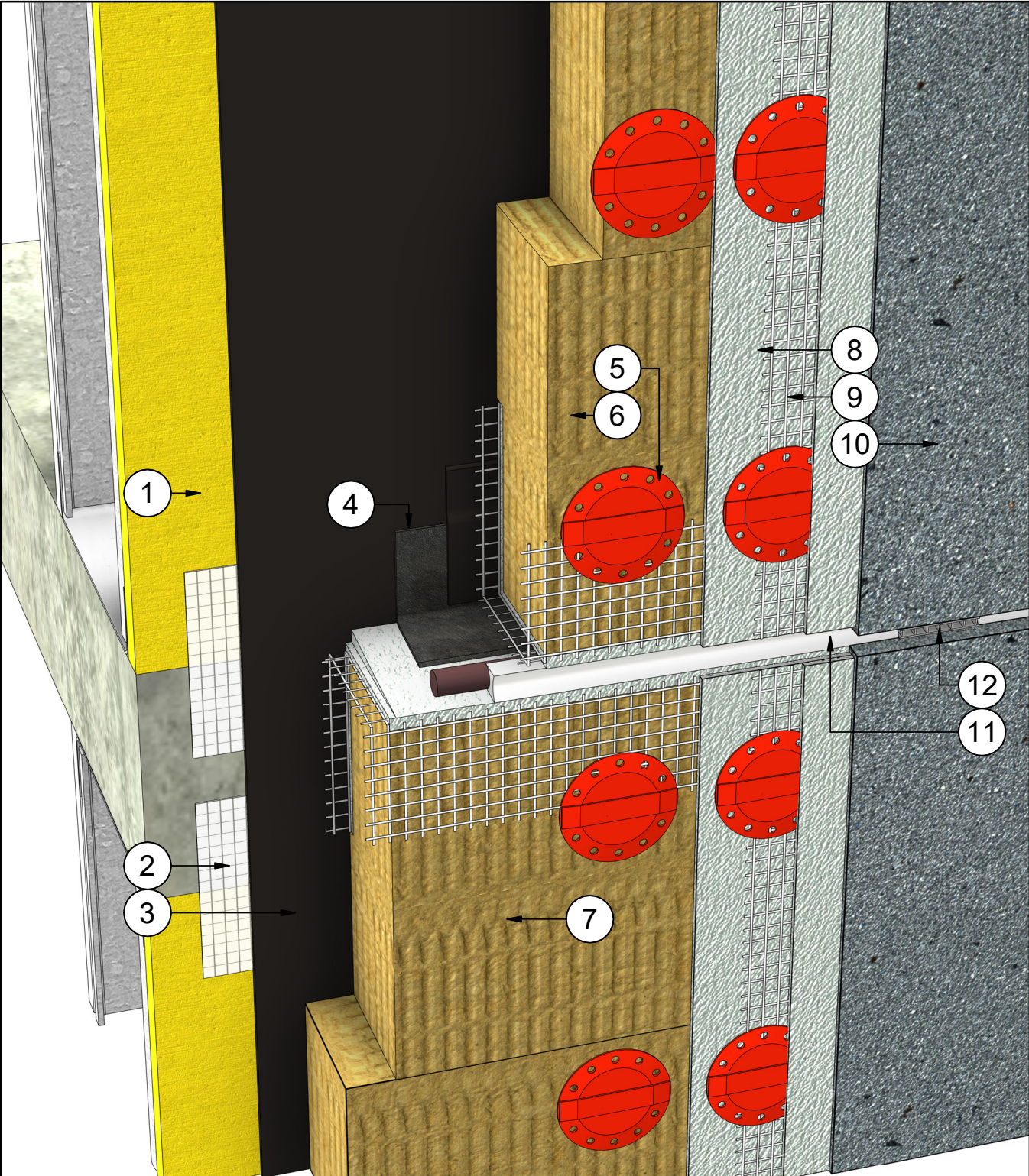

DURabond.

Durabond details are offered to assist in the development of project specific details; principles and variables incorporated in all details are the sole responsibility of the project professional(s).

TERMINATION AT MASONRY SILL

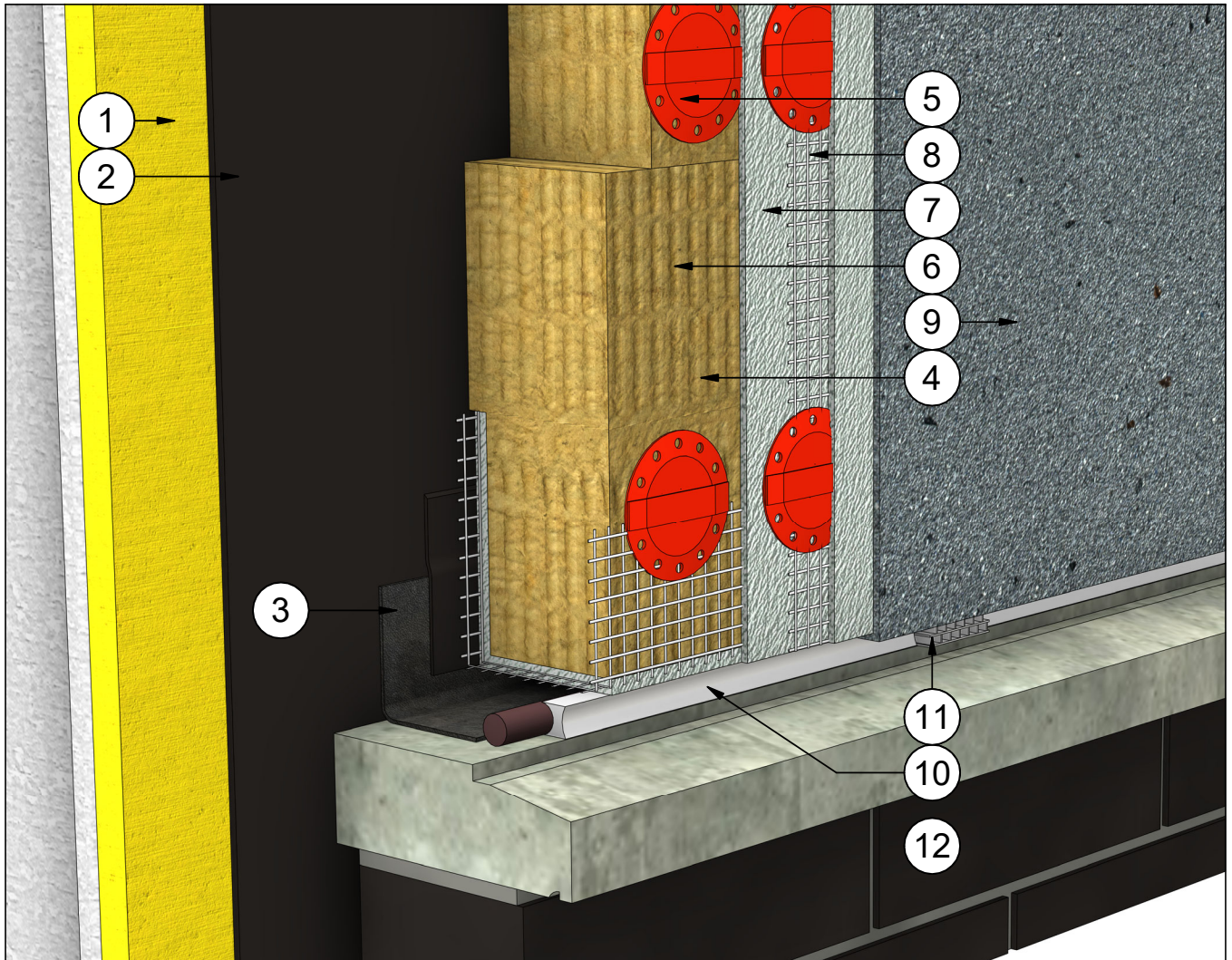

| # | Note Text | # | Note Text |
|---|---------------------------------|----|---|
| 1 | Steel Studs Framing & Sheathing | 8 | Fibreglass Reinforcing Mesh (Embedded in Base Coat) |
| 2 | WRB - Water Resitive Barrier | 9 | Finish Coat |
| 3 | Tie In Membrane & Primer | 10 | Backer Rod & Sealant |
| 4 | Fire Rated Insulation Fastener | 11 | Sealant Vent |
| 5 | Equalite Insulation Board | 12 | Alternate Cladding |
| 6 | Equalite Boundary Board | | |
| 7 | Base Coat | | |

DURABOND.

Durabond details are offered to assist in the development of project specific details; principles and variables incorporated in all details are the sole responsibility of the project professional(s).

TERMINATION AT MASONRY SILL

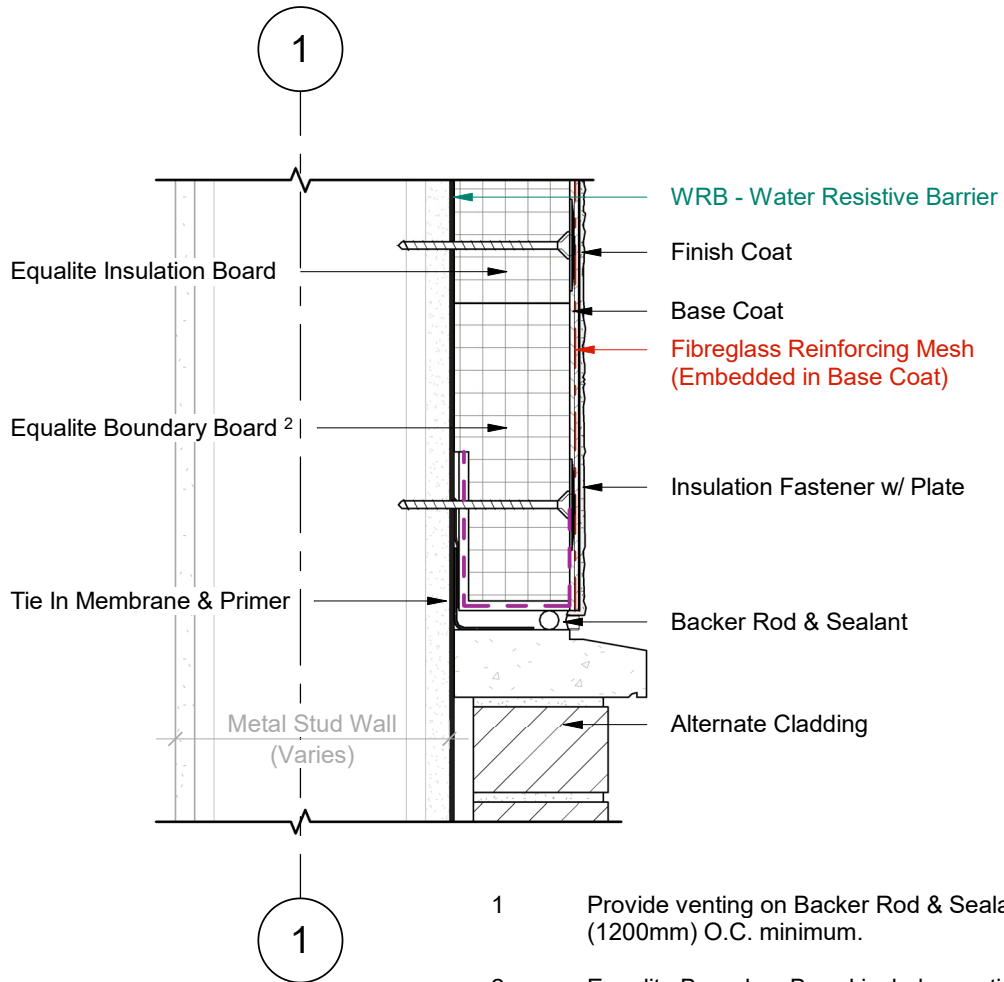

- 1 Provide venting on Backer Rod & Sealant every 48" (1200mm) O.C. minimum.
- 2 Equalite Boundary Board includes vertical drainage channels & a 4" (100mm) back wrapped mesh that is adhered to the board with a Base Coat layer.

1 Wall Section
 2 Scale = 1 : 5



Durabond details are offered to assist in the development of project specific details; principles and variables incorporated in all details are the sole responsibility of the project professional(s).

TERMINATION AT CURB

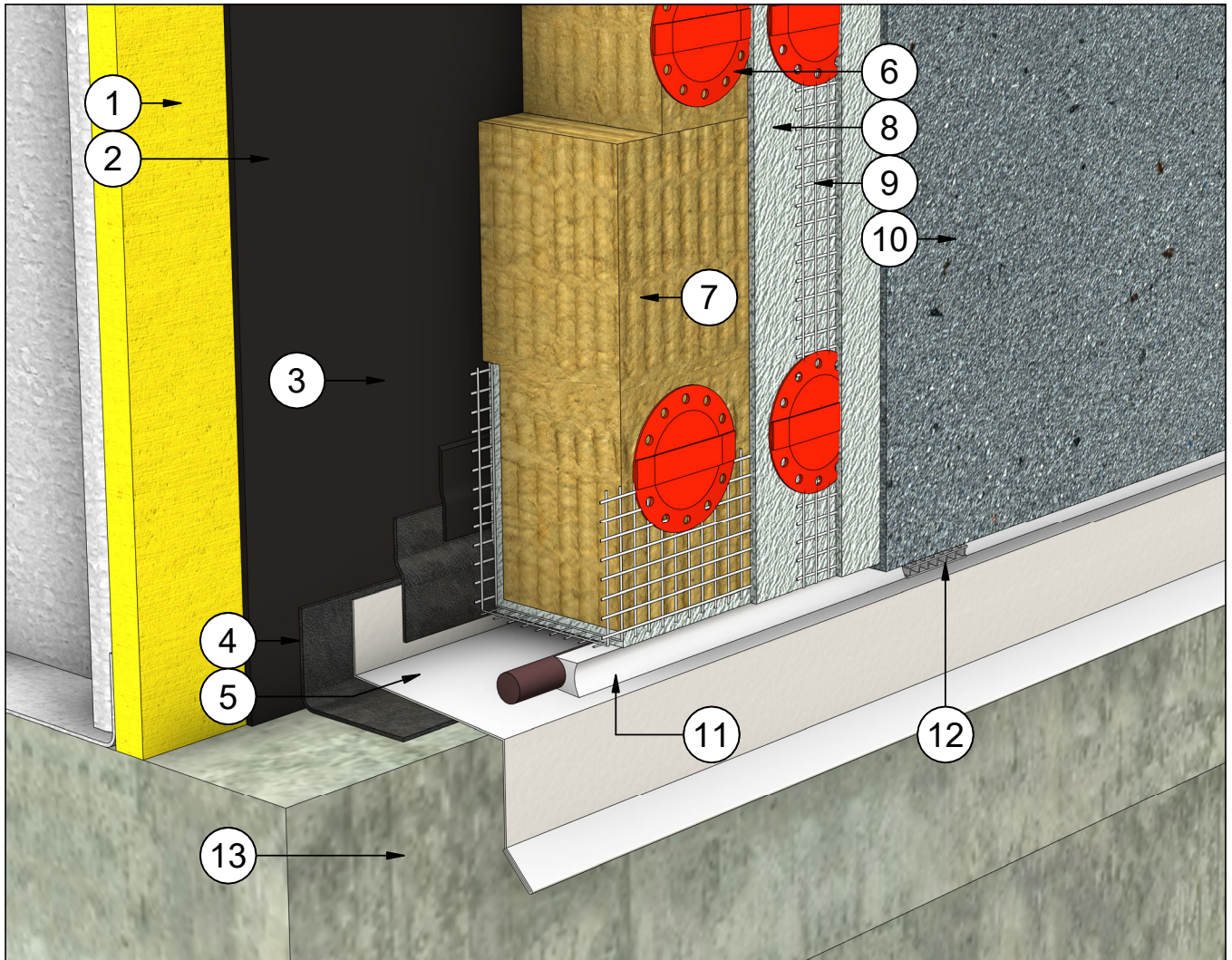

| # | Note Text | # | Note Text |
|---|---------------------------------|----|---|
| 1 | Steel Studs Framing & Sheathing | 8 | Base Coat |
| 2 | WRB - Water Resitive Barrier | 9 | Fibreglass Reinforcing Mesh (Embedded in Base Coat) |
| 3 | Tie In Membrane & Primer | 10 | Finish Coat |
| 4 | Tie In Membrane | 11 | Backer Rod & Sealant |
| 5 | Flashing | 12 | Sealant Vent |
| 6 | Insulation Fastener w/ Plate | 13 | Curb |
| 7 | Equalite Boundary Board | | |

DURabond.

Durabond details are offered to assist in the development of project specific details; principles and variables incorporated in all details are the sole responsibility of the project professional(s).

TERMINATION AT CURB

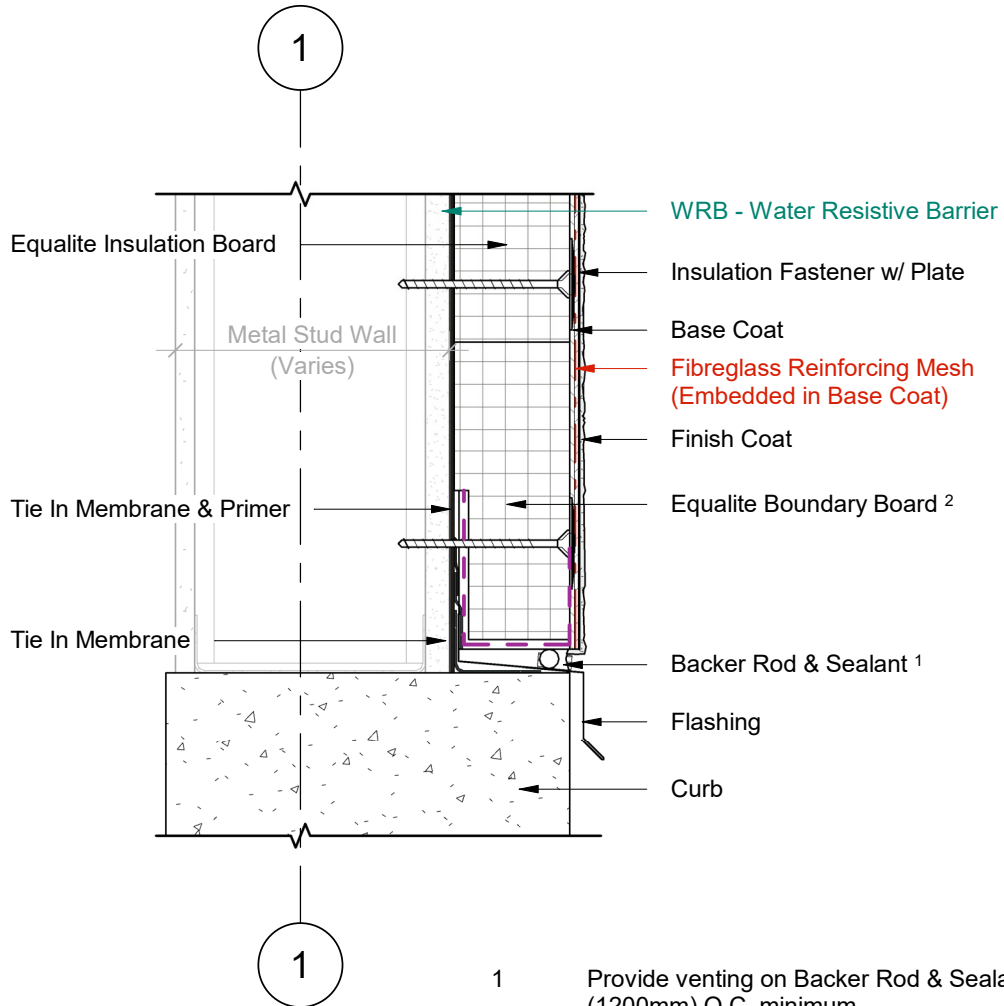

1 Wall Section
2 Scale = 1 : 5

- 1 Provide venting on Backer Rod & Sealant every 48" (1200mm) O.C. minimum.
- 2 Equalite Boundary Board includes vertical drainage channels & a 4" (100mm) back wrapped mesh that is adhered to the board with a Base Coat layer.



Durabond details are offered to assist in the development of project specific details; principles and variables incorporated in all details are the sole responsibility of the project professional(s).

**TERMINATION AT BALCONY SLAB
(OPTION A)**

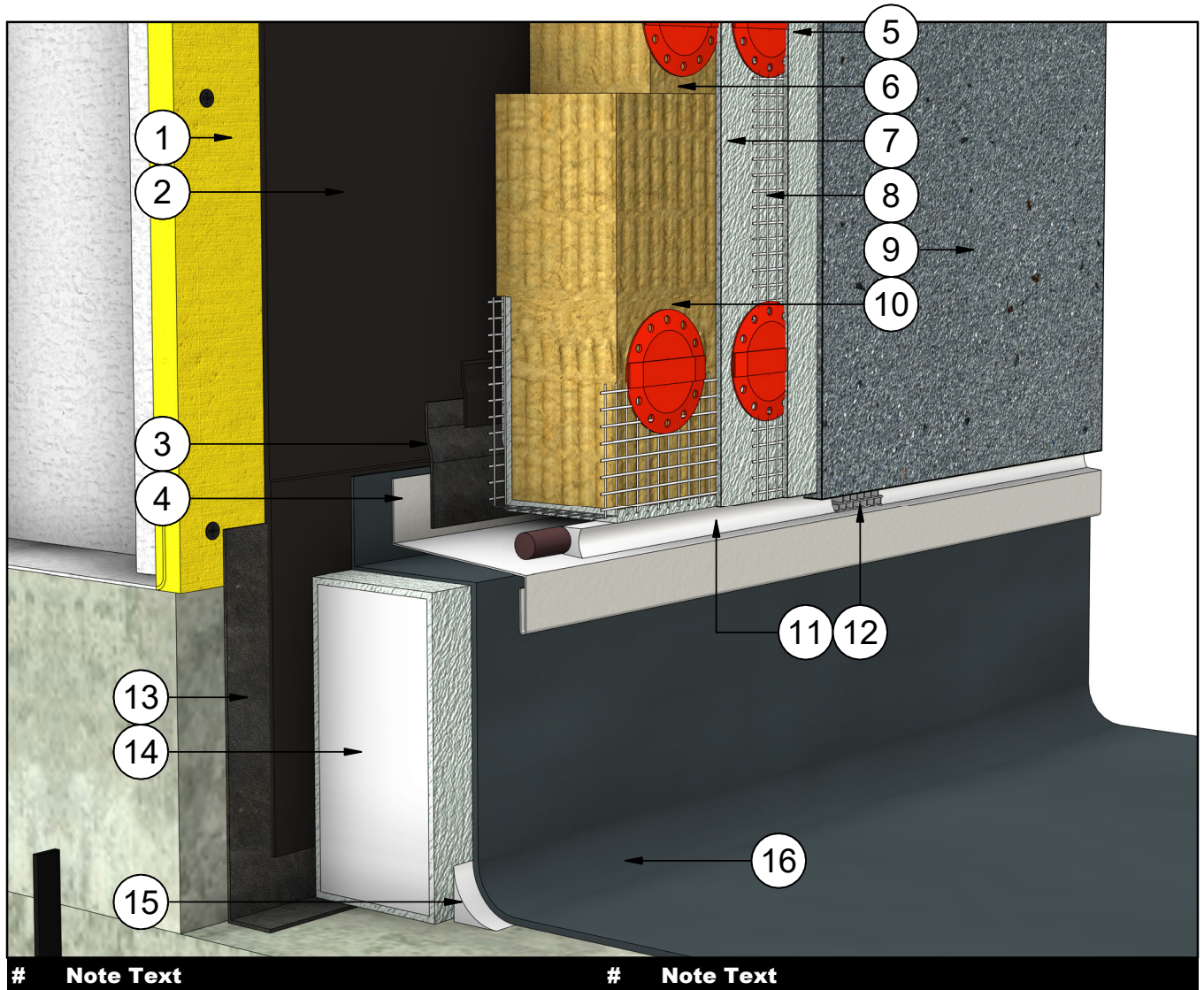

| # | Note Text | # | Note Text |
|---|---|----|---------------------------|
| 1 | Steel Studs Frame & Sheathing | 9 | Finish Coat |
| 2 | WRB - Water Resistive Barrier | 10 | Equalite Boundary Board |
| 3 | Tie In Membrane & Primer | 11 | Backer Rod & Sealant |
| 4 | Flashing | 12 | Sealant Vent |
| 5 | Insulation Fastener w/ Plate | 13 | Transition Membrane |
| 6 | Equalite Insulation Board | 14 | Pre Coated Boundary Board |
| 7 | Base Coat | 15 | Cove Sealant |
| 8 | Fibreglass Reinforcing Mesh (Embedded in Base Coat) | 16 | Balcony Waterproofing |

DURABOND.

Durabond details are offered to assist in the development of project specific details; principles and variables incorporated in all details are the sole responsibility of the project professional(s).

**TERMINATION AT BALCONY SLAB
(OPTION A)**

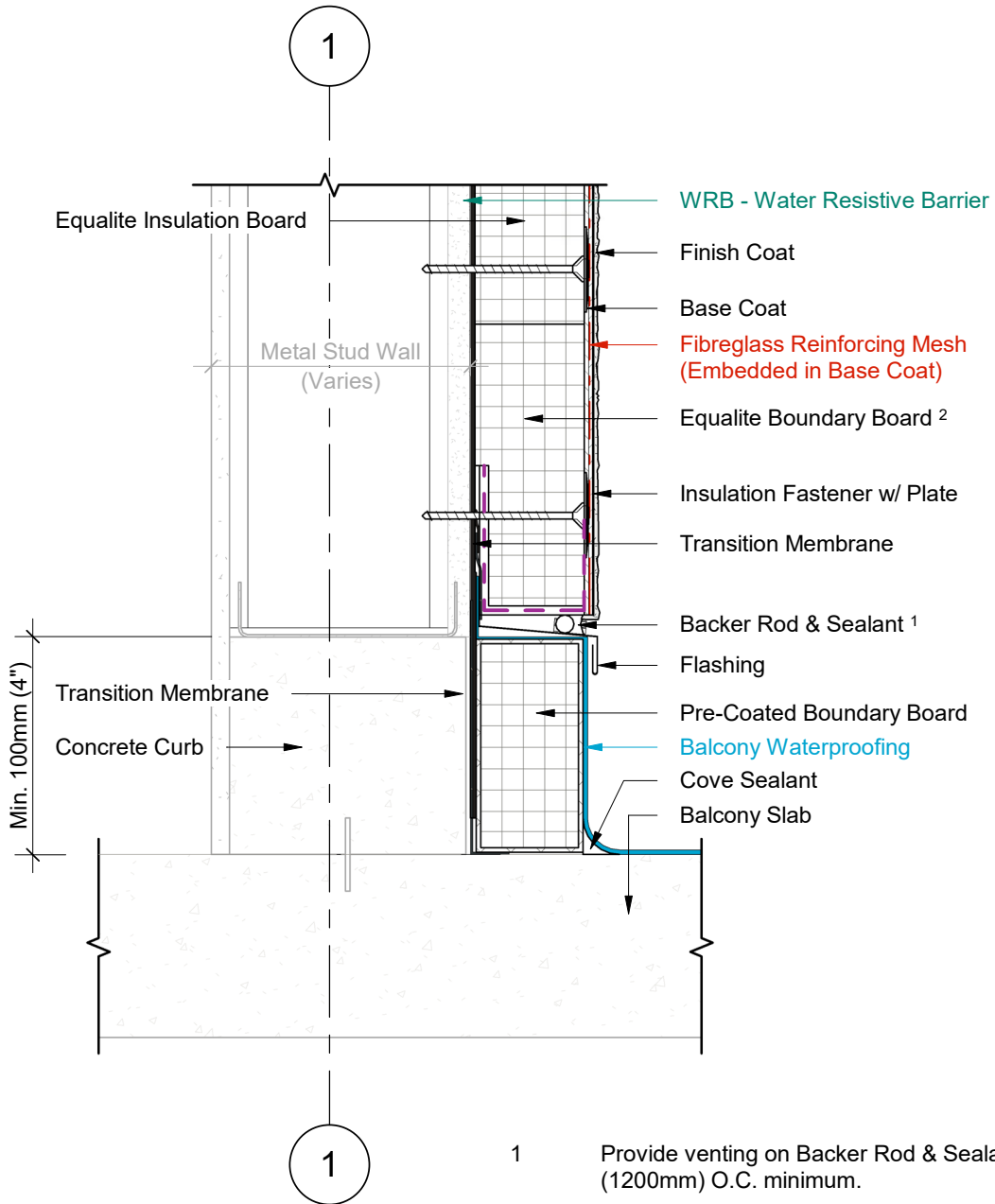

1 Wall Section
2 Scale = 1 : 5

- 1 Provide venting on Backer Rod & Sealant every 48" (1200mm) O.C. minimum.
- 2 Equalite Boundary Board includes a 4" (100mm) back wrapped mesh that is adhered to the board with a Base Coat layer.



Durabond details are offered to assist in the development of project specific details; principles and variables incorporated in all details are the sole responsibility of the project professional(s).

**TERMINATION AT BALCONY SLAB
(OPTION B)**

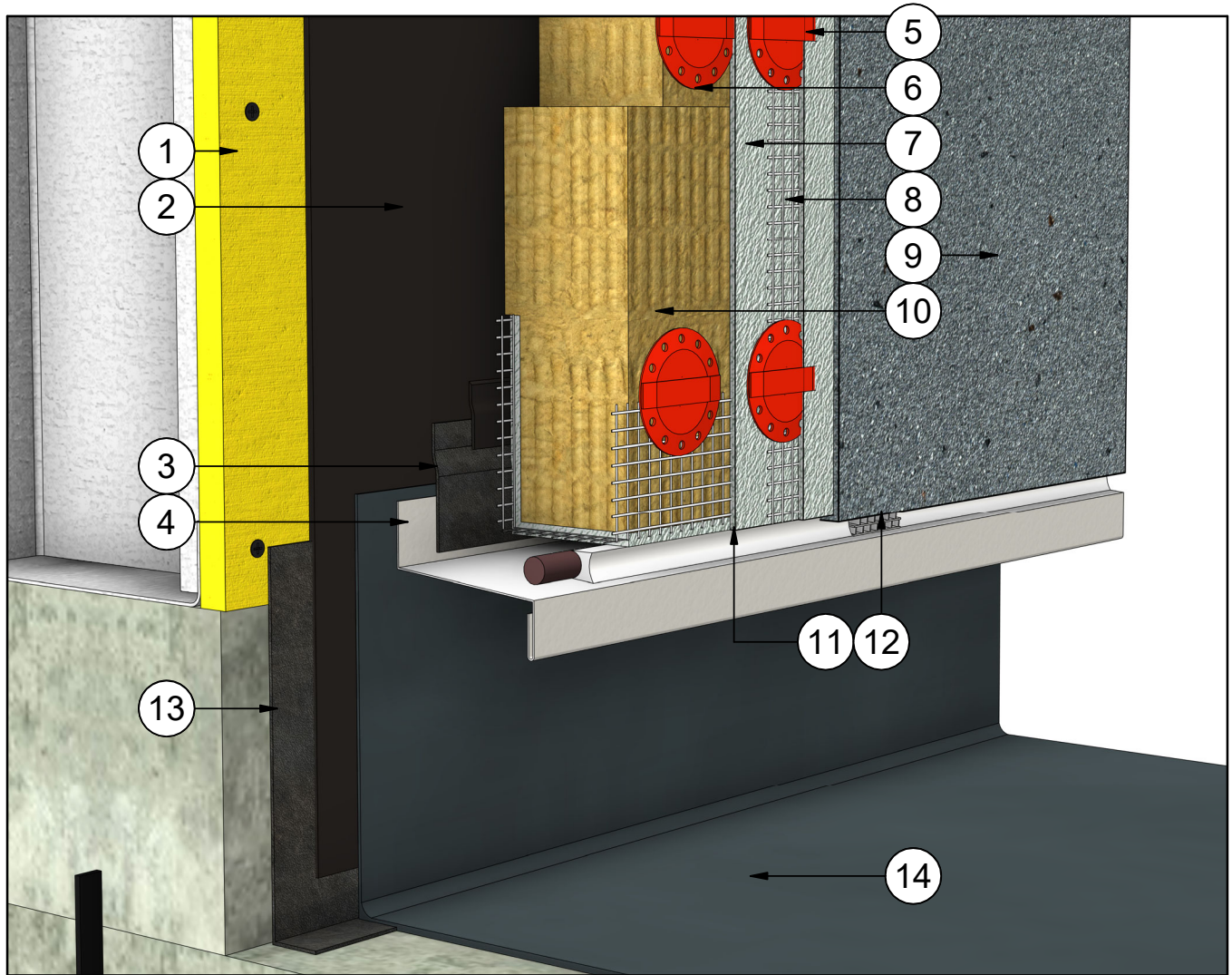

| # | Note Text | # | Note Text |
|---|-------------------------------|----|---|
| 1 | Steel Studs Frame & Sheathing | 8 | Fibreglass Reinforcing Mesh (Embedded in Base Coat) |
| 2 | WRB - Water Resisive Barrier | 9 | Finish Coat |
| 3 | Tie In Membrane & Primer | 10 | Insulite Boundary Board |
| 4 | Flashing | 11 | Backer Rod & Sealant |
| 5 | Insulation Fastener w/ Plate | 12 | Sealant Vent |
| 6 | Insulite Insulation Board | 13 | Transition Membrane |
| 7 | Base Coat | 14 | Balcony Waterproofing |

DURABOND.

Durabond details are offered to assist in the development of project specific details; principles and variables incorporated in all details are the sole responsibility of the project professional(s).

TERMINATION AT BALCONY SLAB (OPTION B)

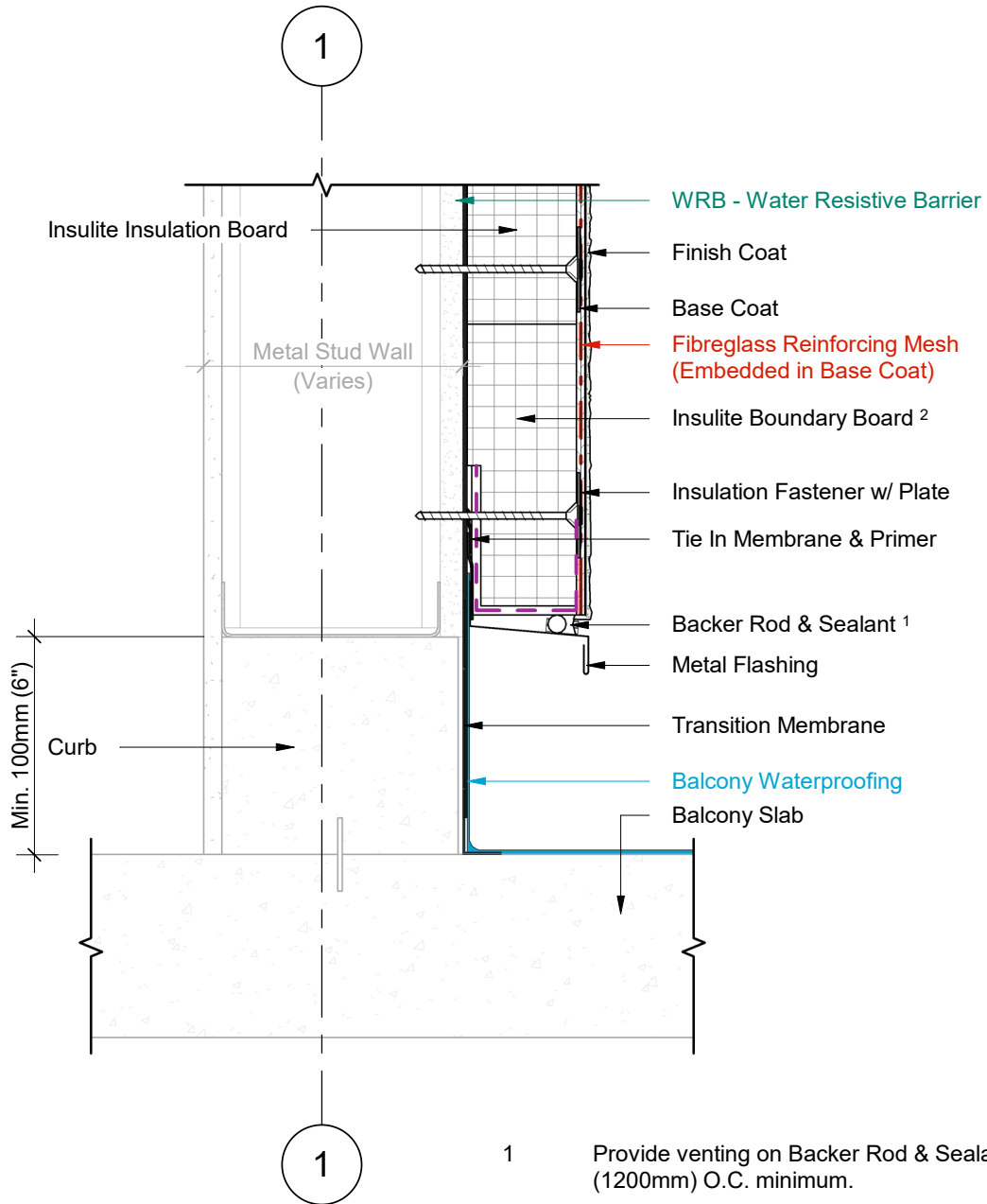

- 1 Provide venting on Backer Rod & Sealant every 48" (1200mm) O.C. minimum.
- 2 Equalite Boundary Board includes a 4" (100mm) back wrapped mesh that is adhered to the board with a Base Coat layer.

1 Wall Section
2 Scale = 1 : 5

DURABOND.

Durabond details are offered to assist in the development of project specific details; principles and variables incorporated in all details are the sole responsibility of the project professional(s).

**TERMINATION AT BALCONY SLAB
(OPTION C)**

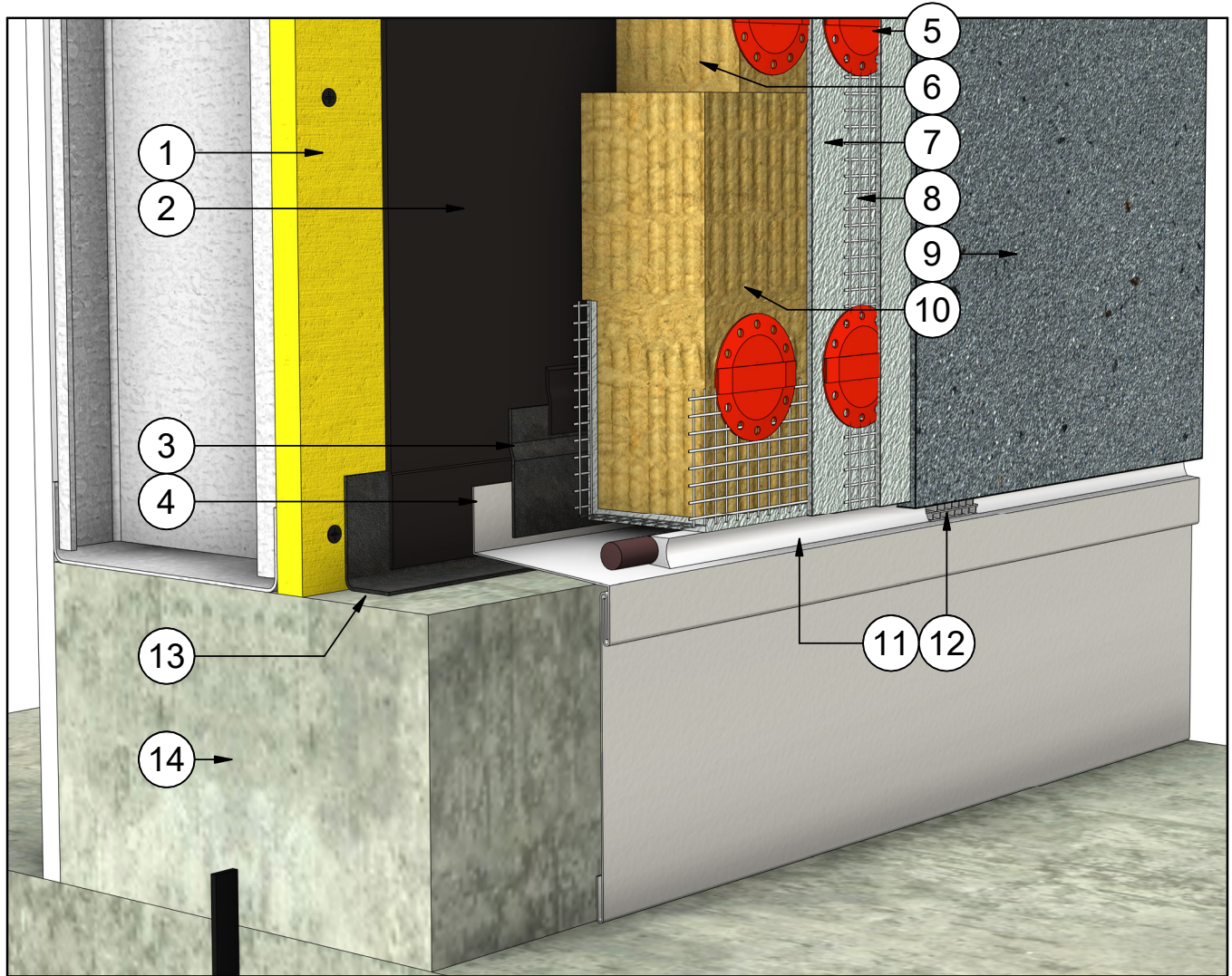

| # | Note Text | # | Note Text |
|---|-------------------------------|----|---|
| 1 | Steel Studs Frame & Sheathing | 8 | Fibreglass Reinforcing Mesh (Embedded in Base Coat) |
| 2 | WRB - Water Resistive Barrier | 9 | Finish Coat |
| 3 | Tie In Membrane & Primer | 10 | Equalite Boundary Board |
| 4 | Flashing & Counterflashing | 11 | Backer Rod & Sealant |
| 5 | Insulation Fastener w/ Plate | 12 | Sealant Vent |
| 6 | Equalite Insulation Board | 13 | Transition Membrane |
| 7 | Base Coat | 14 | Curb |

DURABOND.

Durabond details are offered to assist in the development of project specific details; principles and variables incorporated in all details are the sole responsibility of the project professional(s).

**TERMINATION AT BALCONY SLAB
(OPTION C)**

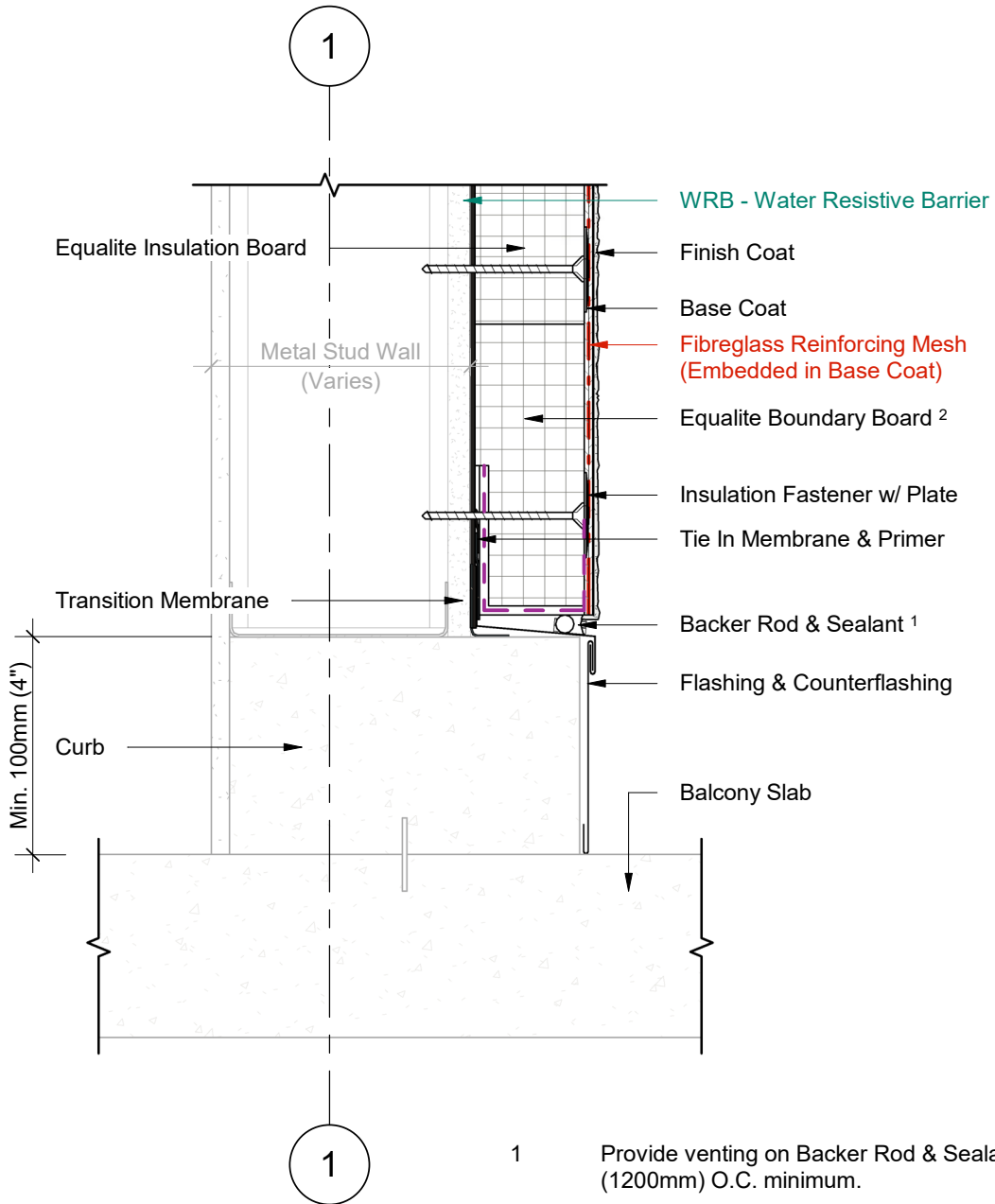

- 1 Provide venting on Backer Rod & Sealant every 48" (1200mm) O.C. minimum.
- 2 Equalite Boundary Board includes a 4" (100mm) back wrapped mesh that is adhered to the board with a Base Coat layer.

1 Wall Section
2 Scale = 1 : 5



Durabond details are offered to assist in the development of project specific details; principles and variables incorporated in all details are the sole responsibility of the project professional(s).

**TERMINATION AT BALCONY SLAB
(OPTION D)**

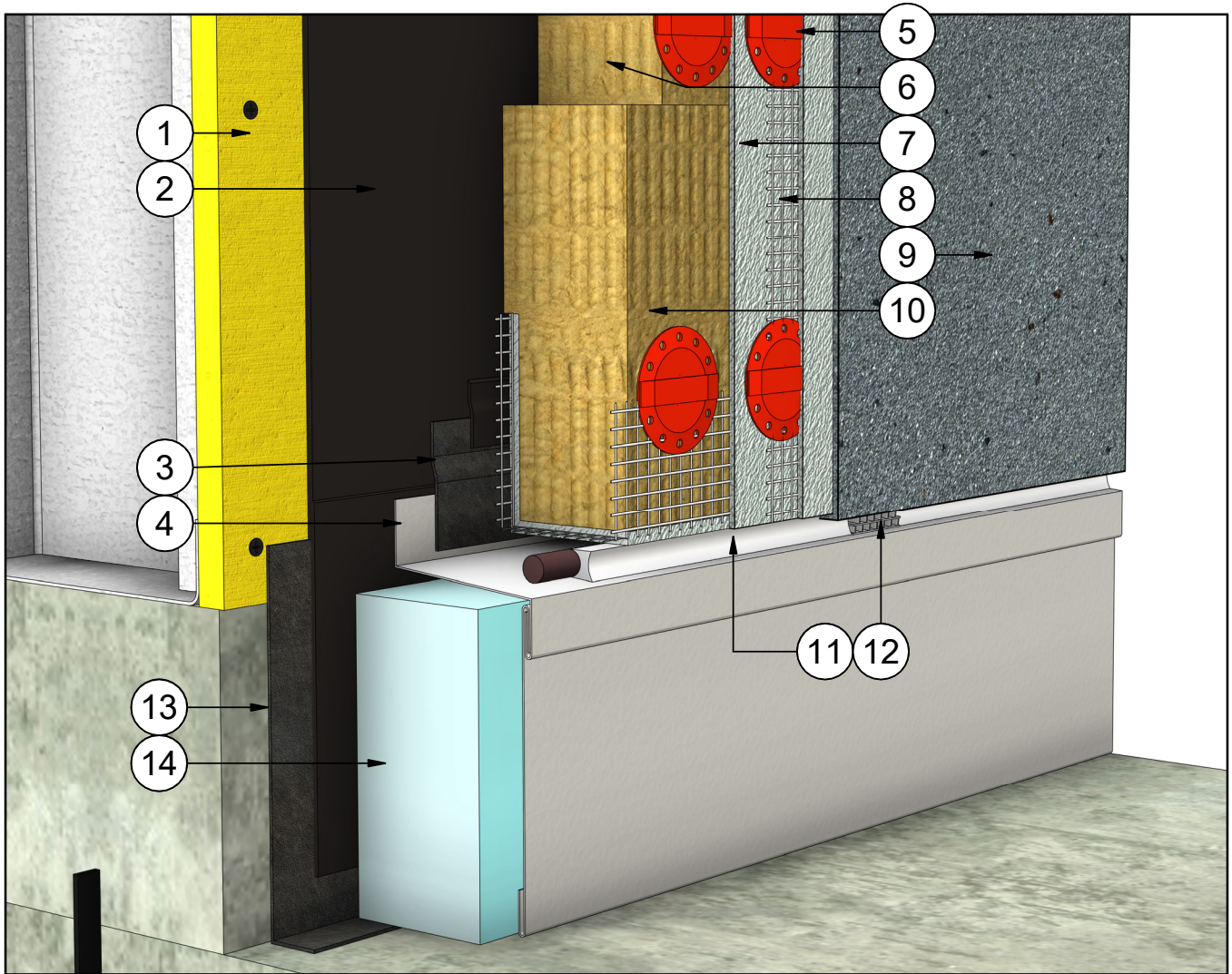

| # | Note Text | # | Note Text |
|---|-------------------------------|----|---|
| 1 | Steel Studs Frame & Sheathing | 8 | Fibreglass Reinforcing Mesh (Embedded in Base Coat) |
| 2 | WRB - Water Resistive Barrier | 9 | Finish Coat |
| 3 | Tie In Membrane & Primer | 10 | Equalite Boundary Board |
| 4 | Flashing | 11 | Backer Rod & Sealant |
| 5 | Insulation Fastener w/ Plate | 12 | Sealant Vent |
| 6 | Equalite Insulation Board | 13 | Transition Membrane |
| 7 | Base Coat | 14 | Rigid Insulation |

DURABOND.

Durabond details are offered to assist in the development of project specific details; principles and variables incorporated in all details are the sole responsibility of the project professional(s).

**TERMINATION AT BALCONY SLAB
(OPTION D)**

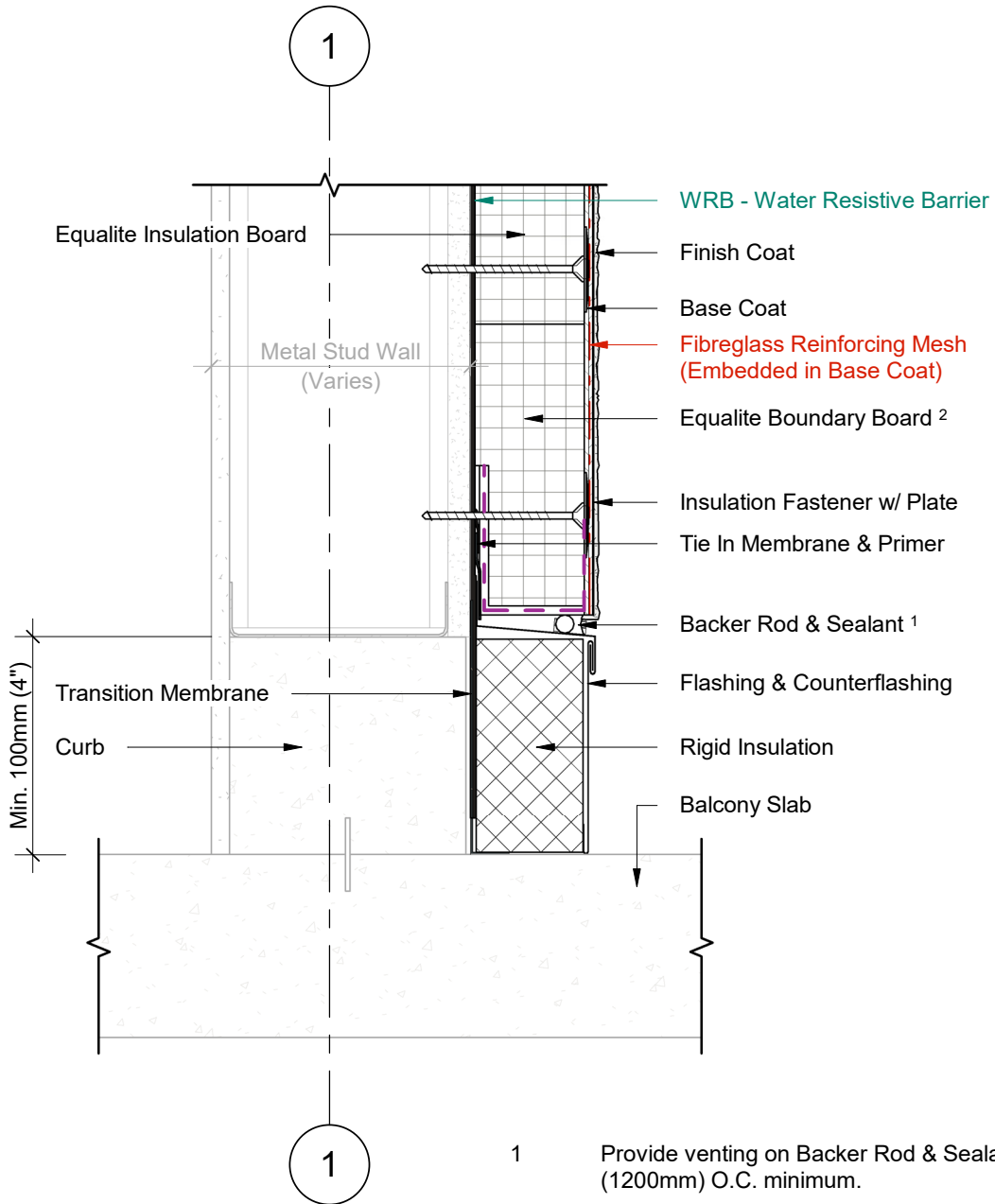

- 1 Provide venting on Backer Rod & Sealant every 48" (1200mm) O.C. minimum.
- 2 Equalite Boundary Board includes a 4" (100mm) back wrapped mesh that is adhered to the board with a Base Coat layer.

1 Wall Section
2 Scale = 1 : 5



Durabond details are offered to assist in the development of project specific details; principles and variables incorporated in all details are the sole responsibility of the project professional(s).

TERMINATION BELOW BALCONY SLAB

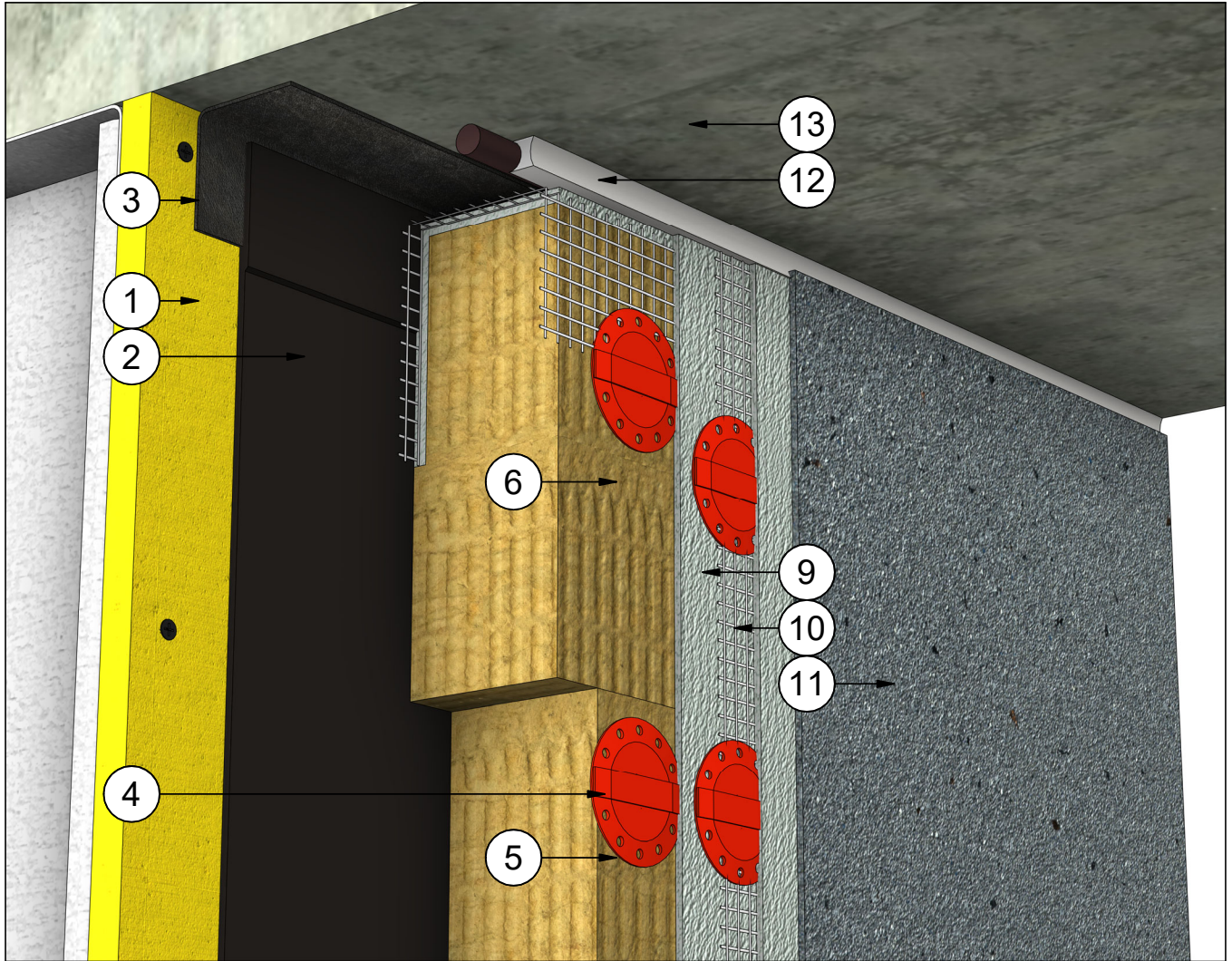

| # | Note Text | # | Note Text |
|---|-------------------------------|----|---|
| 1 | Steel Studs Frame & Sheathing | 9 | Base Coat |
| 2 | WRB - Water Resistive Barrier | 10 | Fiberglass Reinforcing Mesh (Embedded in Base Coat) |
| 3 | Tie In Membrane | 11 | Finish Coat |
| 4 | Insulation Fastener w/ Plate | 12 | Backer Rod & Sealant |
| 5 | Equalite Insulation Board | 13 | Balcony Slab |
| 6 | Equalite Boundary Board | | |

DURABOND.

Durabond details are offered to assist in the development of project specific details; principles and variables incorporated in all details are the sole responsibility of the project professional(s).

TERMINATION BELOW BALCONY SLAB

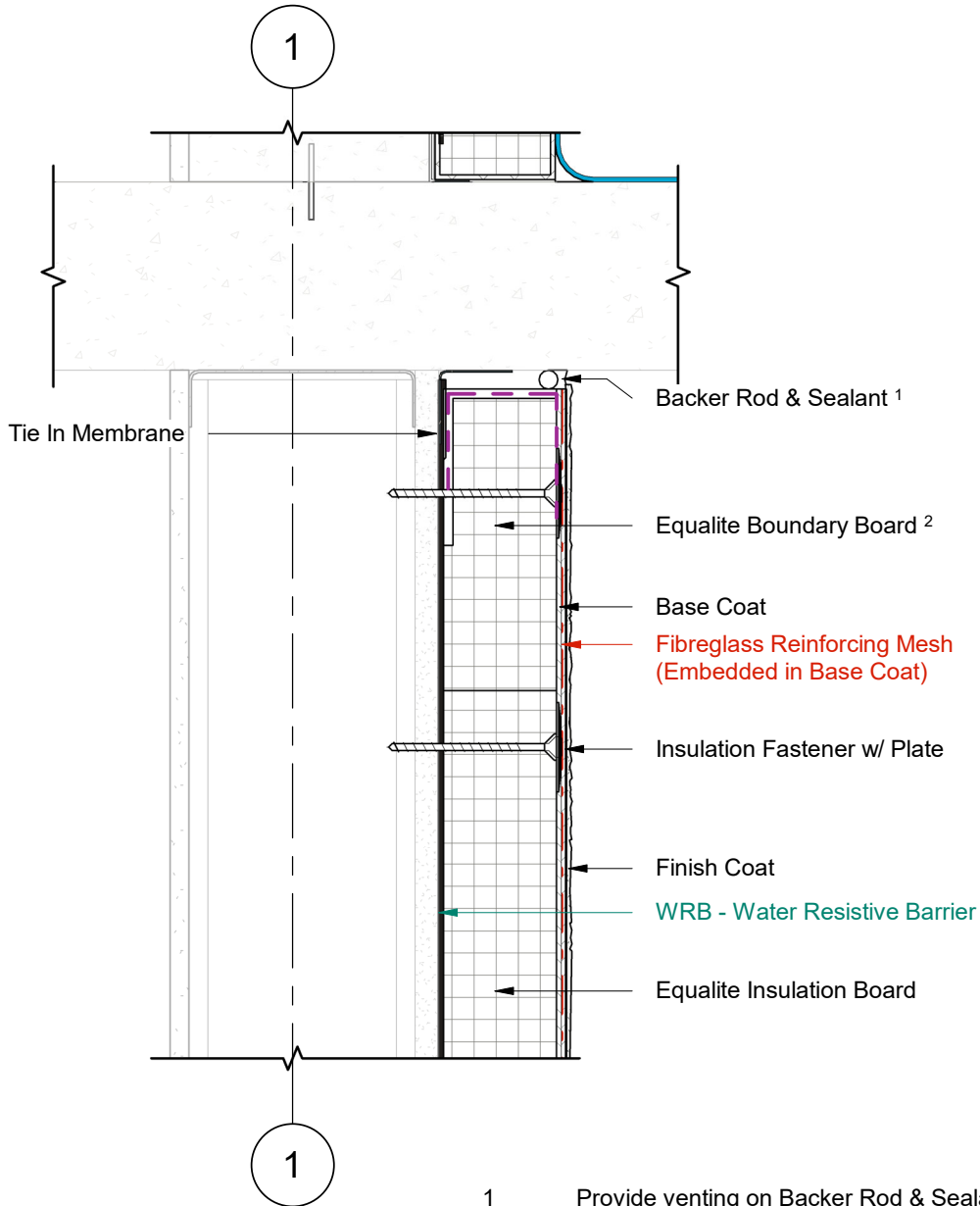

1 Wall Section
2 Scale = 1 : 5

- 1 Provide venting on Backer Rod & Sealant every 48" (1200mm) O.C. minimum.
- 2 Equalite Boundary Board includes a 4" (100mm) back wrapped mesh that is adhered to the board with a Base Coat layer.



Durabond details are offered to assist in the development of project specific details; principles and variables incorporated in all details are the sole responsibility of the project professional(s).

FOUNDATION TERMINATION WITH FLASHING

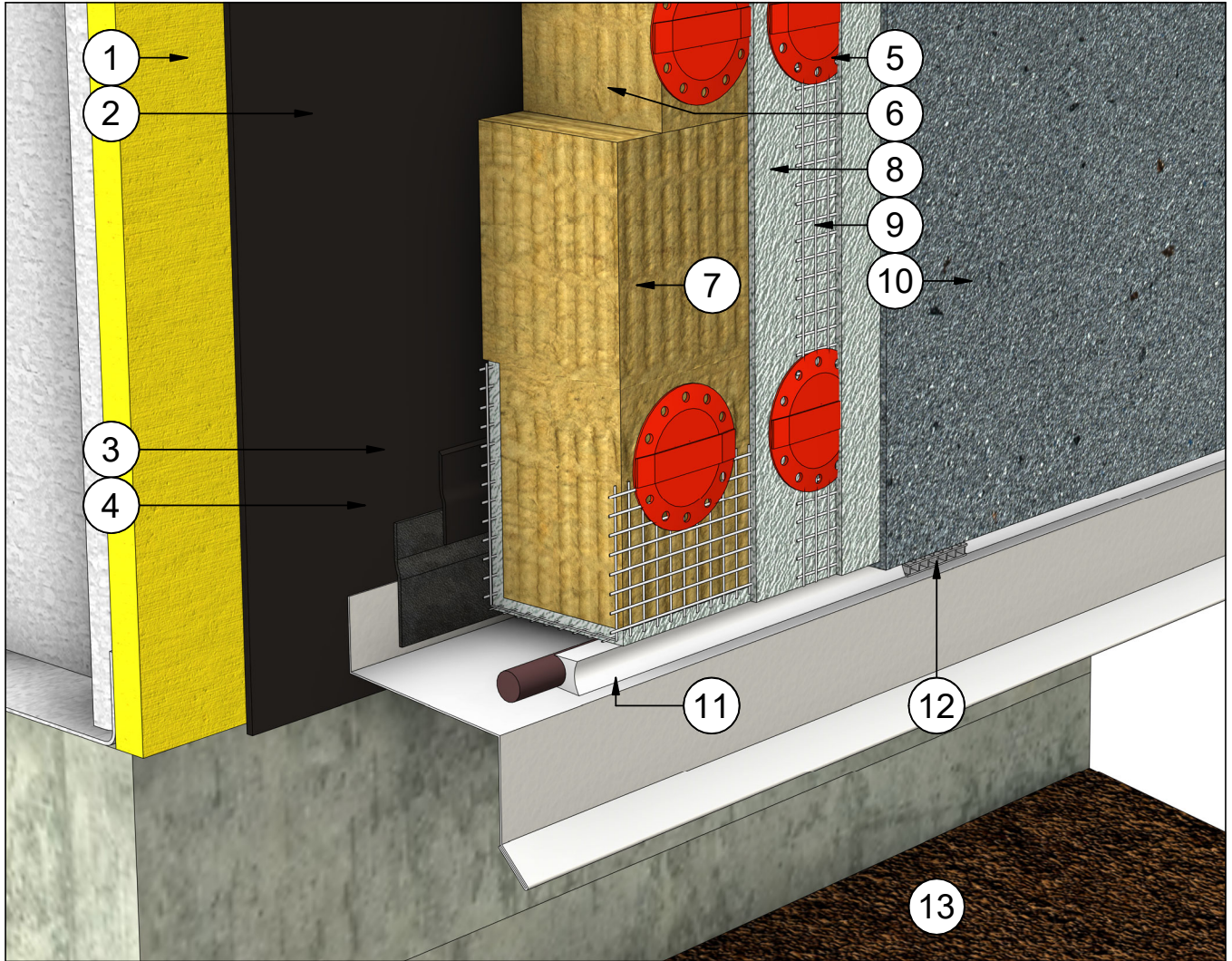

| # | Note Text | # | Note Text |
|---|-------------------------------|----|---|
| 1 | Steel Studs Frame & Sheathing | 8 | Base Coat |
| 2 | WRB - Water Resistive Barrier | 9 | Fibreglass Reinforcing Mesh (Embedded in Base Coat) |
| 3 | Tie In Membrane & Primer | 10 | Finish Coat |
| 4 | Flashing | 11 | Backer Rod & Sealant |
| 5 | Insulation Adhesive | 12 | Sealant Vent |
| 6 | Equalite Insulation Board | 13 | Grade |
| 7 | Equalite Boundary Board | | |

DURABOND.

Durabond details are offered to assist in the development of project specific details; principles and variables incorporated in all details are the sole responsibility of the project professional(s).

FOUNDATION TERMINATION WITH FLASHING

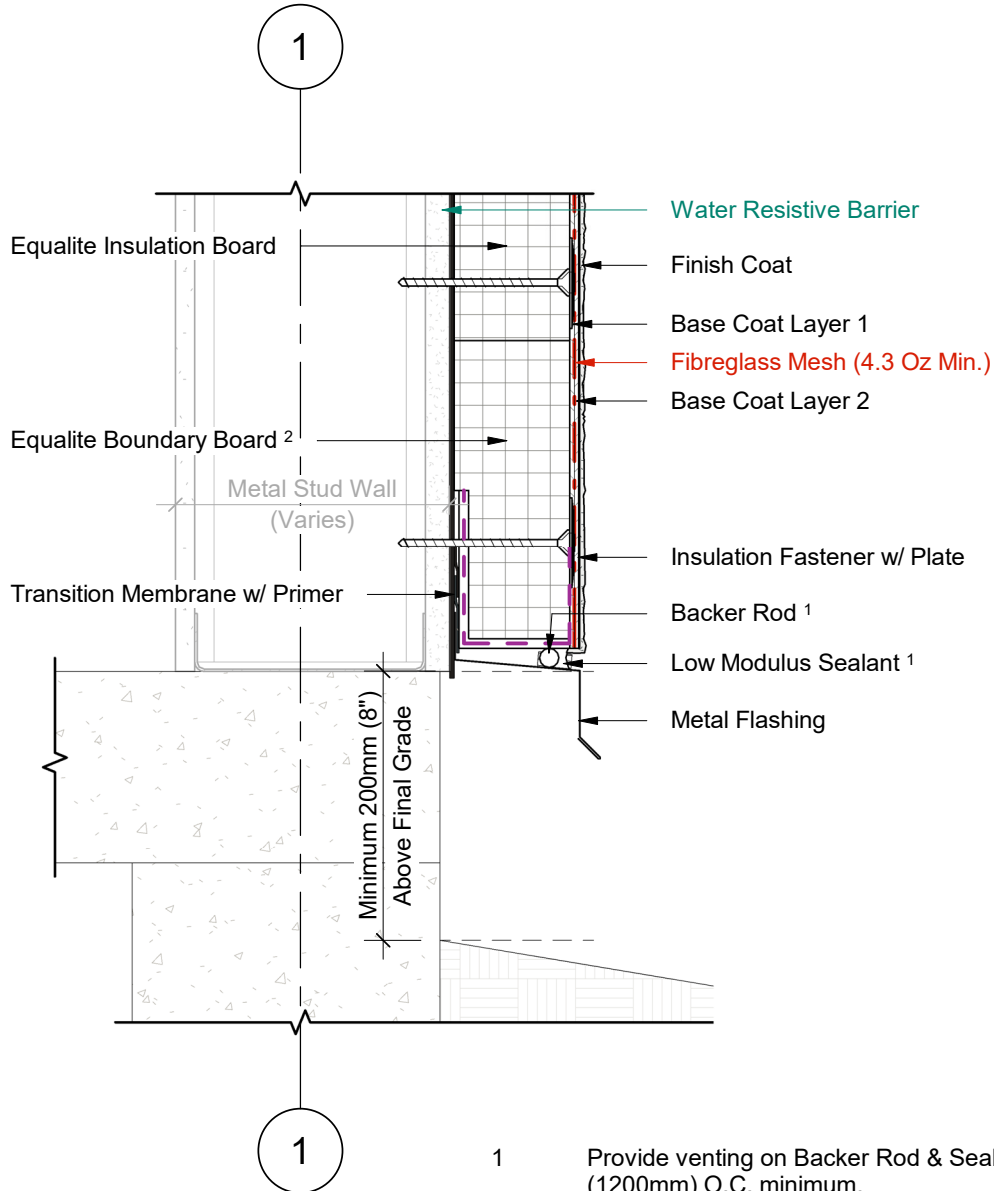

- 1 Provide venting on Backer Rod & Sealant every 48" (1200mm) O.C. minimum.
- 2 Equalite Boundary Board includes a 4" (100mm) back wrapped mesh that is adhered to the board with a Base Coat layer.

1 Wall Section
 2 Scale = 1 : 5



Durabond details are offered to assist in the development of project specific details; principles and variables incorporated in all details are the sole responsibility of the project professional(s).

INSULATED FOUNDATION WITH FLASHING

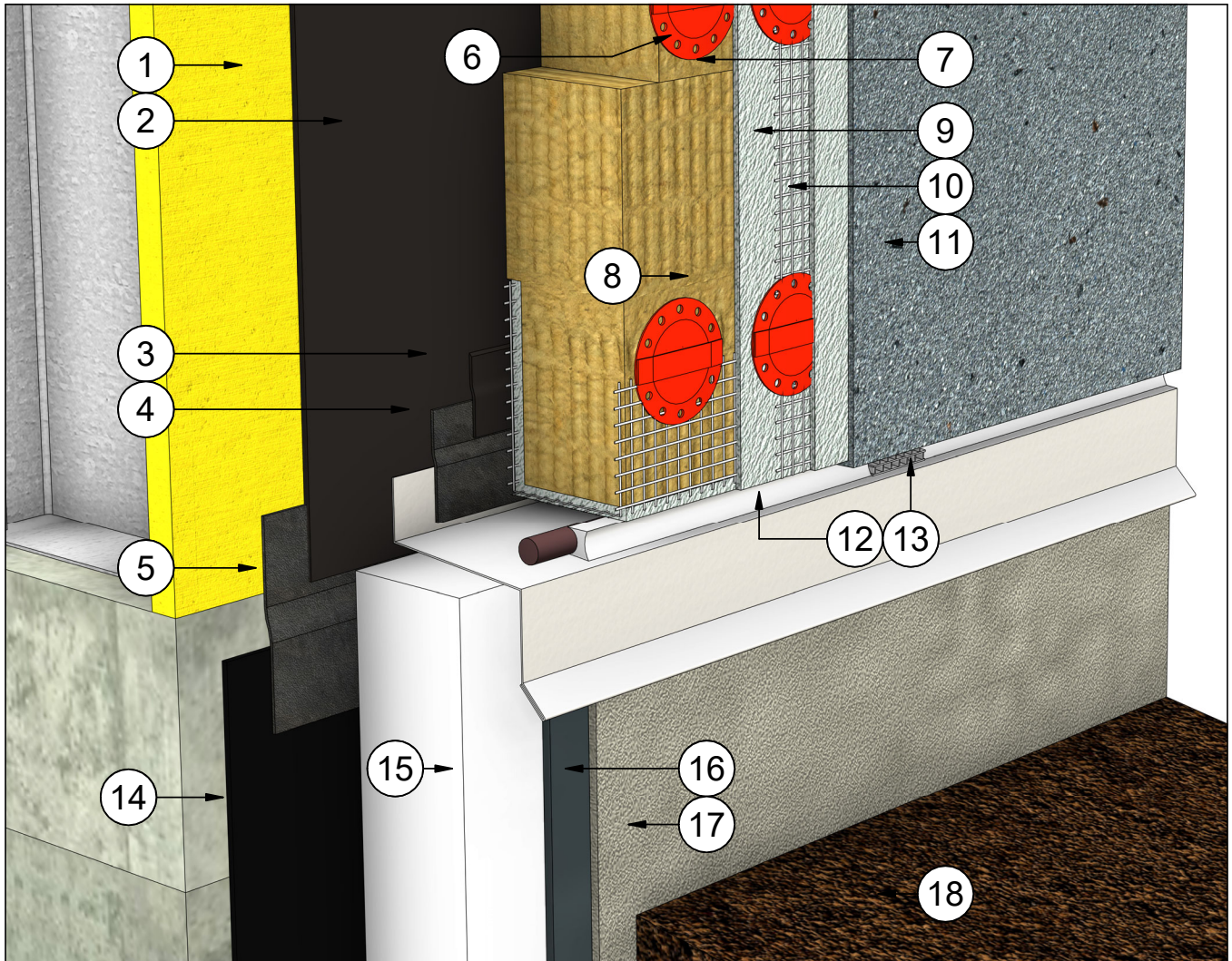

| # | Note Text | # | Note Text |
|---|-------------------------------|----|---|
| 1 | Steel Studs Frame & Sheathing | 10 | Fibreglass Reinforcing Mesh (Embedded in Base Coat) |
| 2 | WRB - Water Resistive Barrier | 11 | Finish Coat |
| 3 | Tie In Membrane & Primer | 12 | Backer Rod & Sealant |
| 4 | Flashing | 13 | Sealant Vent |
| 5 | Tie In Membrane | 14 | Air/Vapour Barrier |
| 6 | Insulation Fastener w/ Plate | 15 | Below Grade EPS Insulation |
| 7 | Equalite Insulation Board | 16 | Elastomeric Waterproofing |
| 8 | Equalite Boundary Board | 17 | Latex Modified Cement |
| 9 | Base Coat | 18 | Grade |

DURABOND.

Durabond details are offered to assist in the development of project specific details; principles and variables incorporated in all details are the sole responsibility of the project professional(s).

INSULATED FOUNDATION WITH FLASHING

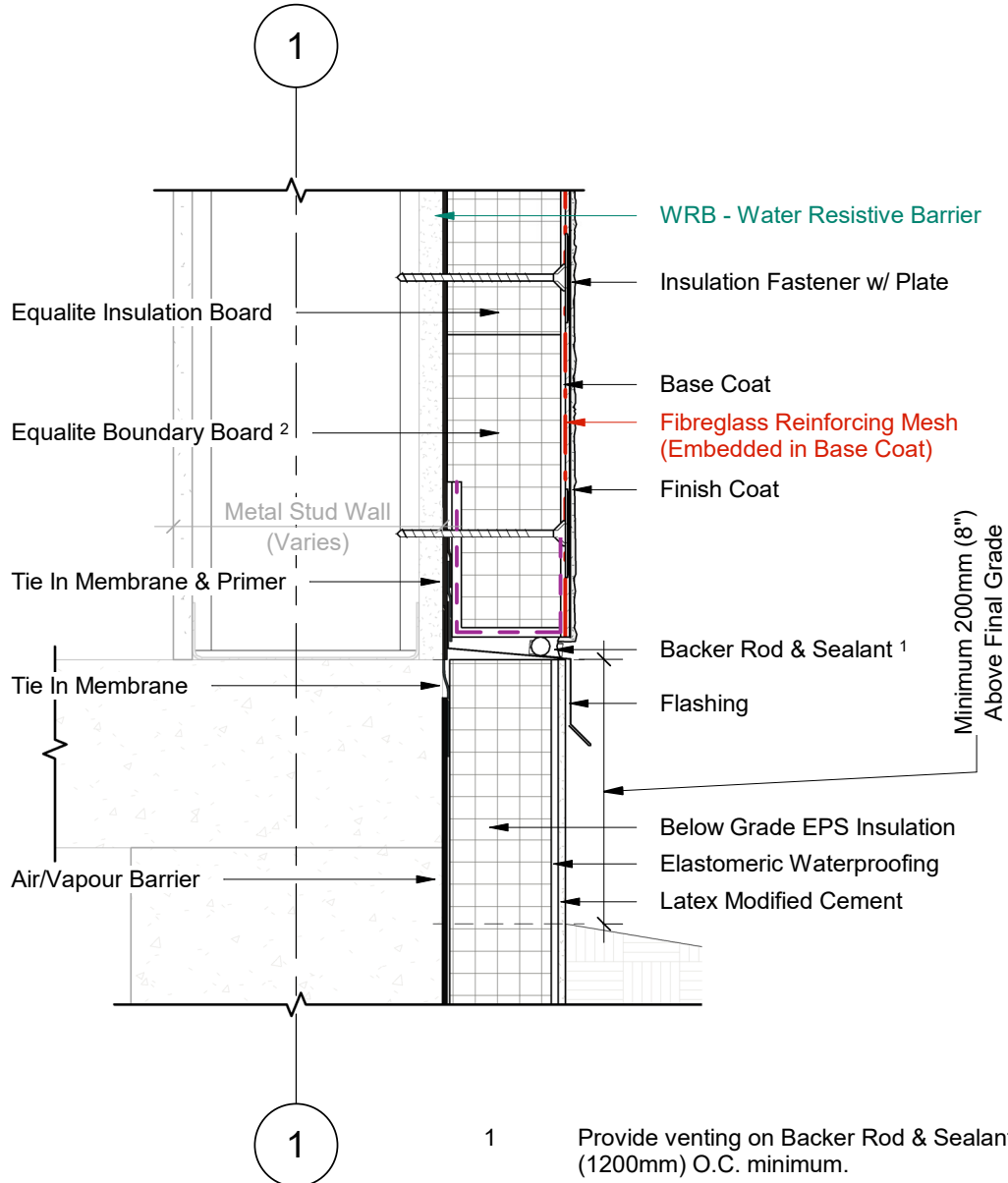

1 Wall Section
2 Scale = 1 : 5

- 1 Provide venting on Backer Rod & Sealant every 48" (1200mm) O.C. minimum.
- 2 Equalite Boundary Board includes a 4" (100mm) back wrapped mesh that is adhered to the board with a Base Coat layer.



Durabond details are offered to assist in the development of project specific details; principles and variables incorporated in all details are the sole responsibility of the project professional(s).

VERTICAL CLADDING CHANGE

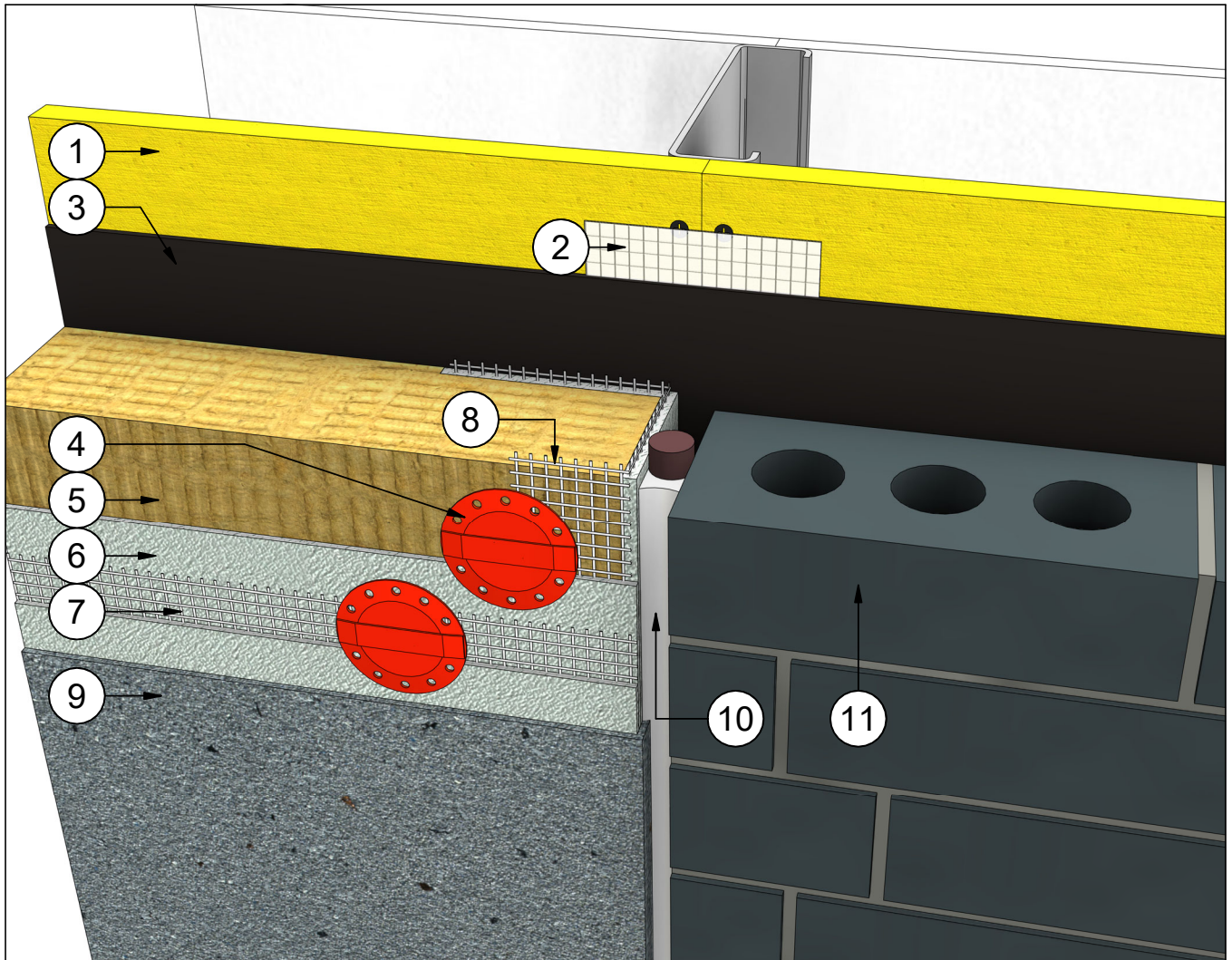

- | # | Note Text |
|----|---|
| 1 | Steel Studs Frame & Sheathing |
| 2 | Barrier Seam Tape (Embedded in WRB) |
| 3 | WRB - Water Resistive Barrier |
| 4 | Insulation Fastener w/ Plate |
| 5 | Equalite Insulation Board |
| 6 | Base Coat |
| 7 | Fibreglass Reinforcing Mesh (Embedded in Base Coat) |
| 8 | Fibreglass Reinforcing Mesh (Embedded in Base Coat) |
| 9 | Finish Coat |
| 10 | Backer Rod & Sealant |
| 11 | Alternate Cladding |

DURABOND.

Durabond details are offered to assist in the development of project specific details; principles and variables incorporated in all details are the sole responsibility of the project professional(s).

VERTICAL CLADDING CHANGE

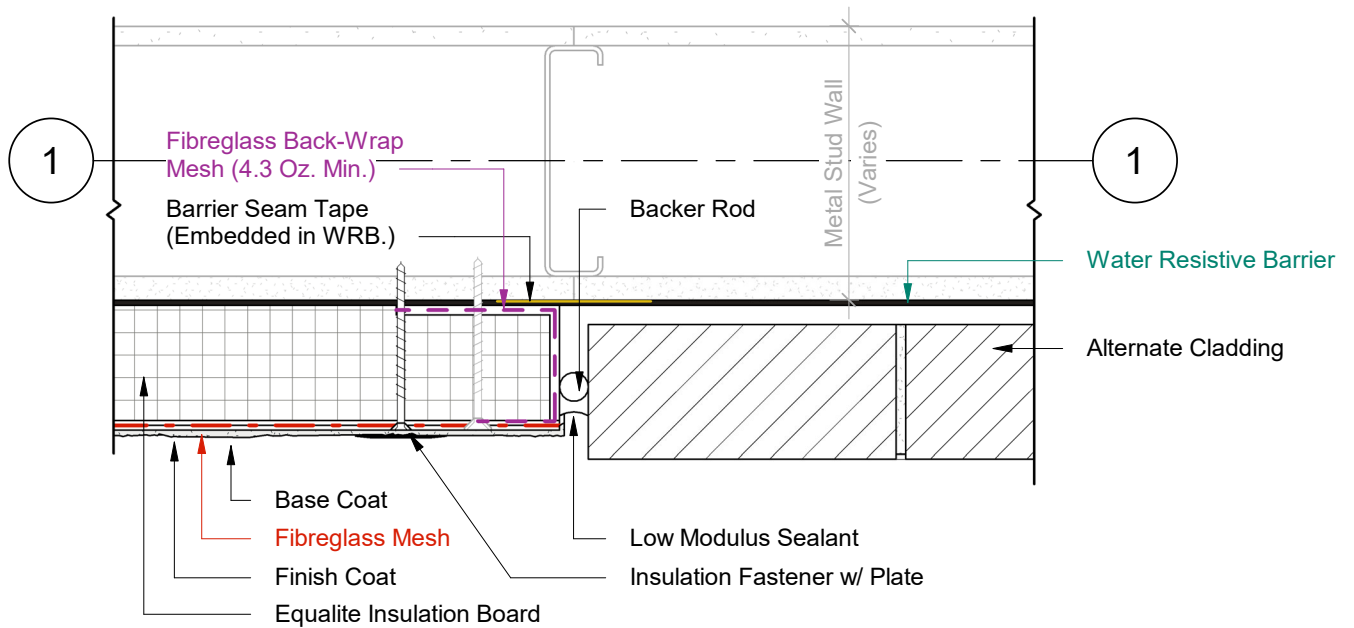

1 Plan Detail
2 Scale = 1:5



Durabond details are offered to assist in the development of project specific details; principles and variables incorporated in all details are the sole responsibility of the project professional(s).

WINDOW HEAD (OPTION A)

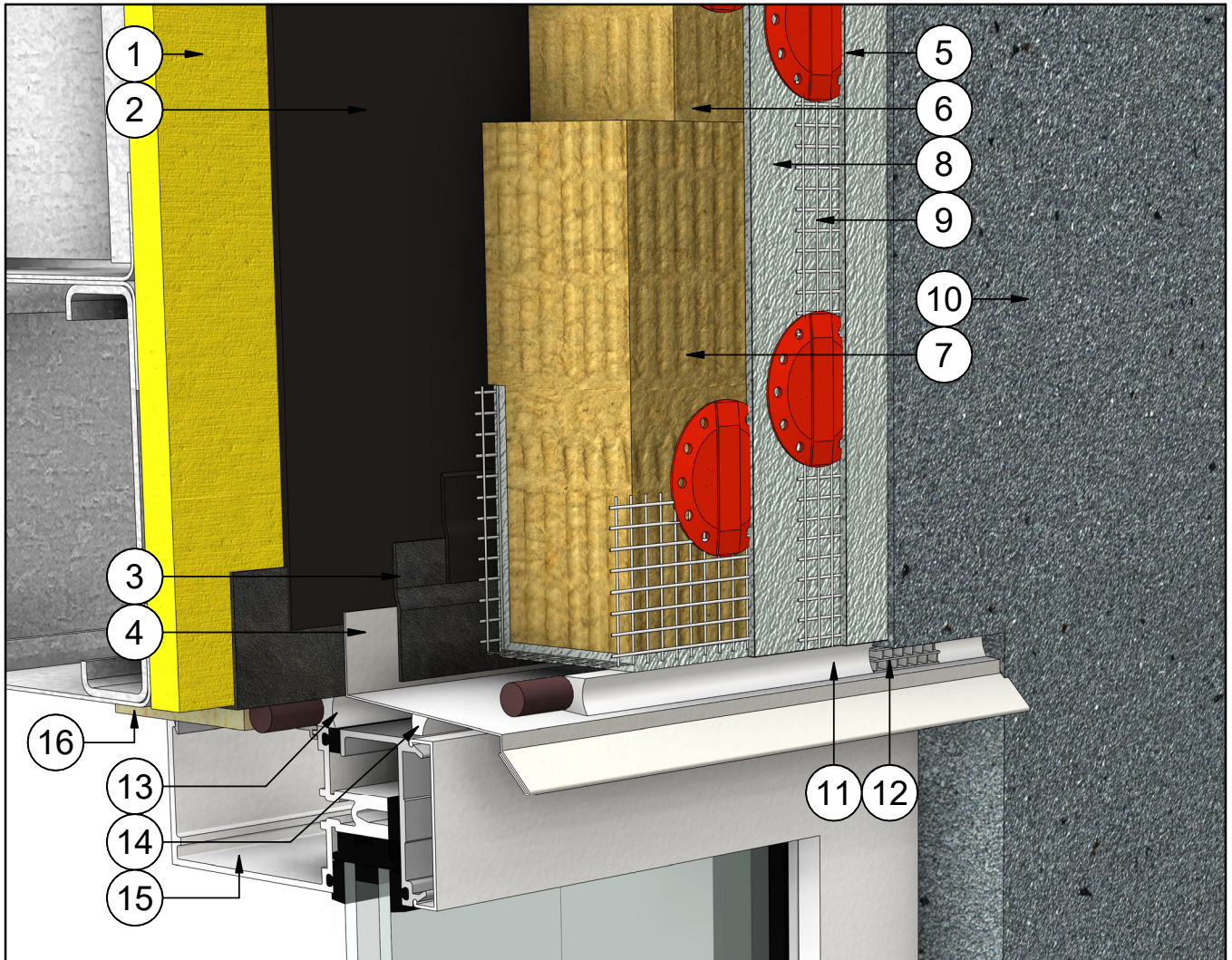

| # | Note Text | # | Note Text |
|---|---|----|-------------------------|
| 1 | Steel Studs Frame & Sheathing | 7 | Equalite Boundary Board |
| 2 | WRB - Water Resistant Barrier | 10 | Finish Coat |
| 3 | Tie In Membrane & Primer | 11 | Backer Rod & Sealant |
| 4 | Flashing w/ End Dams | 12 | Sealant Vent |
| 5 | Insulation Fastener w/ Plate | 13 | Backer Rod & Sealant |
| 6 | Equalite Insulation Board | 14 | Sealant |
| 8 | Base Coat | 15 | Window Assembly |
| 9 | Fiberglass Reinforcing Mesh (Embedded in Base Coat) | 16 | Wood Blocking |

DURABOND.

Durabond details are offered to assist in the development of project specific details; principles and variables incorporated in all details are the sole responsibility of the project professional(s).

WINDOW HEAD (OPTION A)

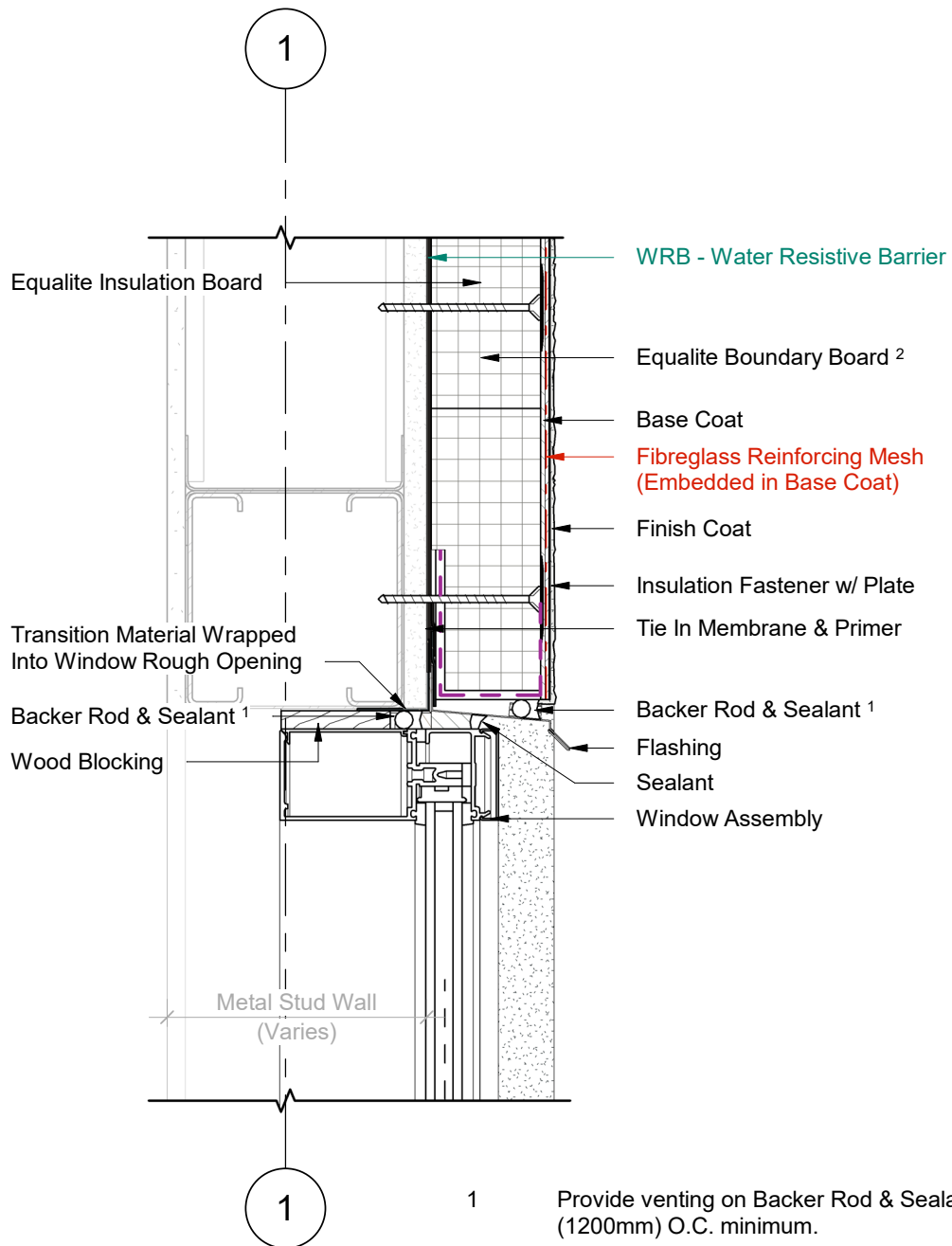

1 Wall Section
2 Scale = 1 : 5

- 1 Provide venting on Backer Rod & Sealant every 48" (1200mm) O.C. minimum.
- 2 Equalite Boundary Board includes a 4" (100mm) back wrapped mesh that is adhered to the board with a Base Coat layer.



Durabond details are offered to assist in the development of project specific details; principles and variables incorporated in all details are the sole responsibility of the project professional(s).

WINDOW HEAD (OPTION A)

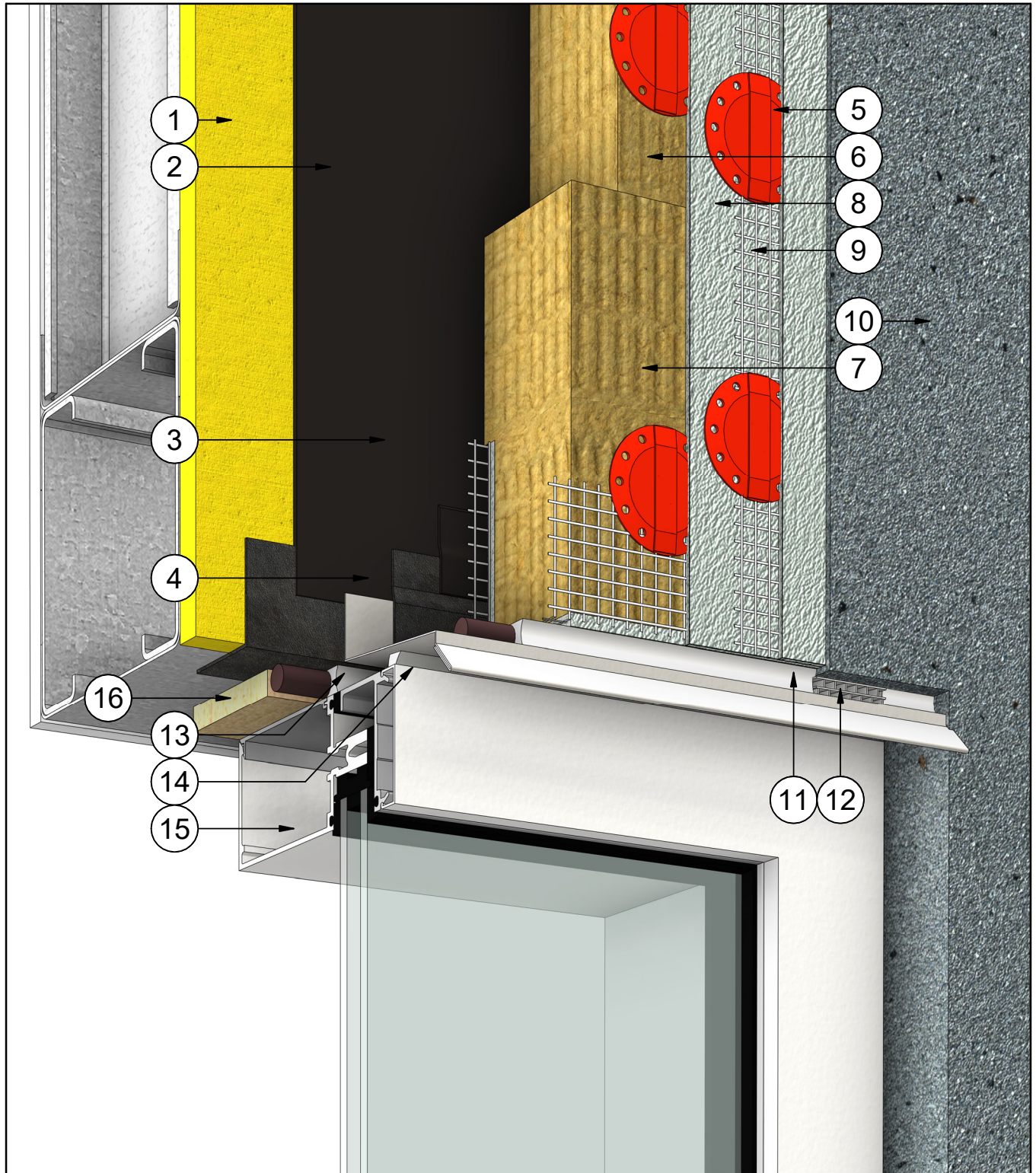

DURABOND.

Durabond details are offered to assist in the development of project specific details; principles and variables incorporated in all details are the sole responsibility of the project professional(s).

WINDOW SILL (OPTION A)

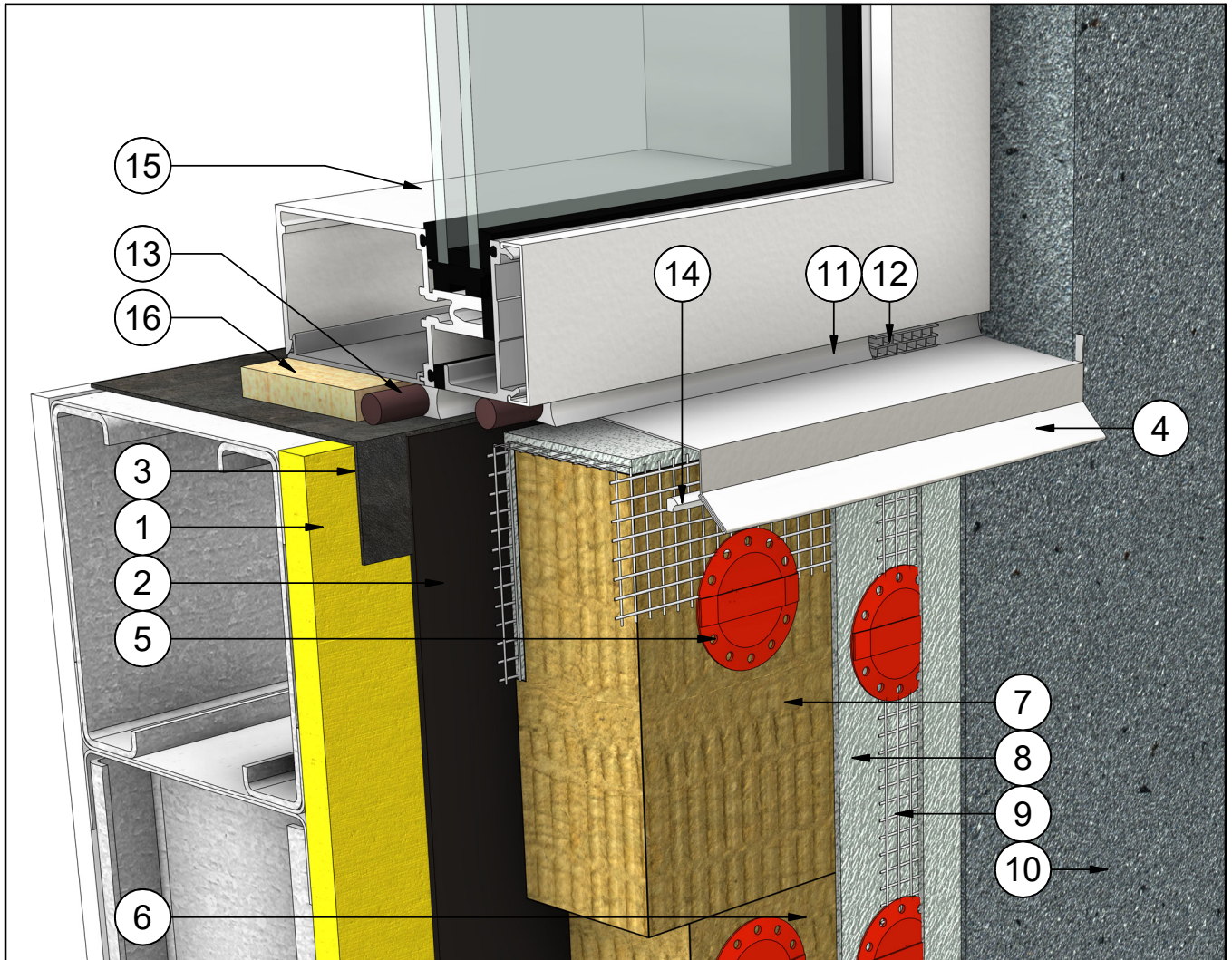

| # | Note Text | # | Note Text |
|---|---|----|----------------------|
| 1 | Steel Studs Frame & Sheathing | 10 | Finish Coat |
| 2 | WRB - Water Resistant Barrier | 11 | Backer Rod & Sealant |
| 3 | Transition Membrane | 12 | Sealant Vent |
| 4 | Flashing w/ End Dams | 13 | Backer Rod & Sealant |
| 5 | Insulation Fastener w/ Plate | 14 | Sealant |
| 6 | Equalite Insulation Board | 15 | Window Assembly |
| 7 | Equalite Boundary Board | 16 | Wood Blocking |
| 8 | Base Coat | | |
| 9 | Fiberglass Reinforcing Mesh (Embedded in Base Coat) | | |



Durabond details are offered to assist in the development of project specific details; principles and variables incorporated in all details are the sole responsibility of the project professional(s).

WINDOW SILL (OPTION A)

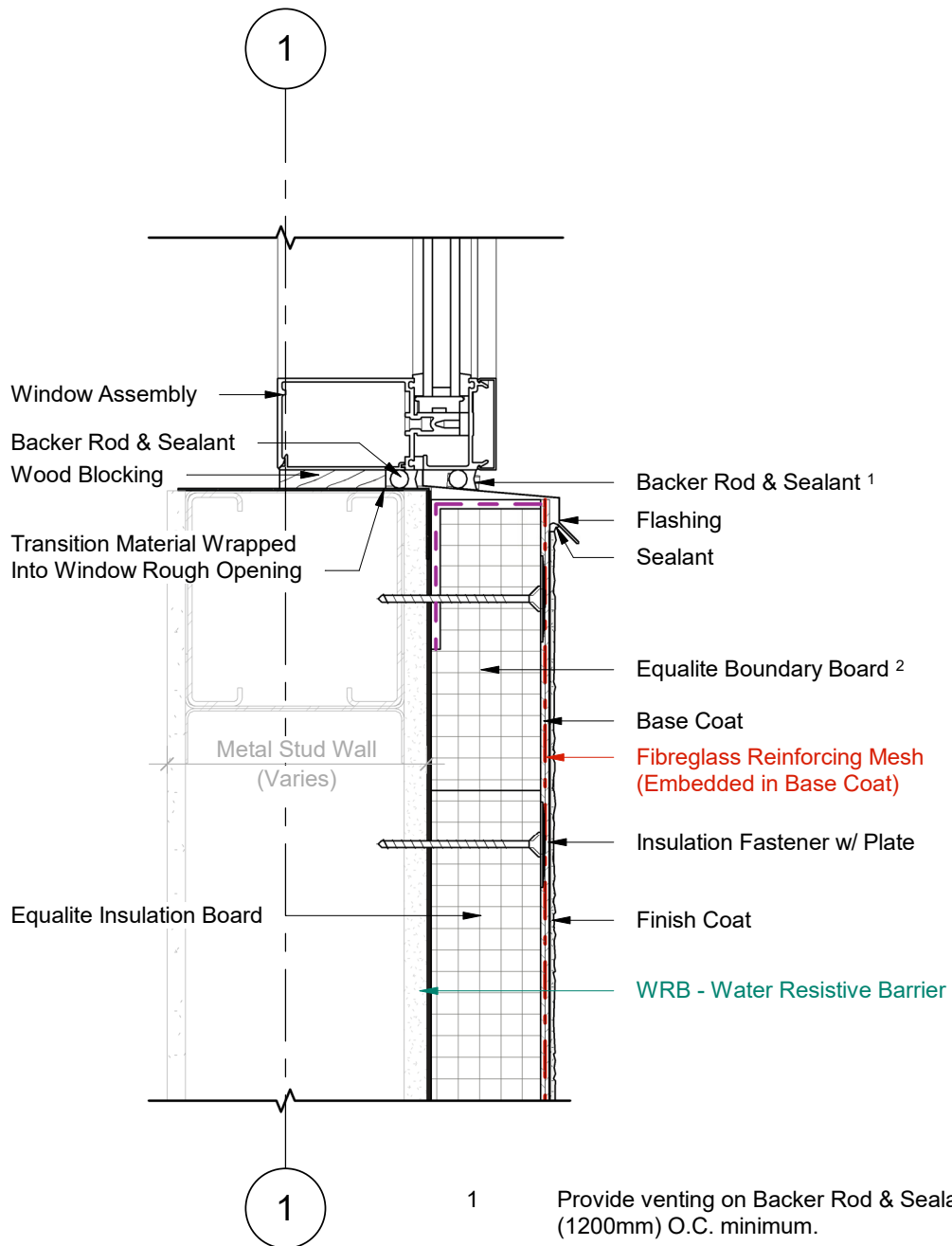

1 Wall Section
2 Scale = 1 : 5

- 1 Provide venting on Backer Rod & Sealant every 48" (1200mm) O.C. minimum.
- 2 Equalite Boundary Board includes a 4" (100mm) back wrapped mesh that is adhered to the board with a Base Coat layer.



Durabond details are offered to assist in the development of project specific details; principles and variables incorporated in all details are the sole responsibility of the project professional(s).

WINDOW SILL (OPTION A)

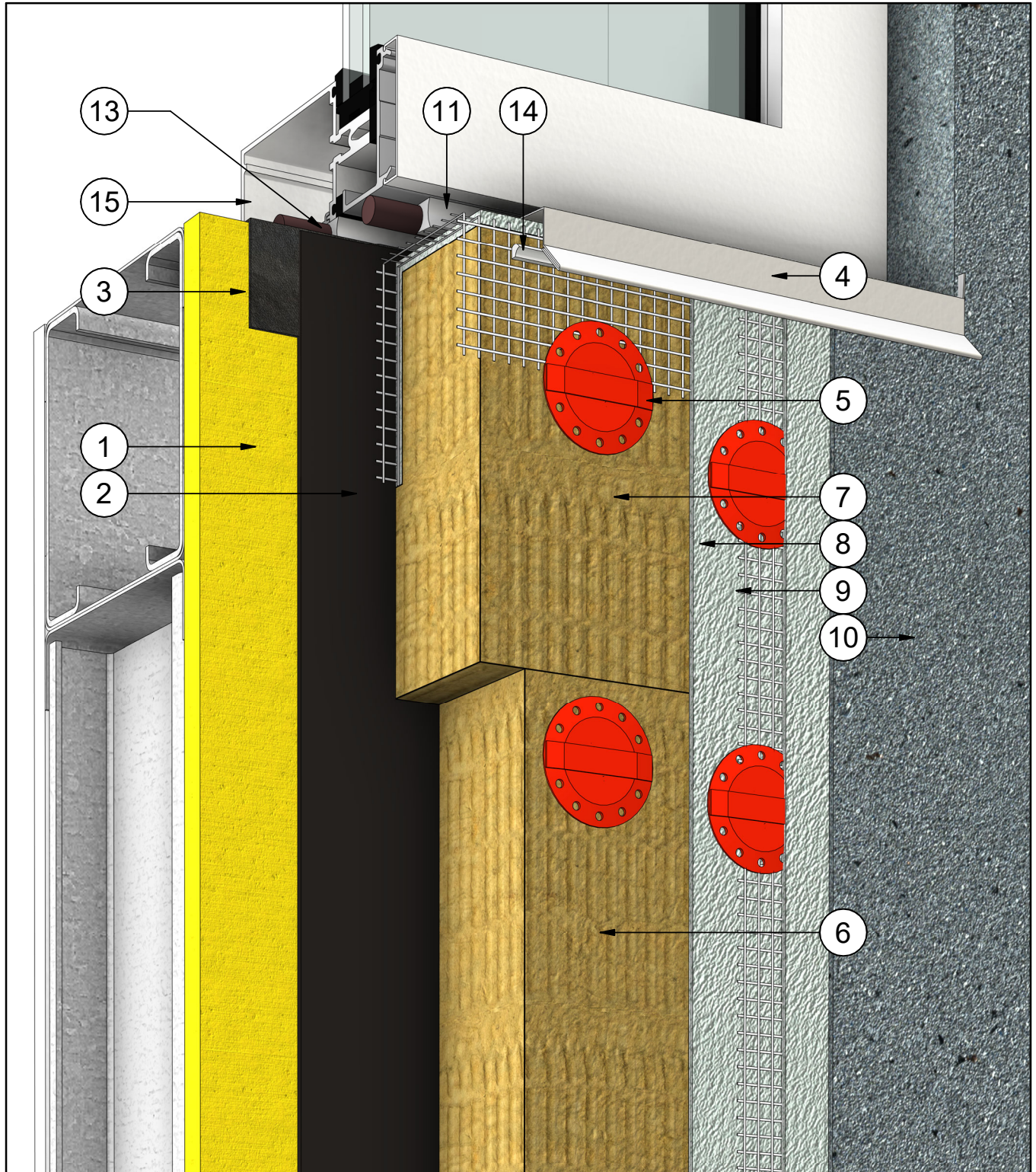

DURABOND.

Durabond details are offered to assist in the development of project specific details; principles and variables incorporated in all details are the sole responsibility of the project professional(s).

WINDOW JAMB (OPTION A)

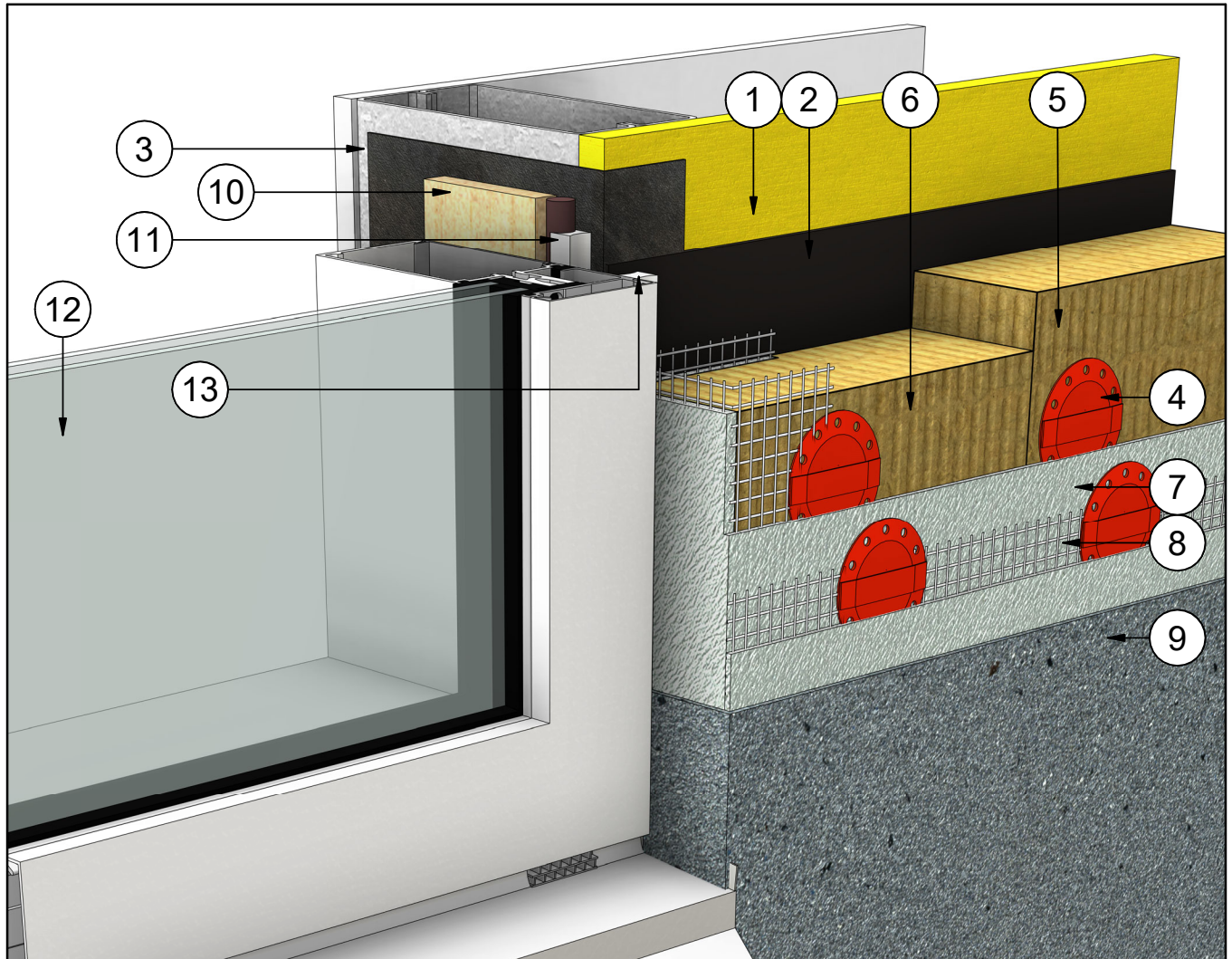

| # | Note Text | # | Note Text |
|---|---|----|----------------------|
| 1 | Steel Studs Frame & Sheathing | 9 | Finish Coat |
| 2 | WRB - Water Resistant Barrier | 10 | Wood Blocking |
| 3 | Transition Membrane | 11 | Backer Rod & Sealant |
| 4 | Insulation Fastener w/ Plate | 12 | Window Assembly |
| 5 | Equalite Insulation Board | 13 | Sealant |
| 6 | Equalite Boundary Board | | |
| 7 | Base Coat | | |
| 8 | Fiberglass Reinforcing Mesh (Embedded in Base Coat) | | |

DURABOND.

Durabond details are offered to assist in the development of project specific details; principles and variables incorporated in all details are the sole responsibility of the project professional(s).

WINDOW JAMB (OPTION A)

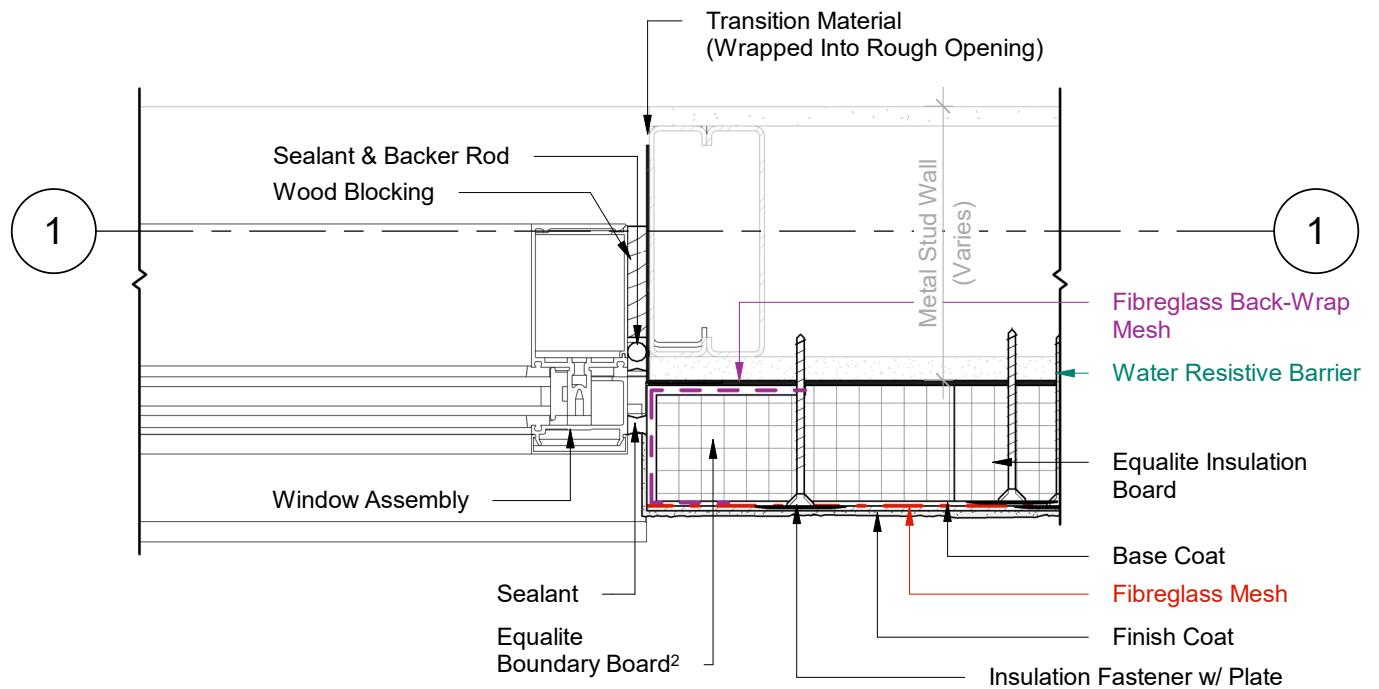

1 Plan Detail
2 Scale = 1:5

- 1 Provide venting on Backer Rod & Sealant every 48" (1200mm) O.C. minimum.
- 2 Equalite Boundary Board includes a 4" (100mm) back wrapped mesh that is adhered to the board with a Base Coat layer.



Durabond details are offered to assist in the development of project specific details; principles and variables incorporated in all details are the sole responsibility of the project professional(s).

WINDOW JAMB (OPTION A)

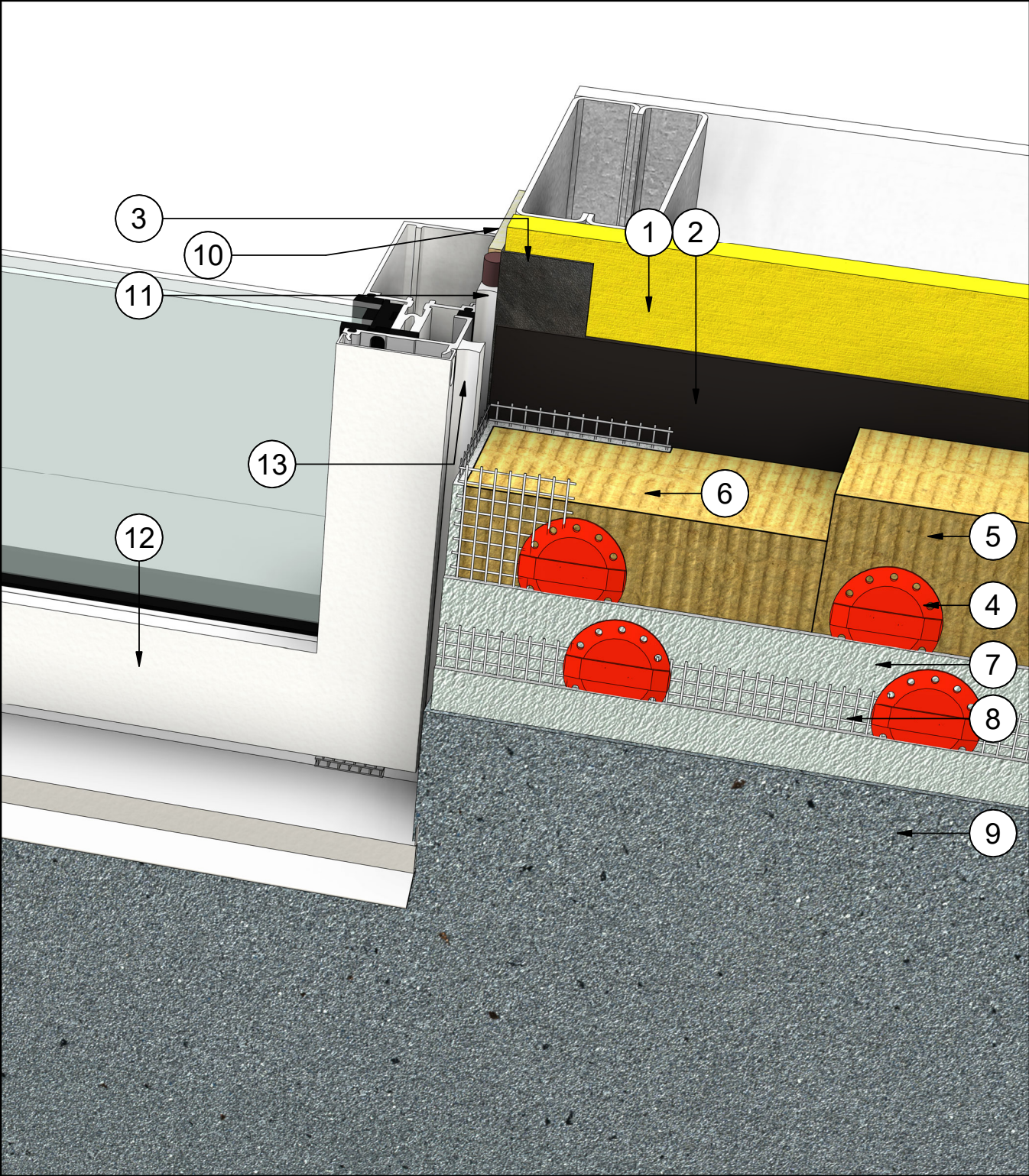

DURABOND.

Durabond details are offered to assist in the development of project specific details; principles and variables incorporated in all details are the sole responsibility of the project professional(s).

WINDOW HEAD (OPTION B)

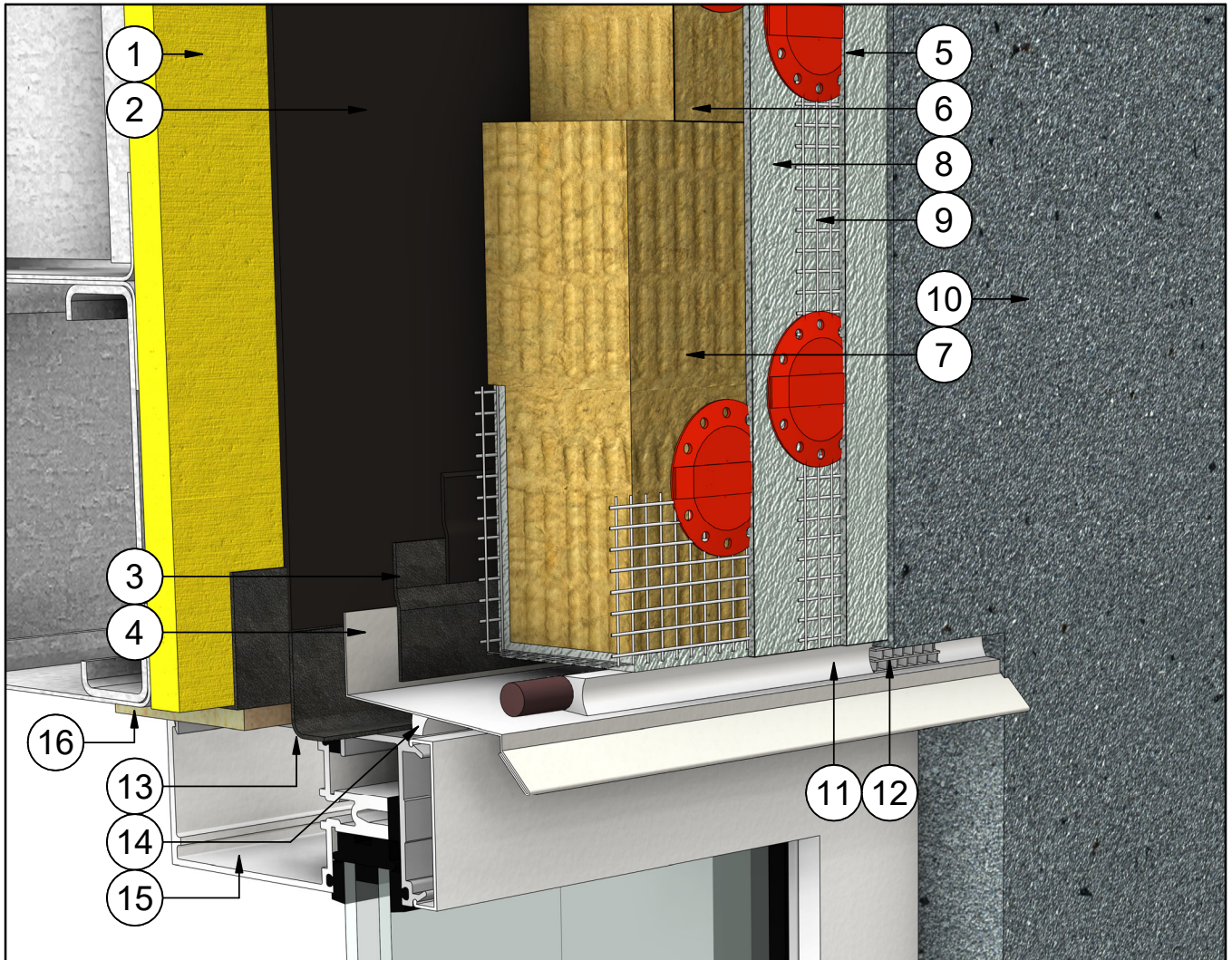

| # | Note Text | # | Note Text |
|---|---|----|-------------------------|
| 1 | Steel Studs Frame & Sheathing | 7 | Equalite Boundary Board |
| 2 | WRB - Water Resistant Barrier | 10 | Finish Coat |
| 3 | Tie In Membrane & Primer | 11 | Backer Rod & Sealant |
| 4 | Flashing w/ End Dams | 12 | Sealant Vent |
| 5 | Insulation Fastener w/ Plate | 13 | Transition Membrane |
| 6 | Equalite Insulation Board | 14 | Sealant |
| 8 | Base Coat | 15 | Window Assembly |
| 9 | Fibreglass Reinforcing Mesh (Embedded in Base Coat) | 16 | Wood Blocking |

DURABOND.

Durabond details are offered to assist in the development of project specific details; principles and variables incorporated in all details are the sole responsibility of the project professional(s).

WINDOW HEAD (OPTION B)

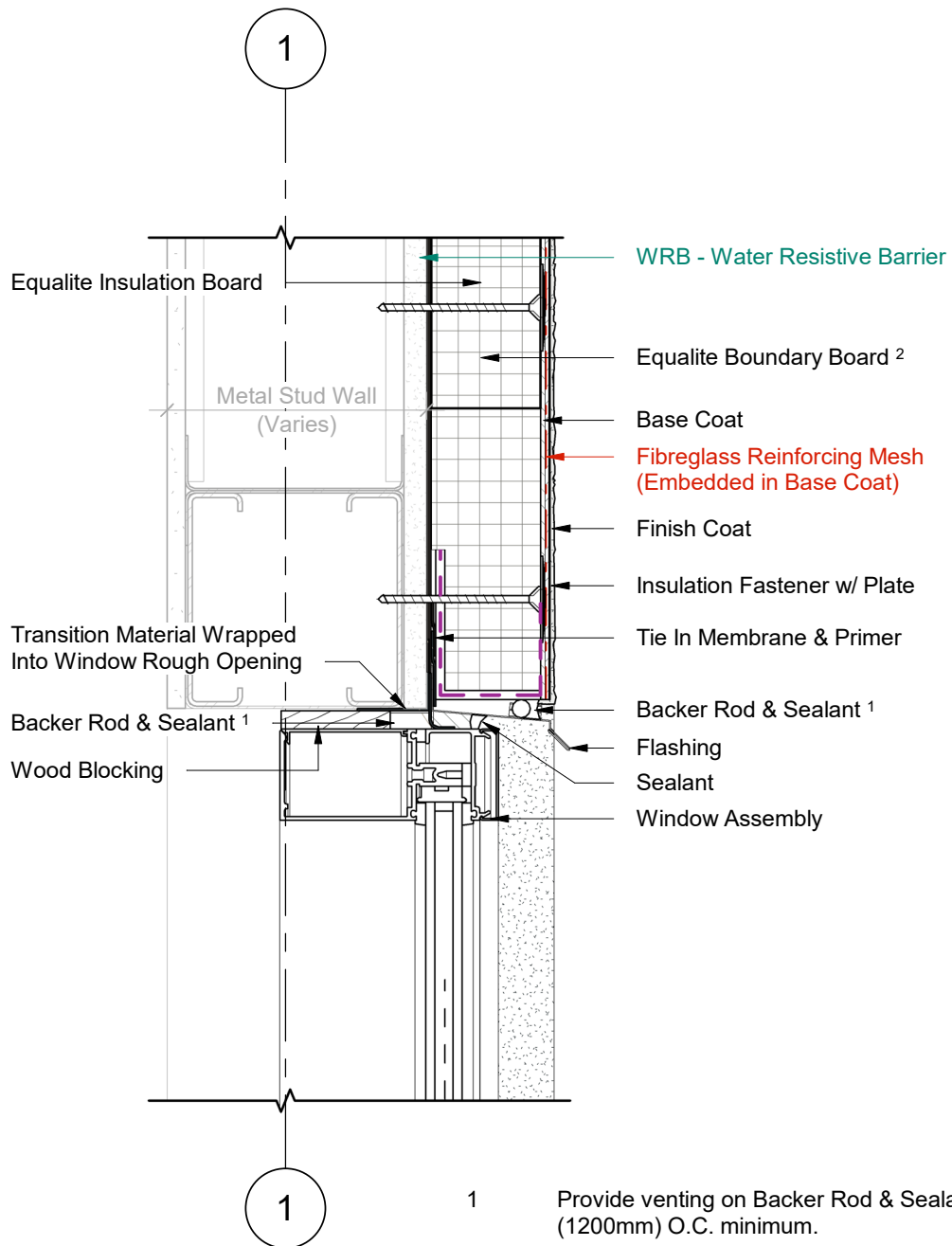

1 Wall Section
2 Scale = 1 : 5

- 1 Provide venting on Backer Rod & Sealant every 48" (1200mm) O.C. minimum.
- 2 Equalite Boundary Board includes a 4" (100mm) back wrapped mesh that is adhered to the board with a Base Coat layer.



Durabond details are offered to assist in the development of project specific details; principles and variables incorporated in all details are the sole responsibility of the project professional(s).

WINDOW HEAD (OPTION B)

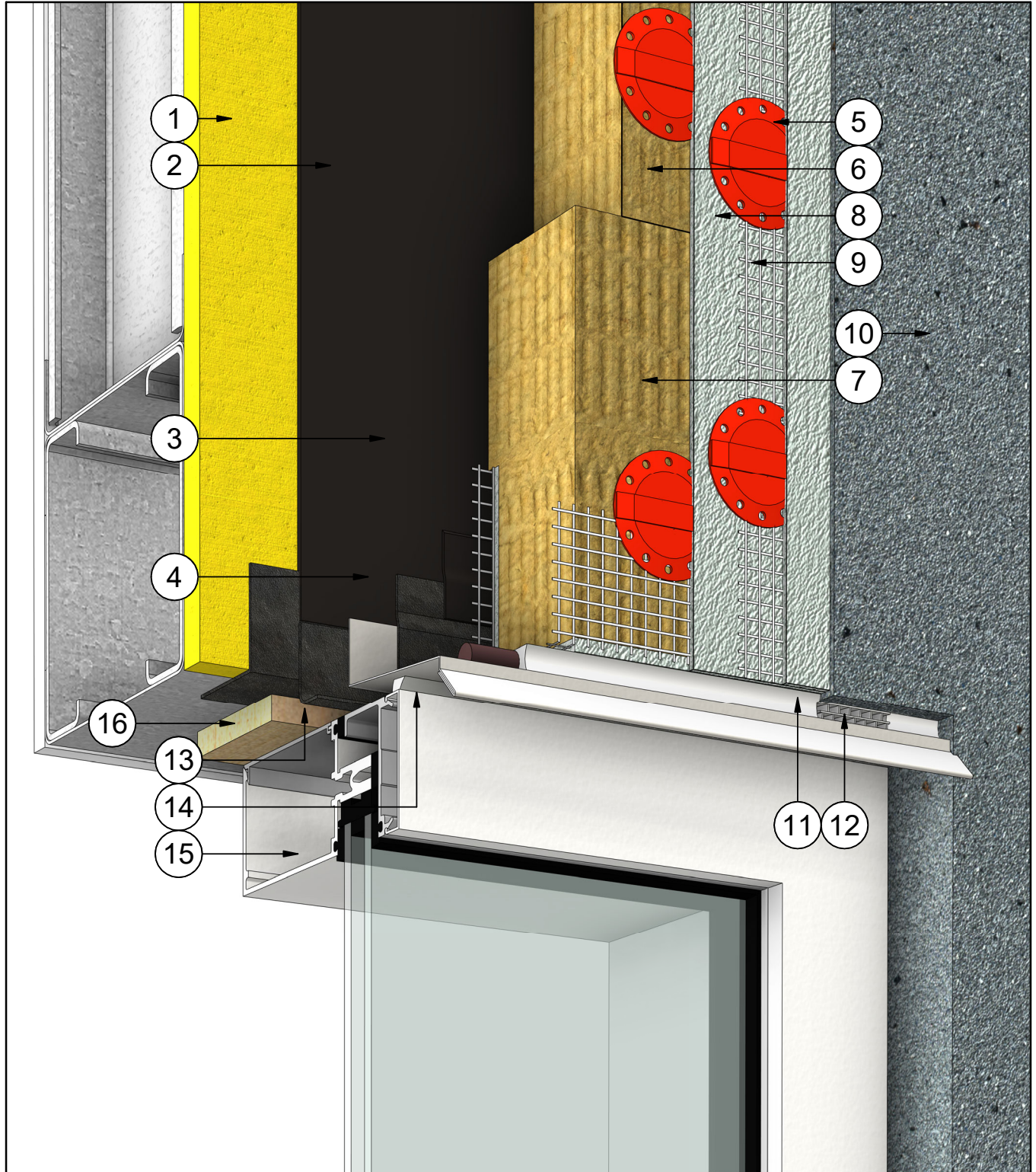

DURABOND.

Durabond details are offered to assist in the development of project specific details; principles and variables incorporated in all details are the sole responsibility of the project professional(s).

WINDOW SILL (OPTION B)

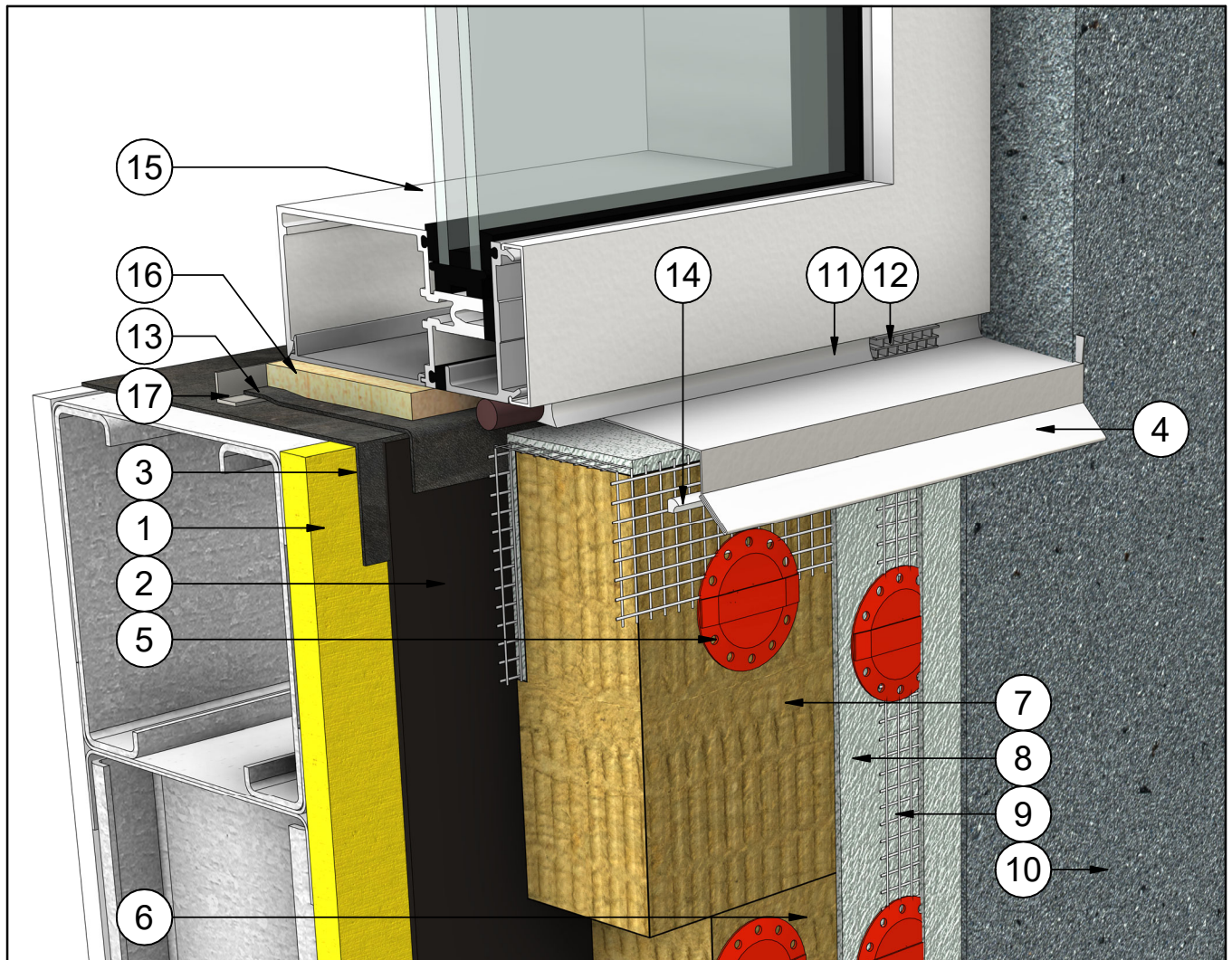

| # | Note Text | # | Note Text |
|---|---|----|----------------------|
| 1 | Steel Studs Frame & Sheathing | 10 | Finish Coat |
| 2 | WRB - Water Resistant Barrier | 11 | Backer Rod & Sealant |
| 3 | Transition Membrane | 12 | Sealant Vent |
| 4 | Flashing w/ End Dams | 13 | Transition Membrane |
| 5 | Insulation Fastener w/ Plate | 14 | Sealant |
| 6 | Equalite Insulation Board | 15 | Window Assembly |
| 7 | Equalite Boundary Board | 16 | Wood Blocking |
| 8 | Base Coat | 17 | Drip Deflector |
| 9 | Fiberglass Reinforcing Mesh (Embedded in Base Coat) | | |

DURABOND.

Durabond details are offered to assist in the development of project specific details; principles and variables incorporated in all details are the sole responsibility of the project professional(s).

WINDOW SILL (OPTION B)

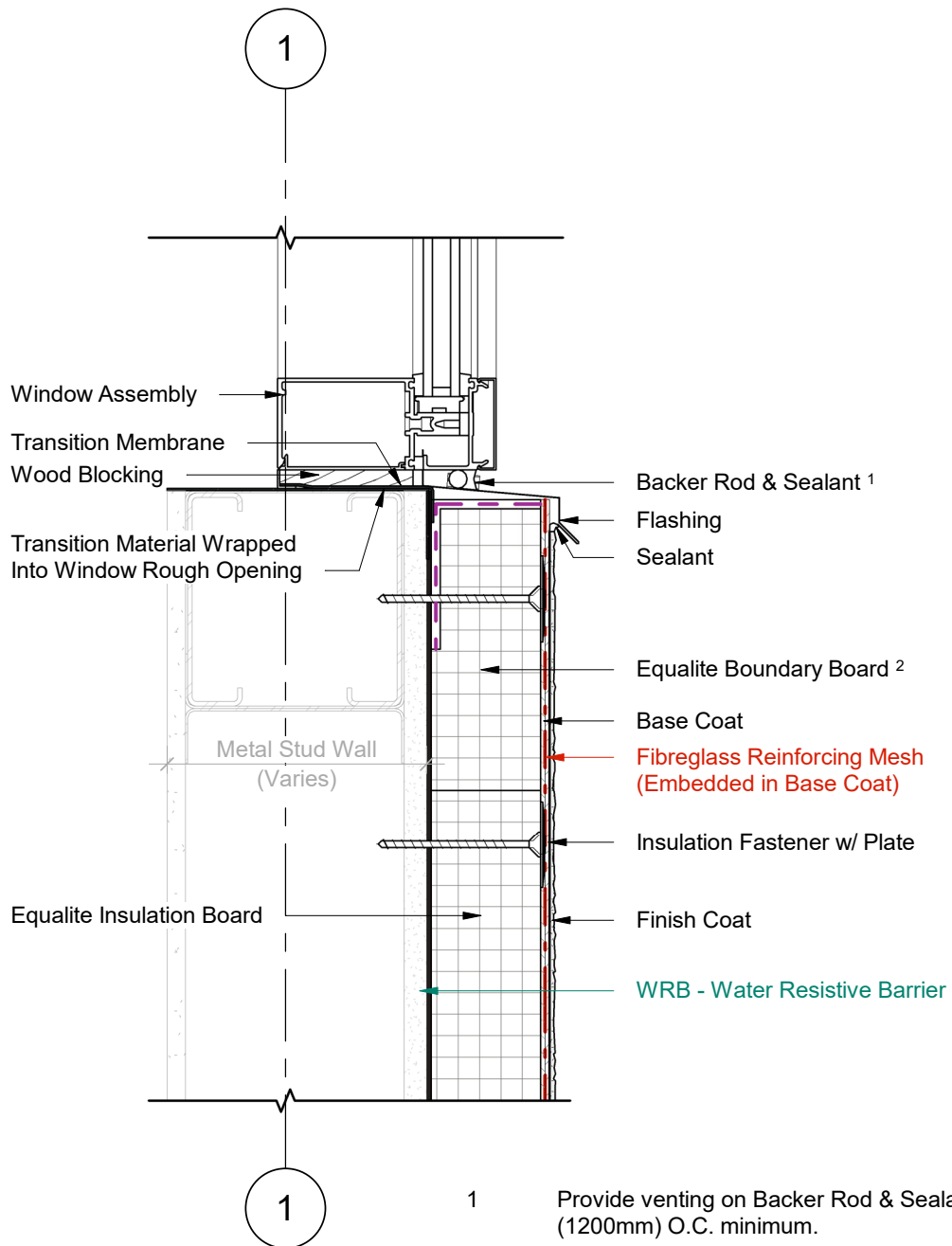

1 Wall Section
2 Scale = 1 : 5

- 1 Provide venting on Backer Rod & Sealant every 48" (1200mm) O.C. minimum.
- 2 Equalite Boundary Board includes a 4" (100mm) back wrapped mesh that is adhered to the board with a Base Coat layer.



Durabond details are offered to assist in the development of project specific details; principles and variables incorporated in all details are the sole responsibility of the project professional(s).

WINDOW SILL (OPTION B)

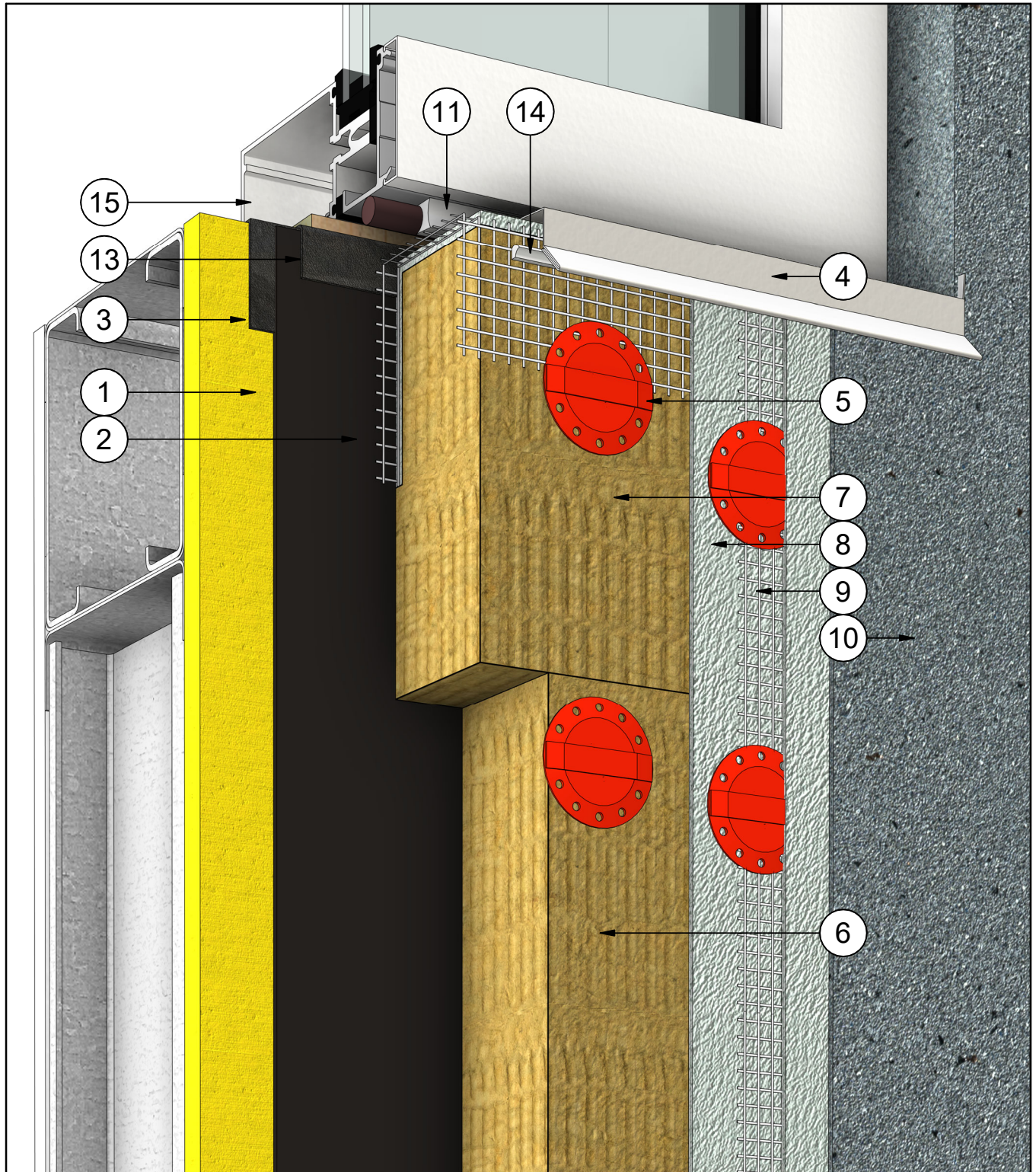

DURabond.

Durabond details are offered to assist in the development of project specific details; principles and variables incorporated in all details are the sole responsibility of the project professional(s).

WINDOW JAMB (OPTION B)

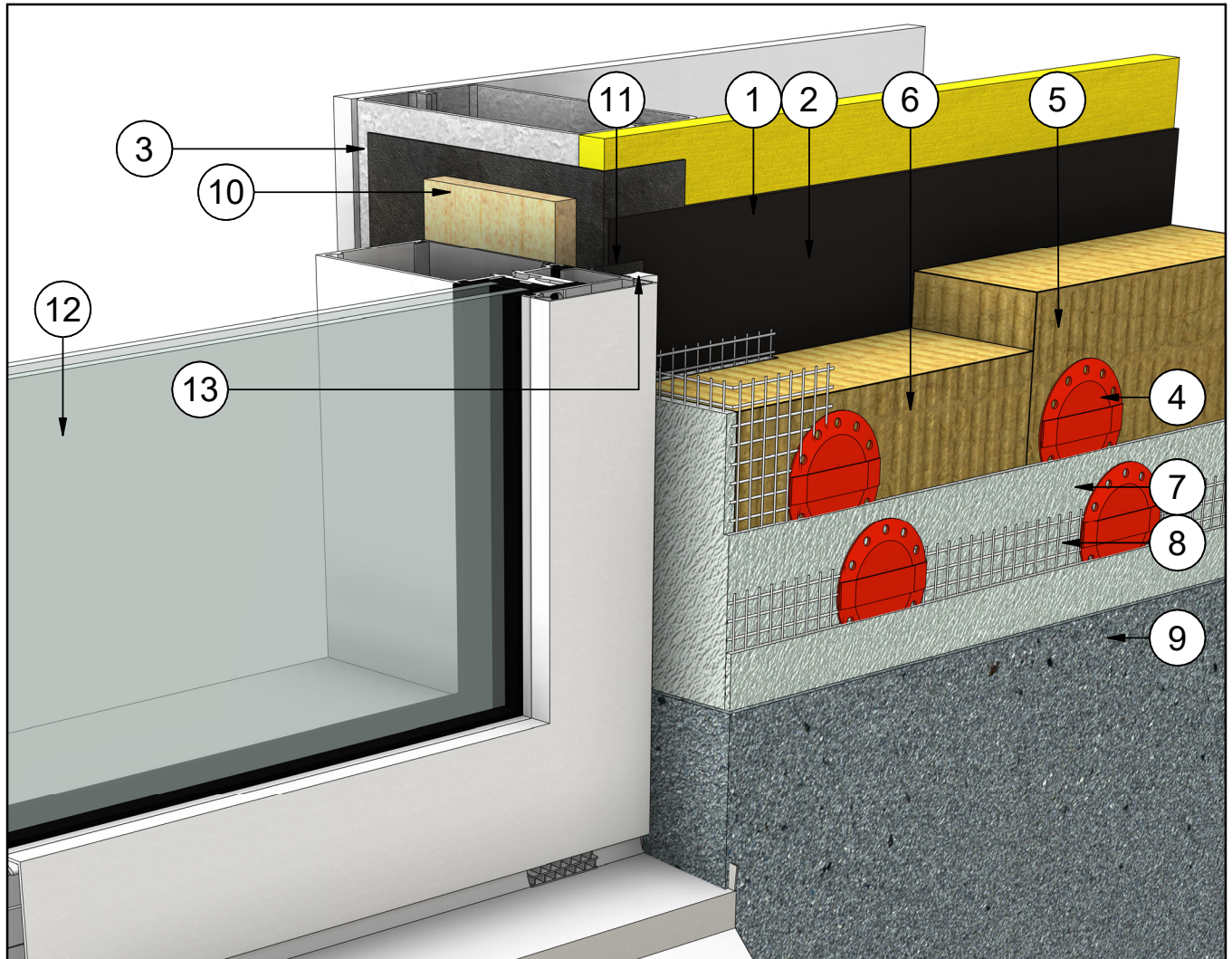

| # | Note Text | # | Note Text |
|---|---|----|---------------------|
| 1 | Steel Studs Frame & Sheathing | 9 | Finish Coat |
| 2 | WRB - Water Resistant Barrier | 10 | Wood Blocking |
| 3 | Transition Membrane | 11 | Transition Membrane |
| 4 | Insulation Fastener w/ Plate | 12 | Window Assembly |
| 5 | Equalite Insulation Board | 13 | Sealant |
| 6 | Equalite Boundary Board | | |
| 7 | Base Coat | | |
| 8 | Fiberglass Reinforcing Mesh (Embedded in Base Coat) | | |

DURABOND.

Durabond details are offered to assist in the development of project specific details; principles and variables incorporated in all details are the sole responsibility of the project professional(s).

WINDOW JAMB (OPTION B)

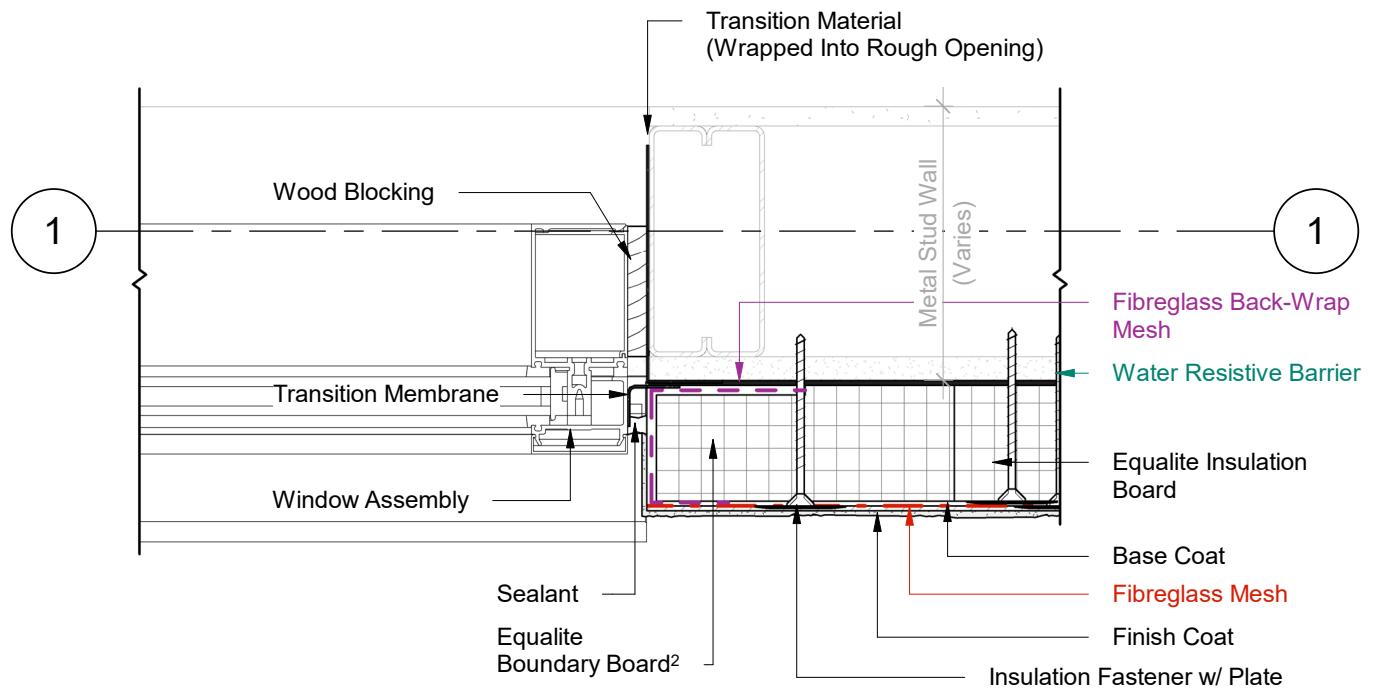

1 Plan Detail
2 Scale = 1:5

- 1 Provide venting on Backer Rod & Sealant every 48" (1200mm) O.C. minimum.
- 2 Equalite Boundary Board includes a 4" (100mm) back wrapped mesh that is adhered to the board with a Base Coat layer.



Durabond details are offered to assist in the development of project specific details; principles and variables incorporated in all details are the sole responsibility of the project professional(s).

WINDOW JAMB (OPTION B)

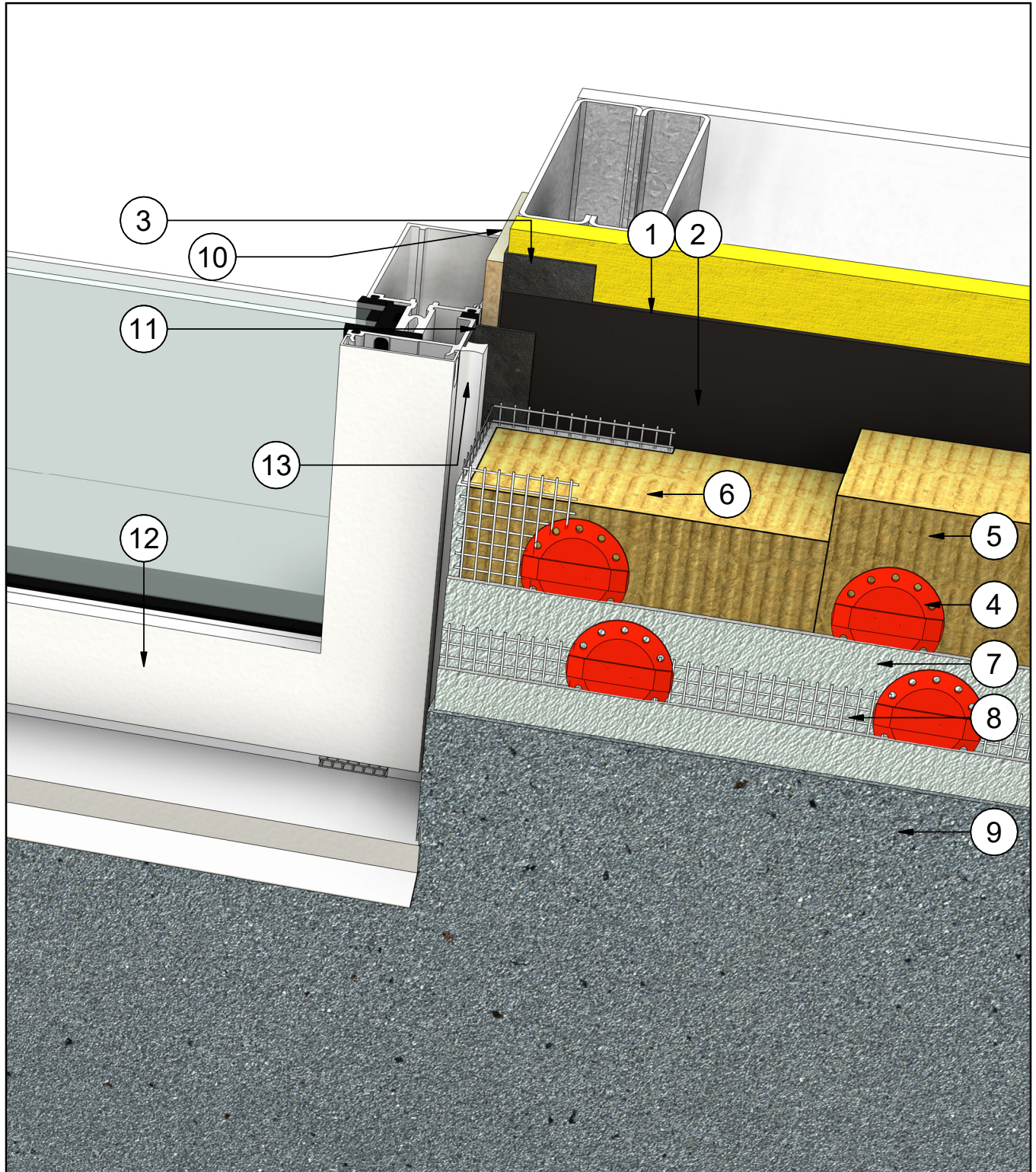

DURABOND.

Durabond details are offered to assist in the development of project specific details; principles and variables incorporated in all details are the sole responsibility of the project professional(s).

PARAPET DETAIL

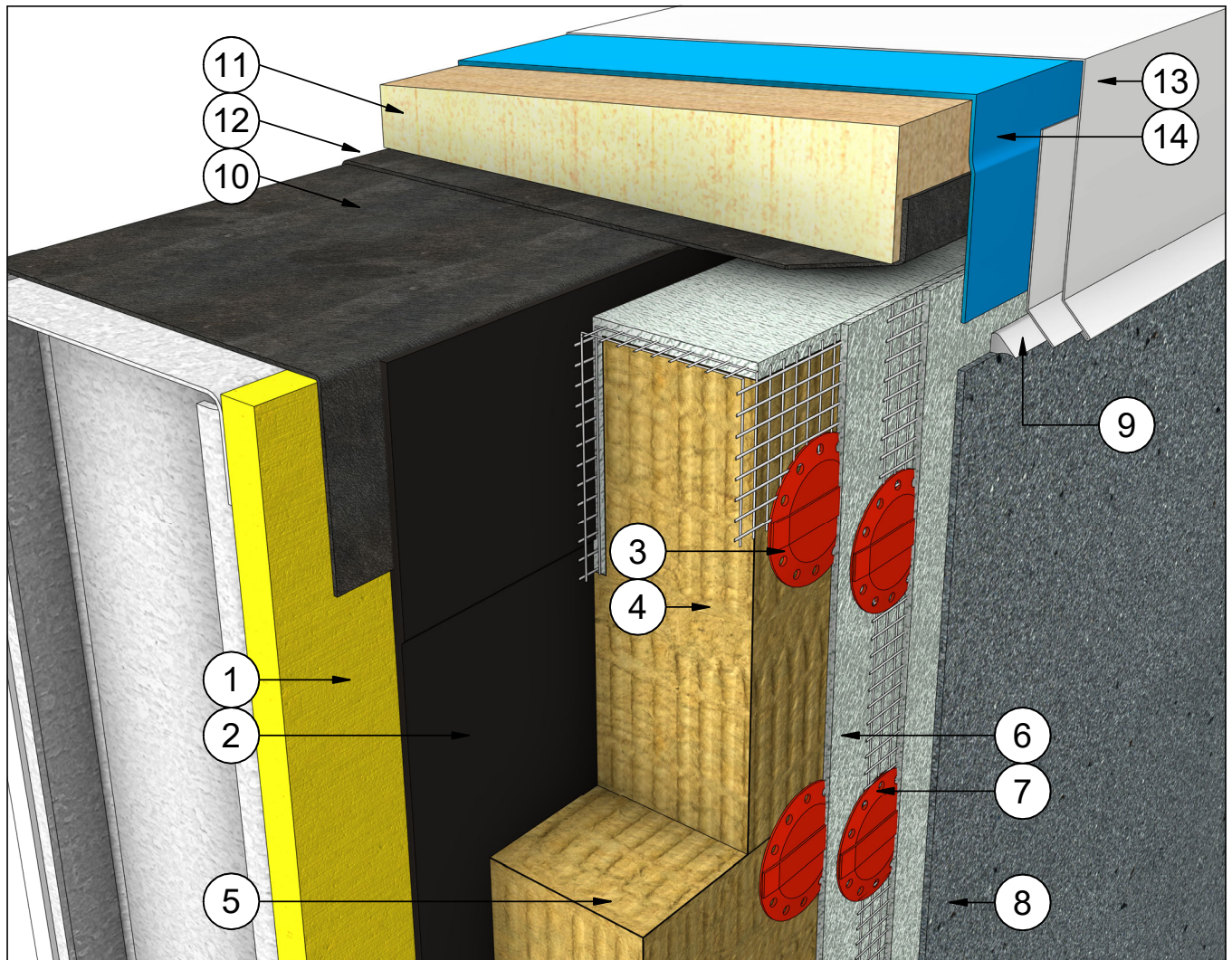

| # | Note Text | # | Note Text |
|---|---|----|--|
| 1 | Steel Studs Frame & Sheathing | 9 | Low Modulus Sealant |
| 2 | Water Resistive Barrier | 10 | Transition Material Over Wall Assembly |
| 3 | Insulation Fastener w/ Plate | 11 | Wood Blocking |
| 4 | Equalite Boundary Board | 12 | Transition Material from Back of Wall to Front of Wall |
| 5 | Equalite Insulation Board | 13 | Parapet Flashing & Counterflashing |
| 6 | Base Coat | 14 | Roof System Waterproof Membrane |
| 7 | Fibreglass Reinforcing Mesh (Embedded in Base Coat) | | |
| 8 | Finish Coat | | |

DURABOND.

Durabond details are offered to assist in the development of project specific details; principles and variables incorporated in all details are the sole responsibility of the project professional(s).

PARAPET DETAIL

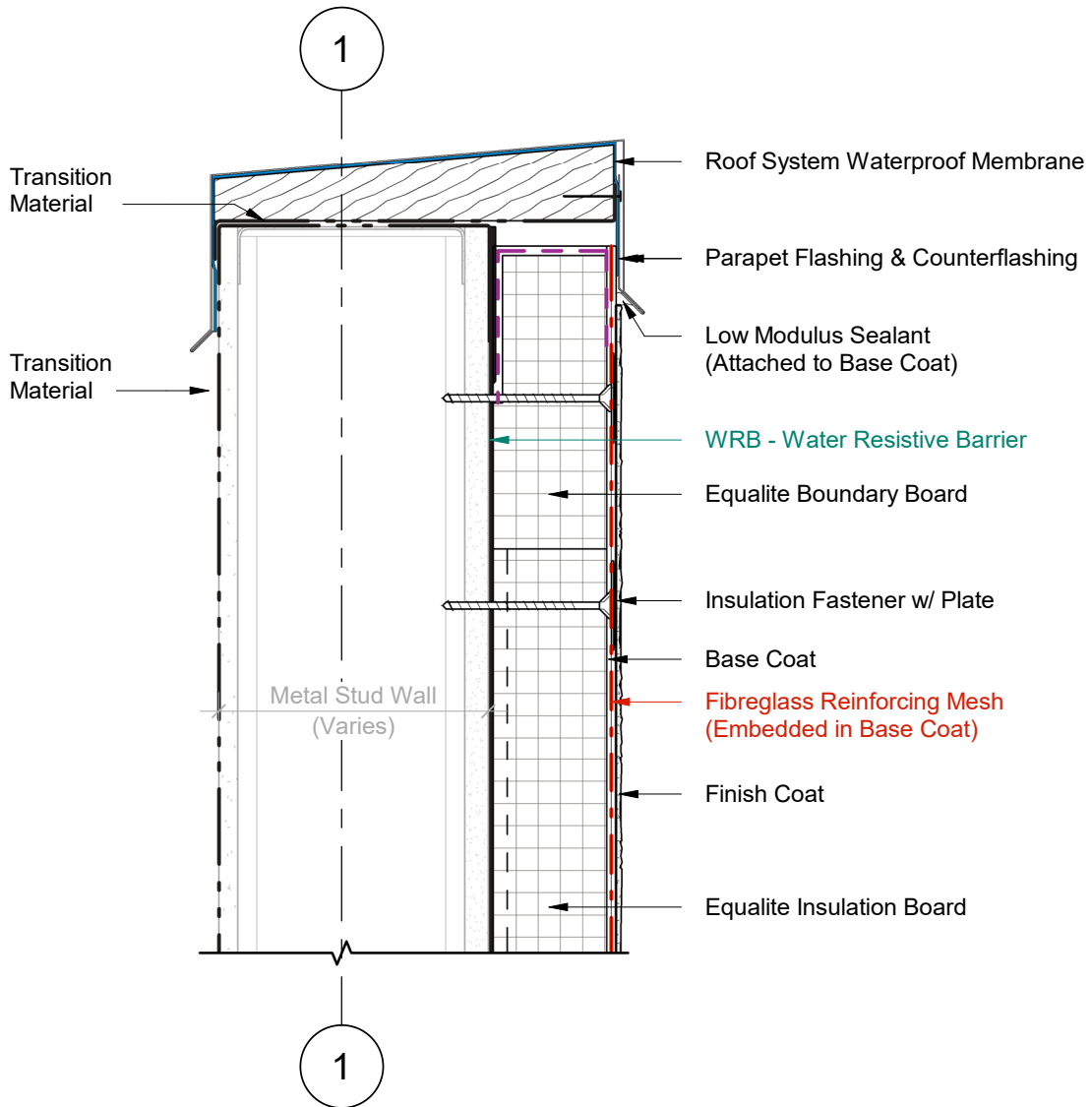

1 Wall Section
2 Scale = 1 : 5

PARAPET DETAIL

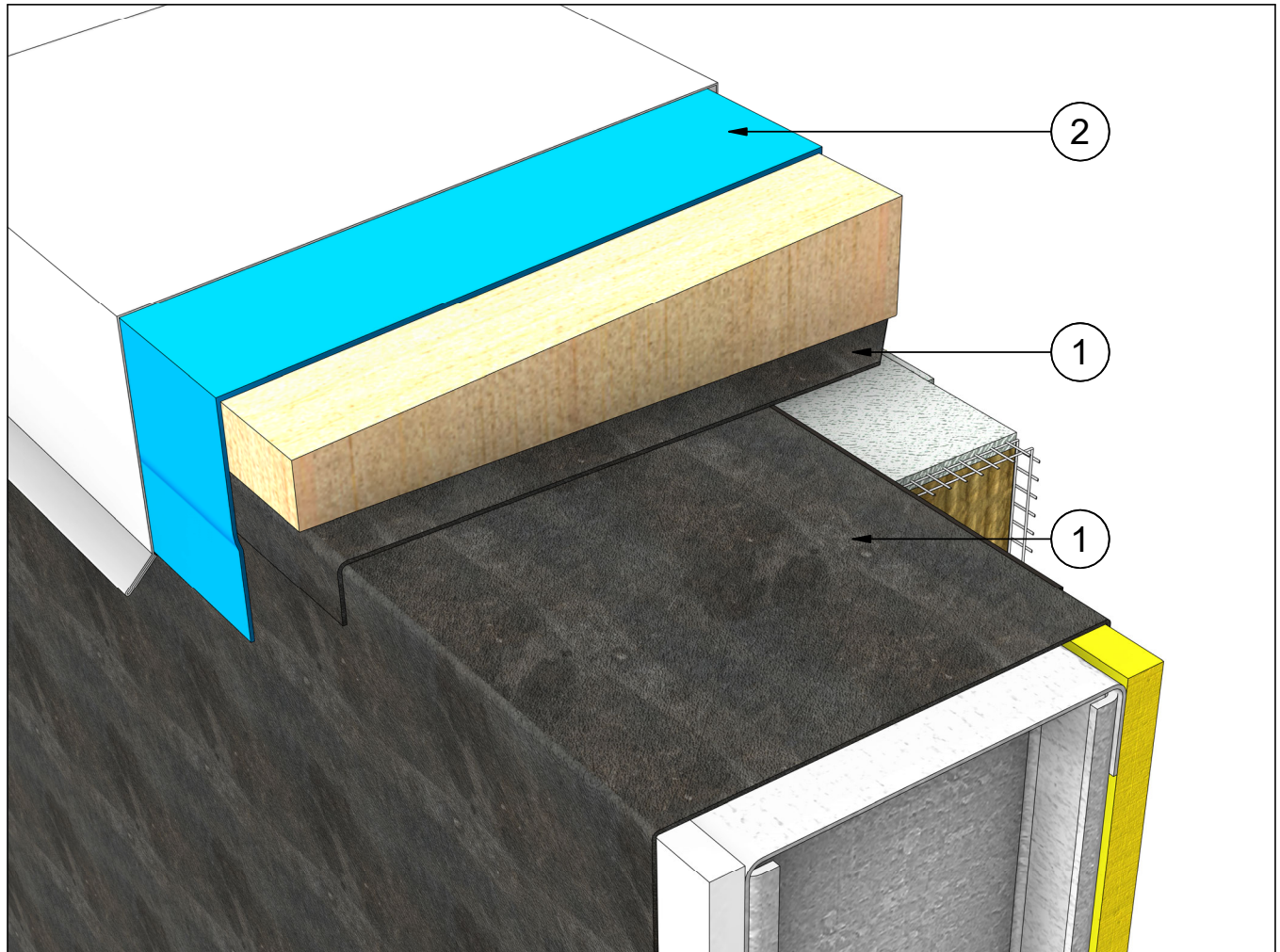

MEMBRANE SPECIFICS

1 Transition Material

There are two **transition membranes** needed to complete the parapet. The first membrane transitions between the backside of the wall and the water resistive barrier.

The second membrane then lines the bottom of the wood blocking. It gets overlapped on both sides of the wall by the **air & vapour barrier**. These two layers of transition material ensure that the drainage remains positive at both the front & back of the wall.

2 Roof System Waterproof Membrane

The roof waterproofing membrane, typically an air & vapour barrier, is located directly beneath the metal flashing. It wraps over the entirety of the wall and ensures that the parapet is protected from the elements.

DURABOND.

Durabond details are offered to assist in the development of project specific details; principles and variables incorporated in all details are the sole responsibility of the project professional(s).

PARAPET DETAIL

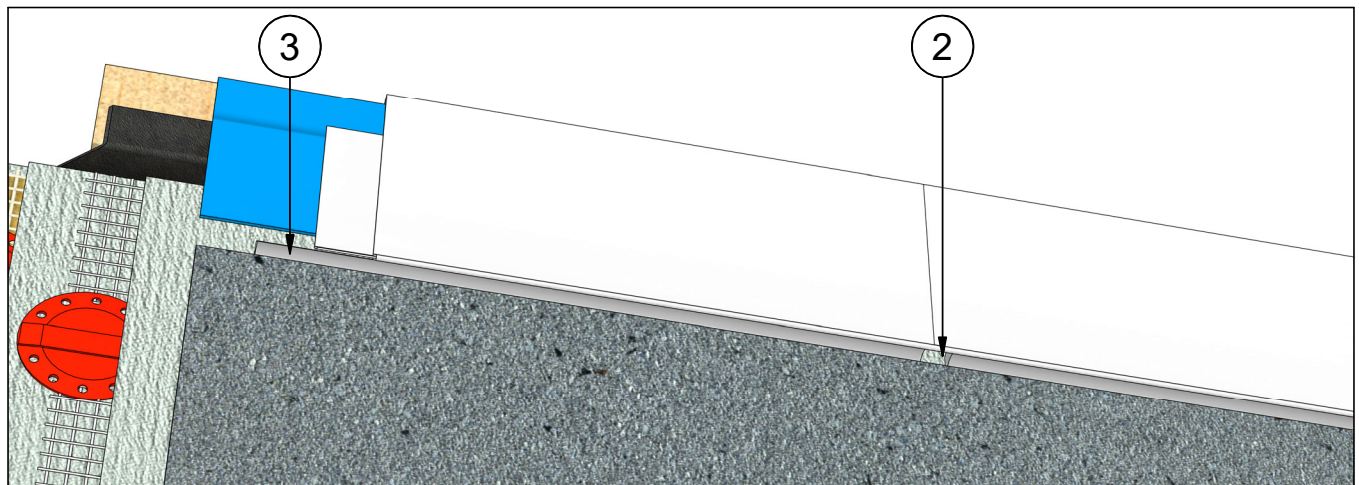

AIR SPACE & SEALANT SPECIFICS

- 1 Provide a 1/2" (13mm) Air Space**
 The air space at the top of the wall allows for the wall assembly to expand & contract freely without damaging the parapet.
- 2 Provide a 1/2" (13mm) Air Space**
 When the parapet has a seam in the metal flashing, the sealant should be broken to allow the system to vent freely.
- 3 Sealant Attached to Base Coat**
 The sealant is attached directly to the base layer. The finish coat is then applied to complete the wall; it abuts against the sealant.

DURABOND.

Durabond details are offered to assist in the development of project specific details; principles and variables incorporated in all details are the sole responsibility of the project professional(s).

SOFFIT INTERFACE WITH OVERHANG

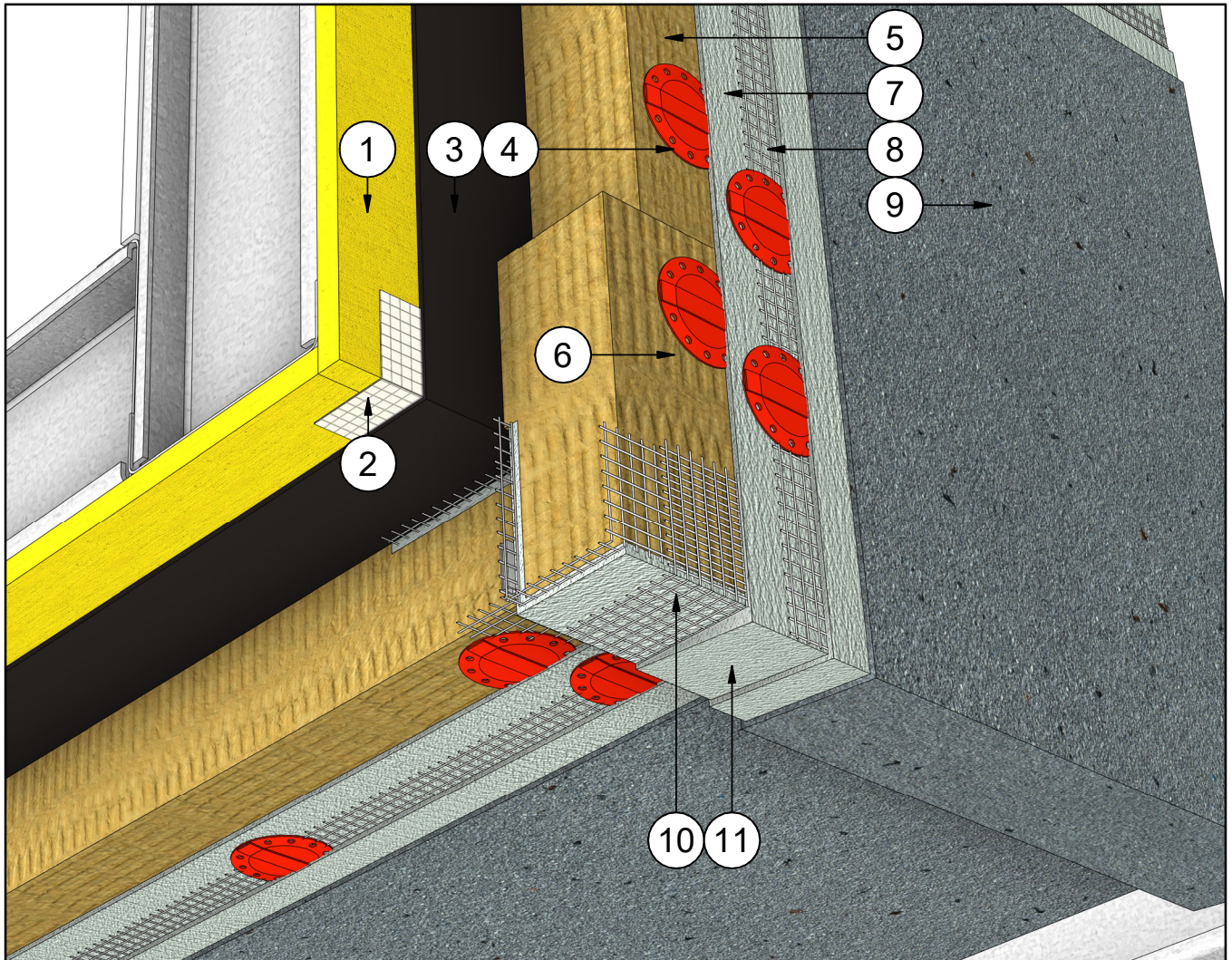

- | # | Note Text |
|----|---|
| 1 | Steel Studs Frame & Sheathing |
| 2 | Barrier Seam Tape (Embedded in WRB) |
| 3 | WRB - Water Resistant Barrier |
| 4 | Insulation Fastener w/ Plate |
| 5 | Equalite Select Insulation Board |
| 6 | Equalite Select Vent Board |
| 7 | Base Coat |
| 8 | Fibreglass Reinforcing Mesh (Embedded in Base Coat) |
| 9 | Finish Coat |
| 10 | Fiberglass Corner Mesh (Embedded in Base Coat) |
| 11 | Base Coat Sloped for Drainage |
| 12 | Durex Continuous Drainage Vent |

DURABOND.

Durabond details are offered to assist in the development of project specific details; principles and variables incorporated in all details are the sole responsibility of the project professional(s).

SOFFIT INTERFACE WITH OVERHANG

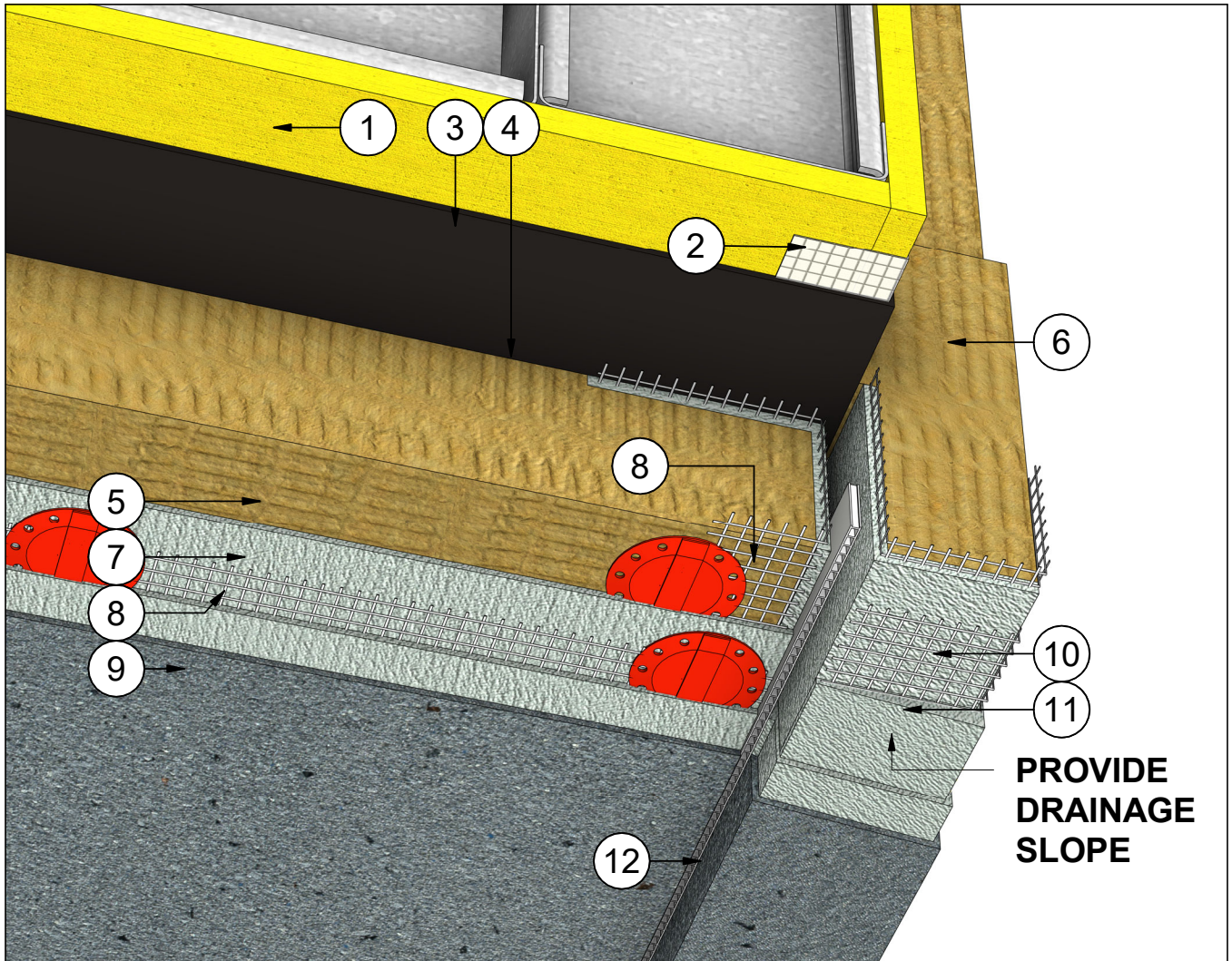

Note Text

- 1 Steel Studs Frame & Sheathing
- 2 Barrier Seam Tape (Embedded in WRB)
- 3 WRB - Water Resistive Barrier
- 4 Insulation Fastener w/ Plate
- 5 Equalite Select Insulation Board
- 6 Equalite Select Vent Board
- 7 Base Coat
- 8 Fibreglass Reinforcing Mesh (Embedded in Base Coat)
- 9 Finish Coat
- 10 Fibreglass Corner Mesh (Embedded in Base Coat)
- 11 Base Coat Sloped for Drainage
- 12 Durex Continous Drainage Vent

DURABOND.

Durabond details are offered to assist in the development of project specific details; principles and variables incorporated in all details are the sole responsibility of the project professional(s).

SOFFIT INTERFACE WITH OVERHANG

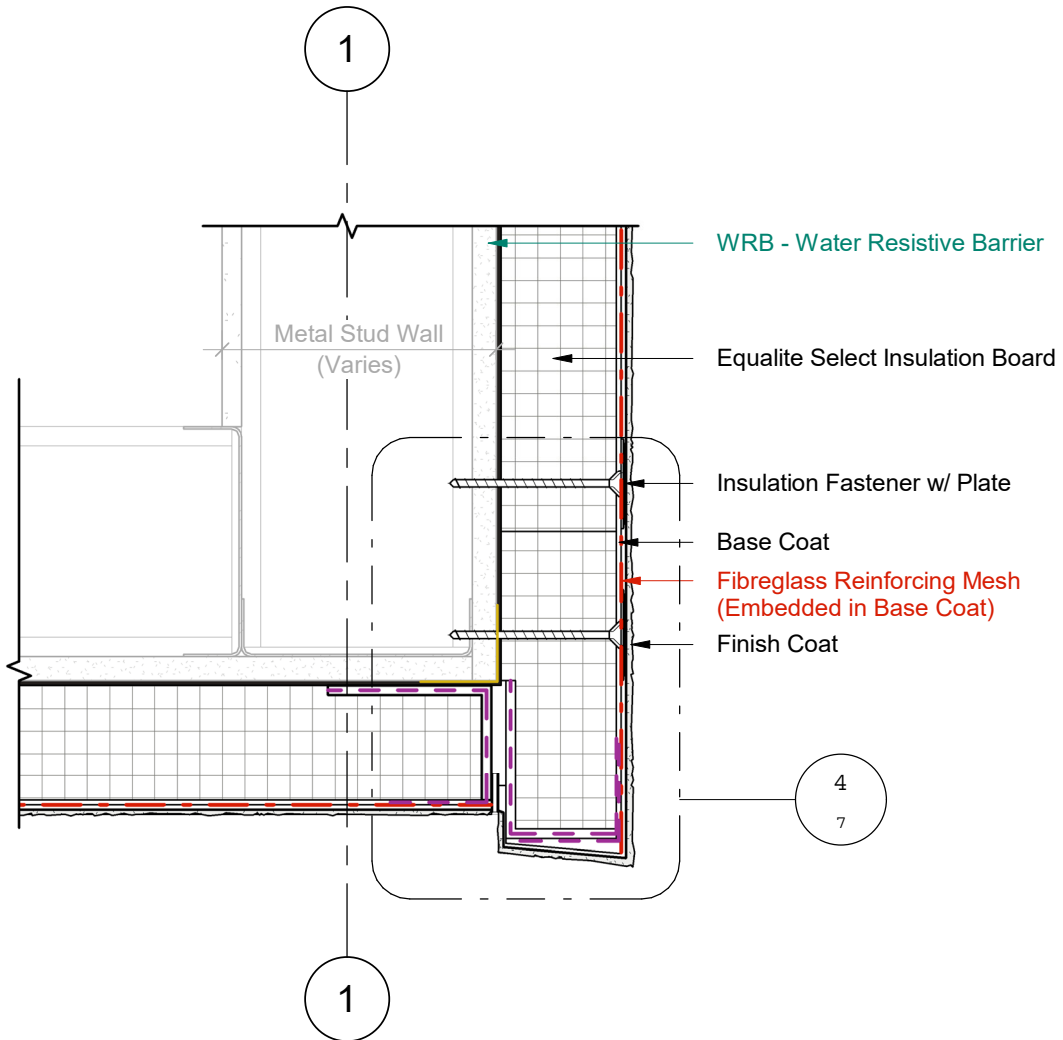

1 Wall Section
3 Scale = 1 : 5



Durabond details are offered to assist in the development of project specific details; principles and variables incorporated in all details are the sole responsibility of the project professional(s).

SOFFIT INTERFACE WITH OVERHANG

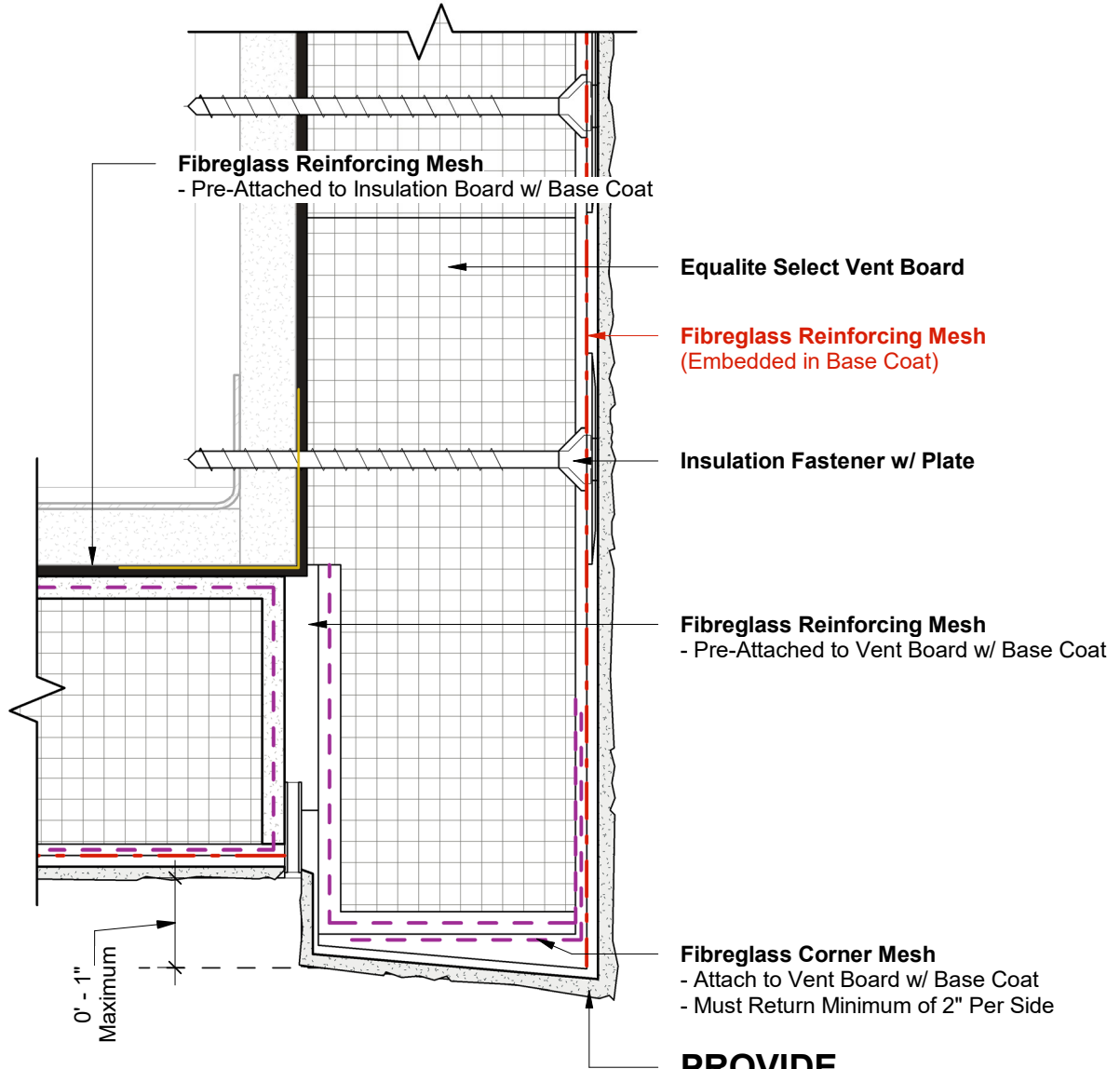

1 Wall Section - Callout 1
4 Scale = 6" = 1'-0"

Durabond details are offered to assist in the development of project specific details; principles and variables incorporated in all details are the sole responsibility of the project professional(s).

SOFFIT INTERFACE WITH FLUSH JOINT

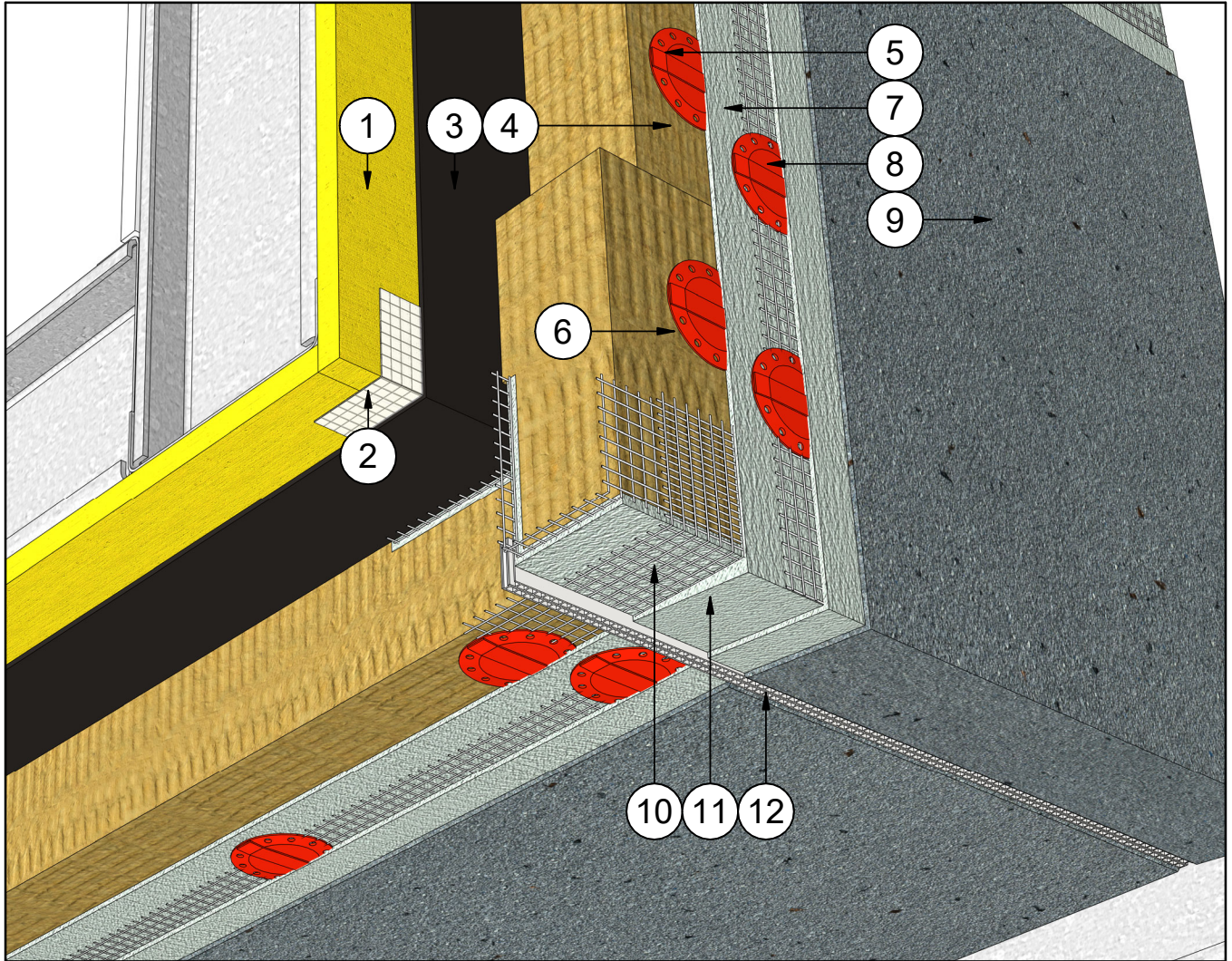

| # | Note Text |
|----|---|
| 1 | Steel Studs Frame & Sheathing |
| 2 | Barrier Seam Tape (Embedded in WRB) |
| 3 | WRB - Water Resistant Barrier |
| 4 | Insulation Fastener w/ Plate |
| 5 | Equalite Insulation Board |
| 6 | Equalite Boundary Board |
| 7 | Base Coat |
| 8 | Fiberglass Reinforcing Mesh (Embedded in Base Coat) |
| 9 | Finish Coat |
| 10 | Fiberglass Corner Mesh (Embedded in Base Coat) |
| 11 | Base Coat Sloped for Drainage |
| 12 | Durex Continuous Drainage Vent |

DURABOND.

Durabond details are offered to assist in the development of project specific details; principles and variables incorporated in all details are the sole responsibility of the project professional(s).

SOFFIT INTERFACE WITH FLUSH JOINT

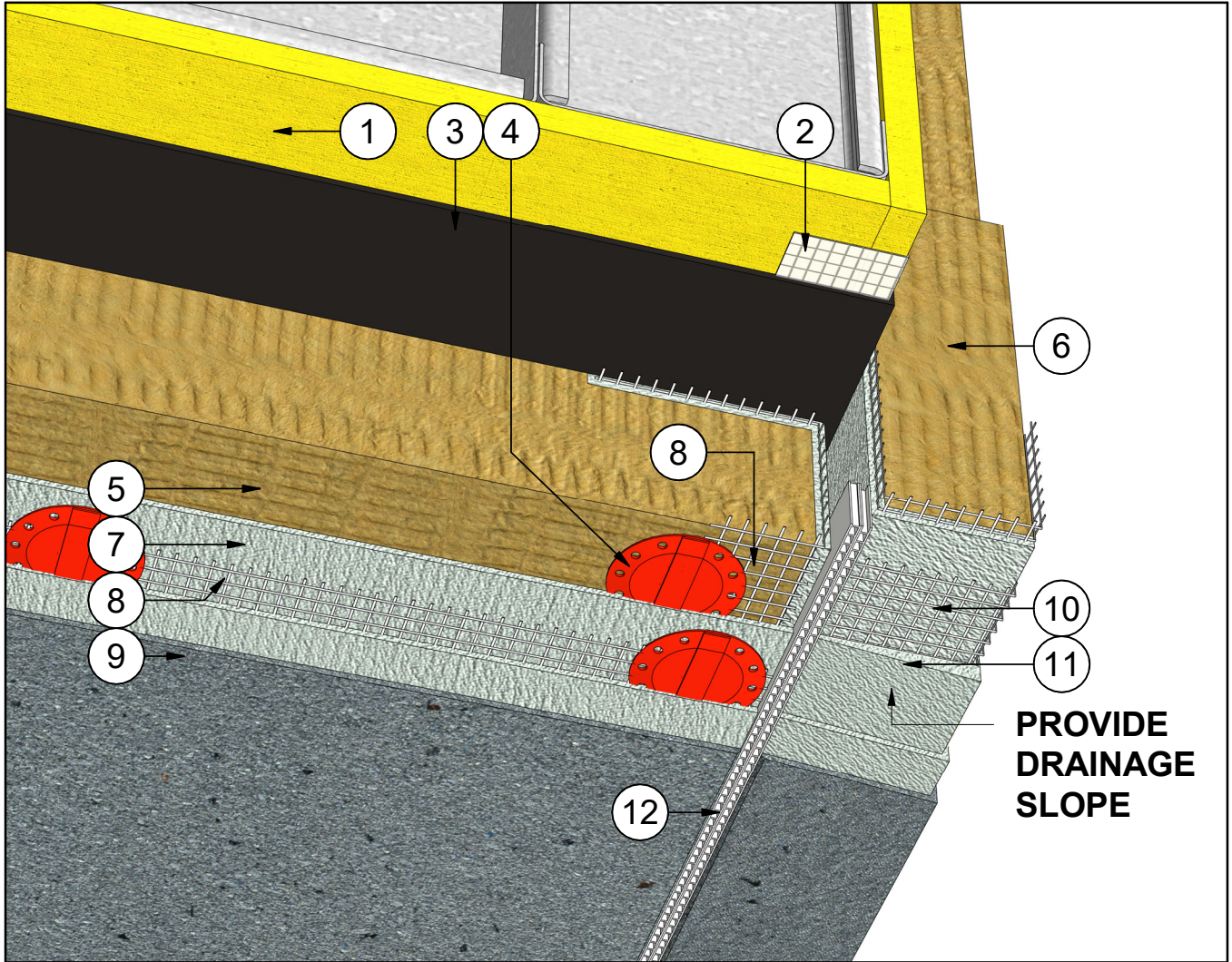

| # | Note Text |
|----|---|
| 1 | Steel Studs Frame & Sheathing |
| 2 | Barrier Seam Tape (Embedded in WRB) |
| 3 | WRB - Water Resistive Barrier |
| 4 | Insulation Fastener w/ Plate |
| 5 | Equalite Insulation Board |
| 6 | Equalite Boundary Board |
| 7 | Base Coat |
| 8 | Fibreglass Reinforcing Mesh (Embedded in Base Coat) |
| 9 | Finish Coat |
| 10 | Fibreglass Corner Mesh (Embedded in Base Coat) |
| 11 | Base Coat Sloped for Drainage |
| 12 | Durex Continuous Drainage Vent |

DURABOND.

Durabond details are offered to assist in the development of project specific details; principles and variables incorporated in all details are the sole responsibility of the project professional(s).

SOFFIT INTERFACE WITH FLUSH JOINT

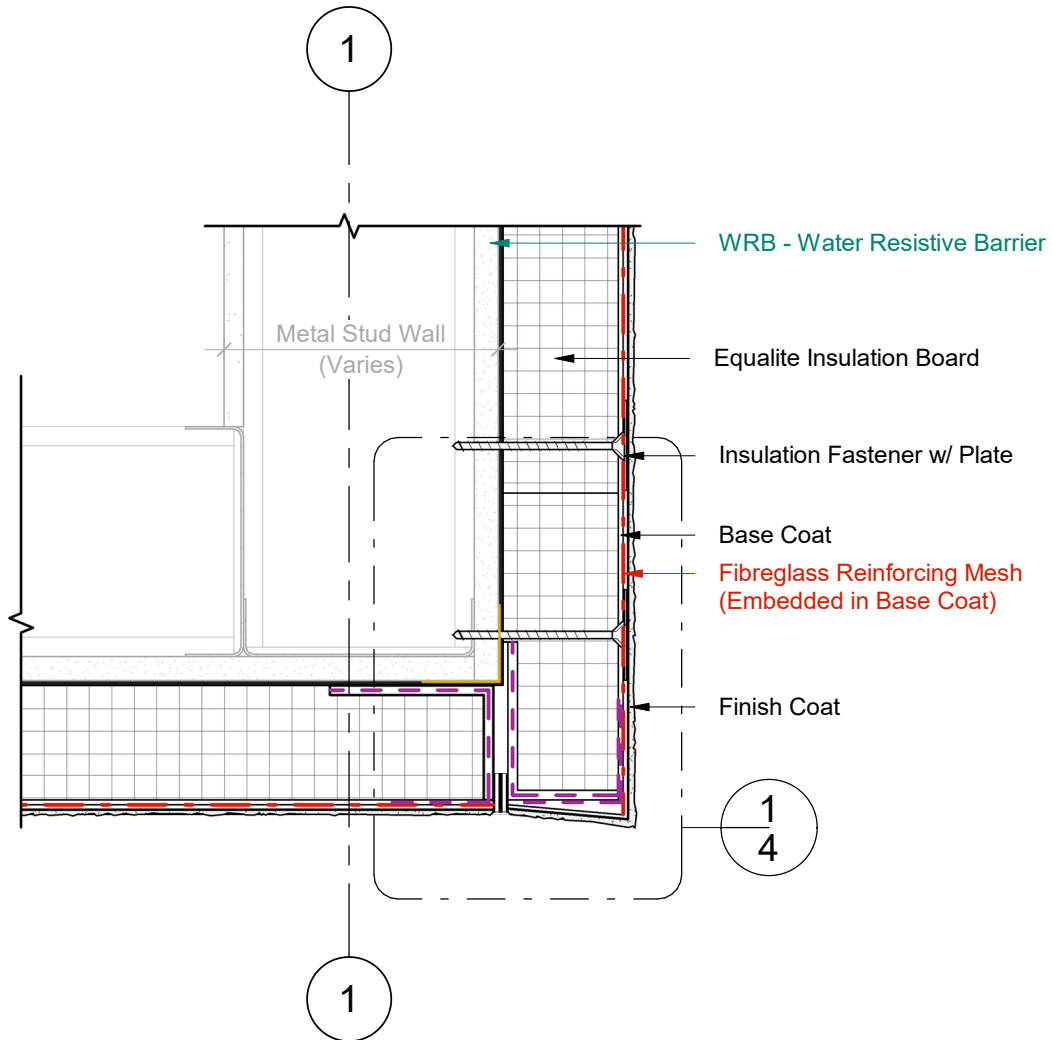

1 Wall Section
3 Scale = 1 : 5

SOFFIT INTERFACE WITH FLUSH JOINT

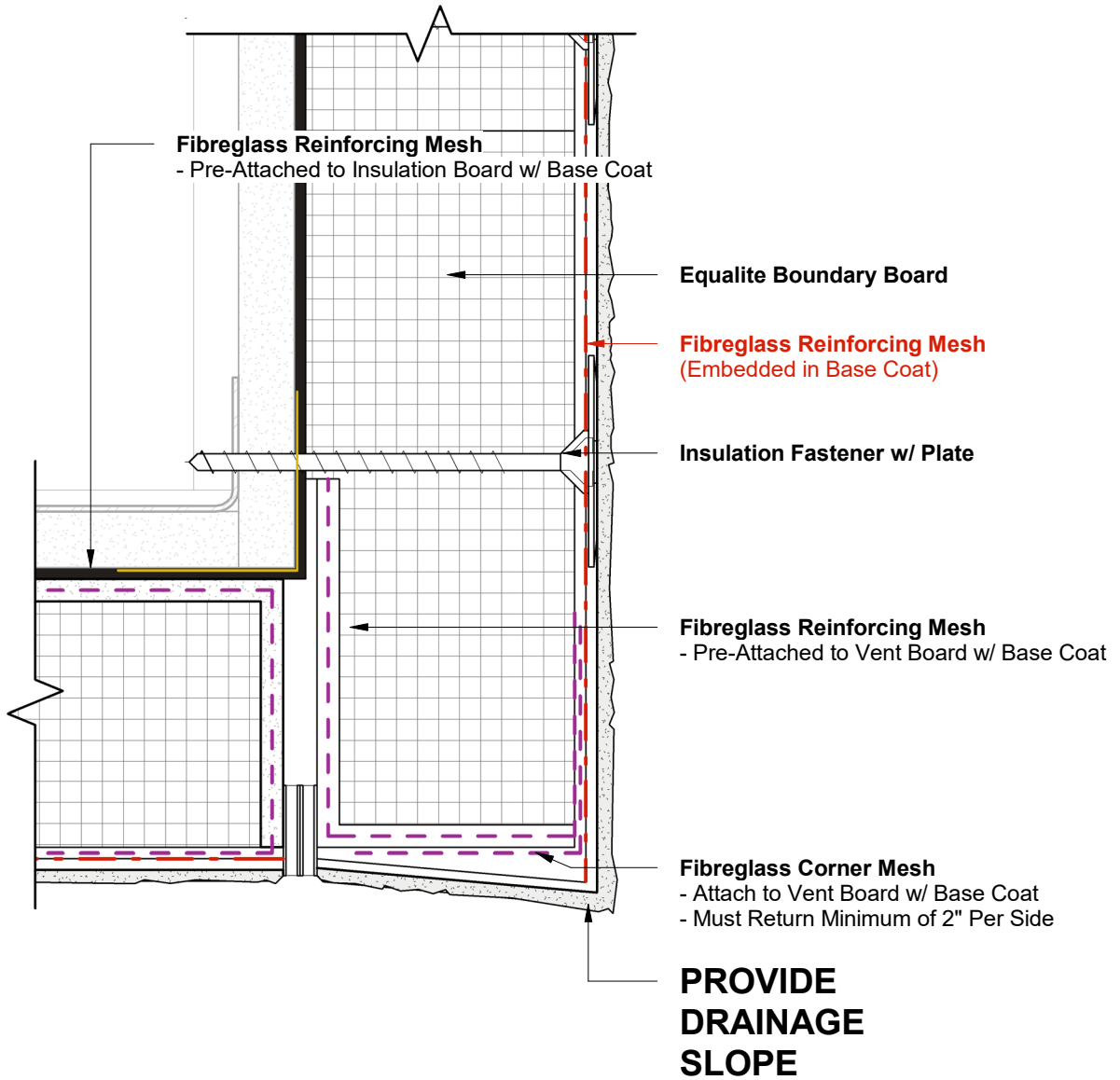

1 Wall Section - Callout 1
4 Scale = 6" = 1'-0"

STUCCO SOFFIT INTERFACE WITH FLUSH JOINT

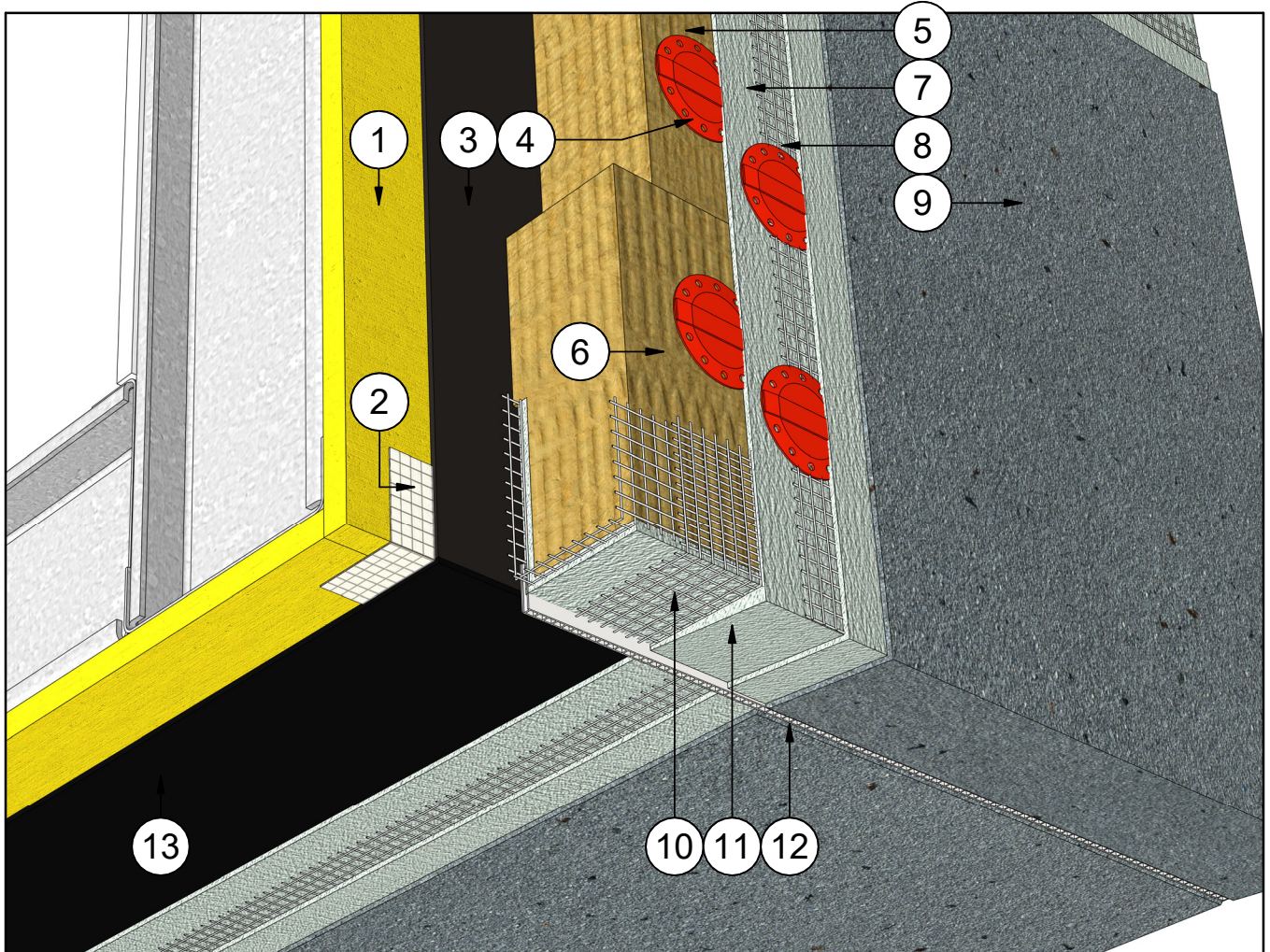

| # | Note Text |
|----|---|
| 1 | Steel Studs Frame & Sheathing |
| 2 | Barrier Seam Tape (Embedded in WRB) |
| 3 | WRB - Water Resistive Barrier |
| 4 | Insulation Fastener w/ Plate |
| 5 | Equalite Insulation Board |
| 6 | Equalite Boundary Board |
| 7 | Base Coat |
| 8 | Fibreglass Reinforcing Mesh (Embedded in Base Coat) |
| 9 | Finish Coat |
| 10 | Fibreglass Corner Mesh (Embedded in Base Coat) |
| 11 | Base Coat Sloped for Drainage |
| 12 | Durex Continuous Drainage Vent |
| 13 | Air & Vapour Barrier |

DURABOND.

Durabond details are offered to assist in the development of project specific details; principles and variables incorporated in all details are the sole responsibility of the project professional(s).

STUCCO SOFFIT INTERFACE WITH FLUSH JOINT

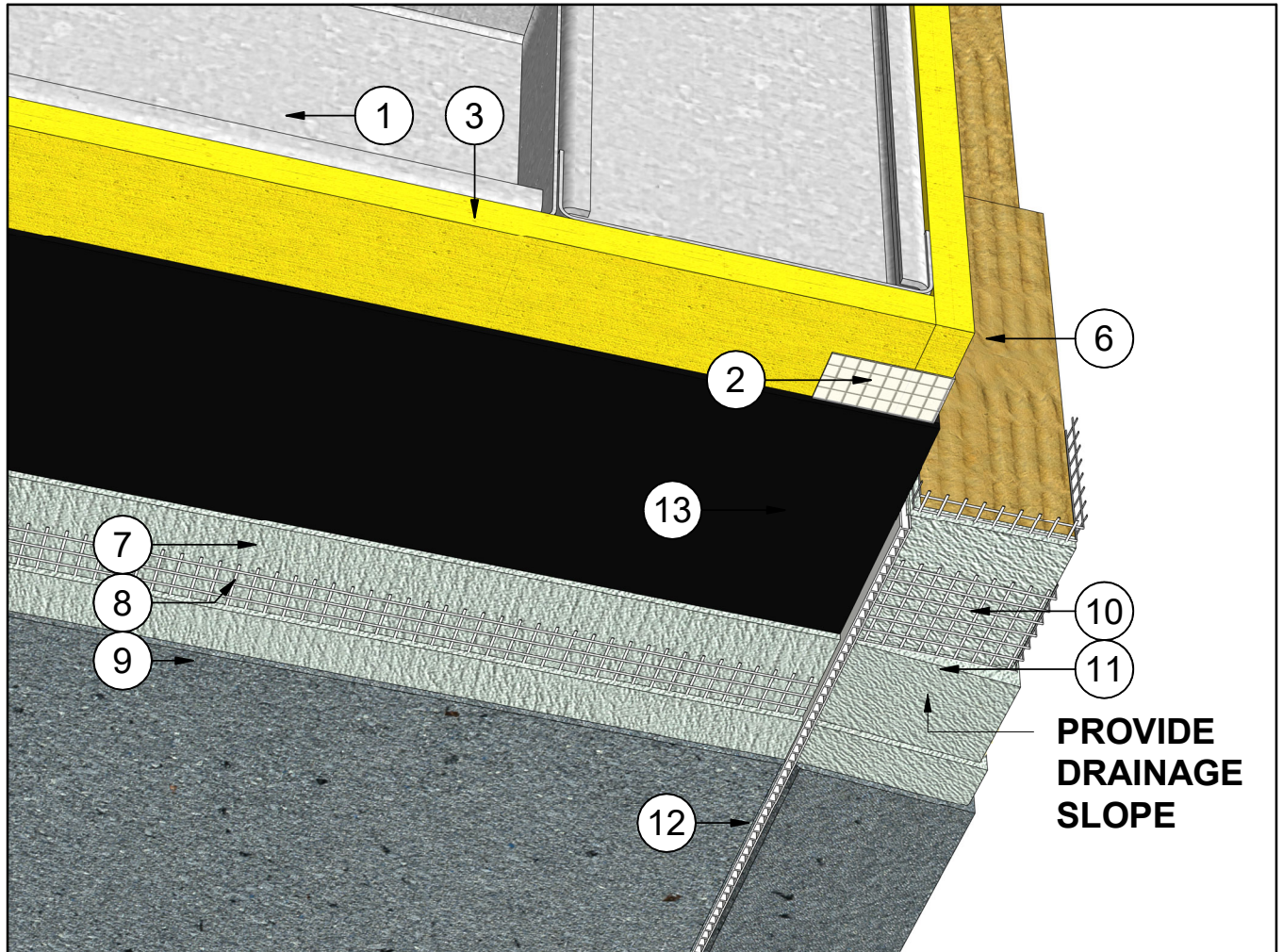

Note Text

- 1 Steel Studs Frame & Sheathing
- 2 Barrier Seam Tape (Embedded in WRB)
- 3 WRB - Water Resistive Barrier
- 4 Insulation Fastener w/ Plate
- 5 Equalite Insulation Board
- 6 Equalite Boundary Board
- 7 Base Coat
- 8 Fibreglass Reinforcing Mesh (Embedded in Base Coat)
- 9 Finish Coat
- 10 Fibreglass Corner Mesh (Embedded in Base Coat)
- 11 Base Coat Sloped for Drainage
- 12 Durex Continuous Drainage Vent
- 13 Air & Vapour Barrier

DURABOND.

Durabond details are offered to assist in the development of project specific details; principles and variables incorporated in all details are the sole responsibility of the project professional(s).

STUCCO SOFFIT INTERFACE WITH FLUSH JOINT

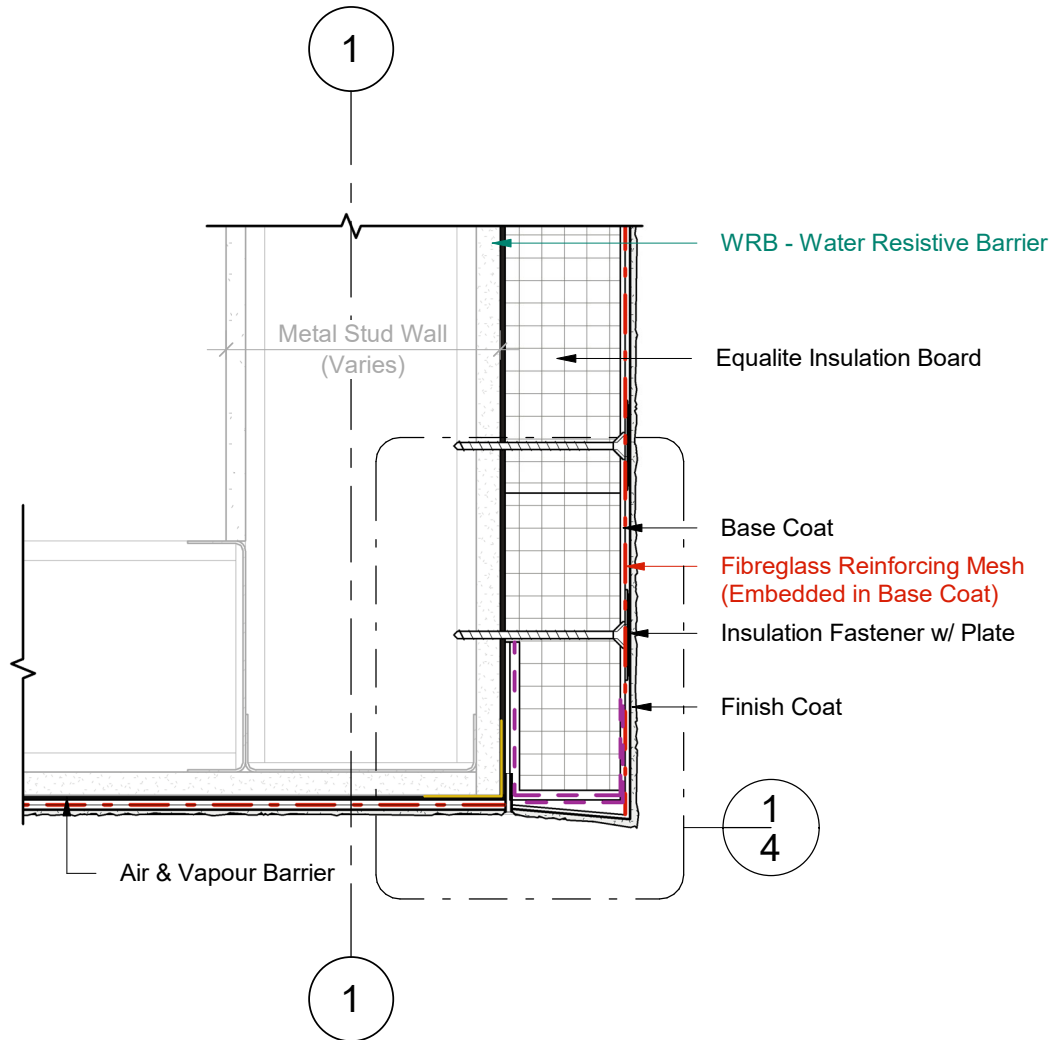

1 Wall Section
3 Scale = 1 : 5

STUCCO SOFFIT INTERFACE WITH FLUSH JOINT

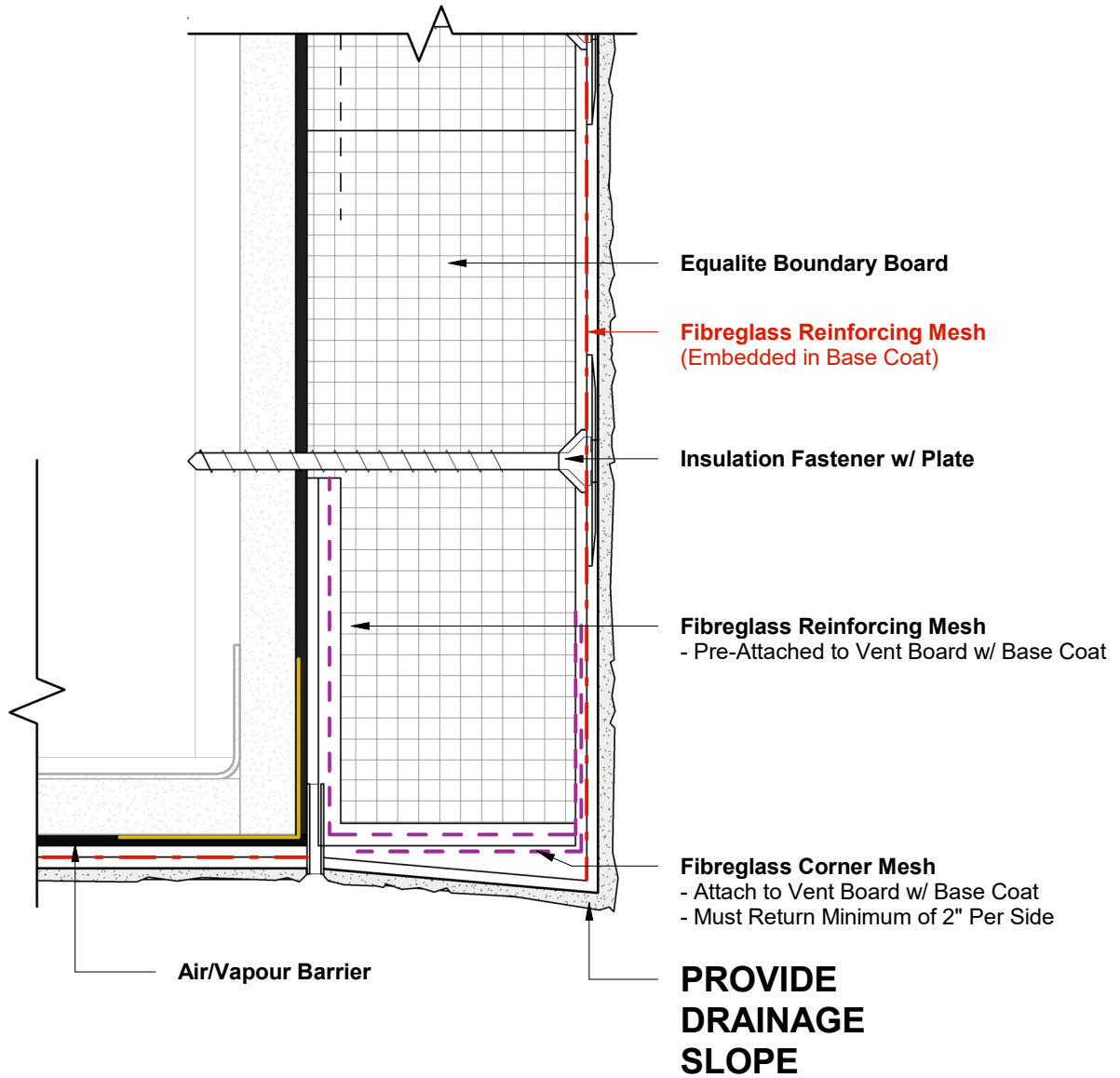

1 Wall Section - Callout 1
4 Scale = 6" = 1'-0"